

catalogue

2020_01

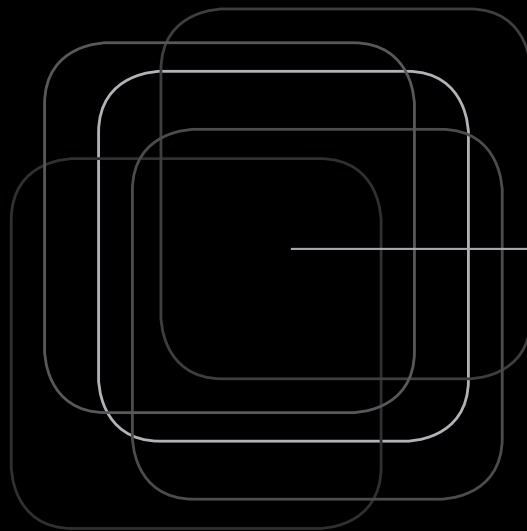





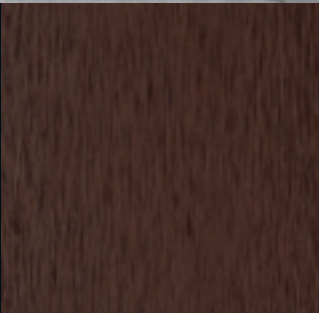
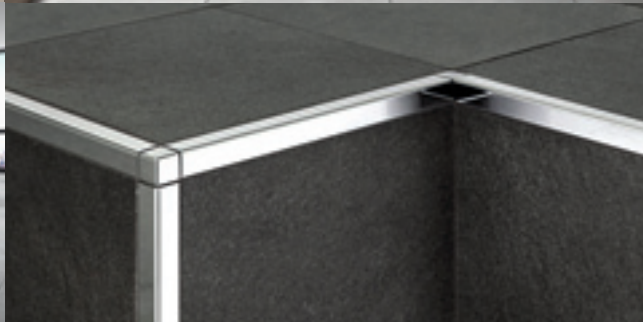

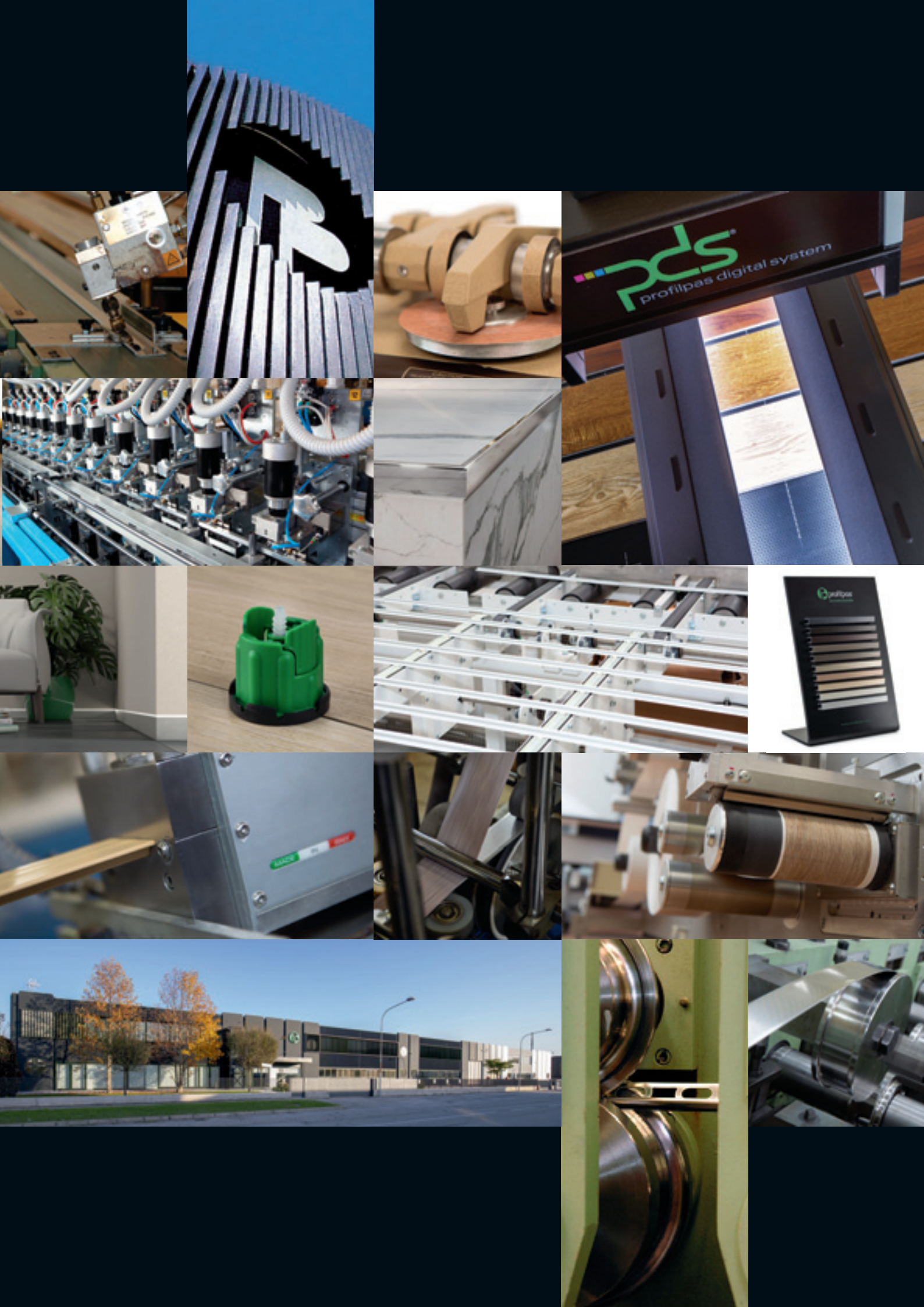





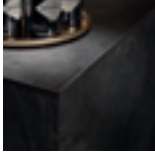
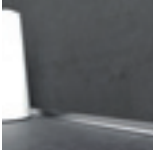

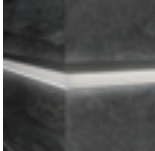

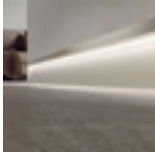
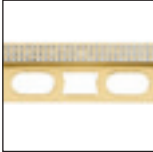







Design is our best profile.

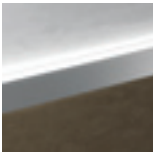
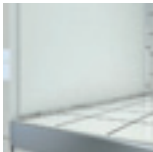
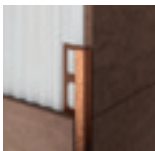

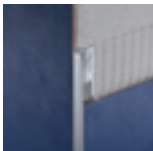
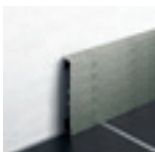
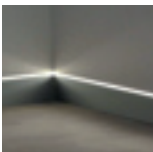

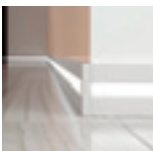
Index

profilpas design		XL DESIGN CERFIX® PROLIST V-S page 21		M DESIGN METAL LINE AF page 40		ICEBERG page 58	
		XL DESIGN CERFIX® PROANGLE AQ - D PROANGLE Q page 24		M DESIGN METAL LINE AL page 40		ELECTRICAL COMPONENTS page 59	
		XL DESIGN PROLIGHT PROLIST Q page 27		C DESIGN CERFIX® PRODECOR DJKC page 42			
		XL DESIGN PROLIGHT METALLINE S page 28		C DESIGN CERFIX® PROSTYLE UKGC page 43	listellos and decorative profiles		CERFIX® PROLIST page 63
		TREND COLOR STONE CERFIX® PROANGLE - PROTRIM IP page 29		OMEGA DESIGN CERFIX® PROANGLE Q - PROLIST page 45			
		TREND COLOR STONE METAL LINE page 32			external corners profiles		CERFIX® PROTRIM page 67
		TREND COLOR LIGHT CERFIX® PROANGLE - PROANGLE Q page 33	prolight			PROANGLE Q pag. 49	
		X DESIGN CERFIX® PROLIST page 35			PROLIST page 51		CERFIX® PROANGLE F page 74
		X DESIGN CERFIX® PROANGLE Q page 35		PROSTEP PROTECT page 53		CERFIX® PROANGLE page 75	
	I DESIGN METAL LINE page 37		METAL LINE 88/16L/A page 56		CERFIX® PROANGLE Q page 77		
	M DESIGN CERFIX® PROANGLE AX page 39		METAL LINE 89 page 57		CERFIX® PROTRIM IP page 80		



CERFIX®
PROCORNER M
page 81

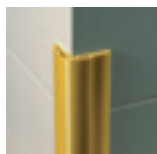

CERFIX®
PROCORNER P
page 83



CERFIX®
PROBORD
ILN
page 84



CERFIX®
PROBORD
IL
page 84



CERFIX®
PROTOP
page 85

profiles and installation systems for bathrooms



THIN
DRAIN
page 97

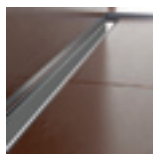

SLIM
DRAIN
page 99

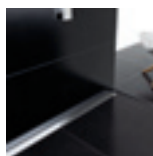

SMART
DRAIN
page 101



Q-DRAIN
page 103



WPSTOP
page 106



GLASS
PROFILE
page 107



SANIBORD
page 115



CERFIX®
PRODECOR
page 121



CERFIX®
PROSTYLE
page 122

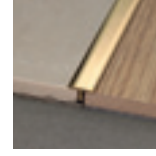

PROJOINT
T
page 123



PROJOINT
R
page 124

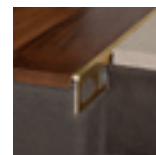

PROJOINT
M
page 124



PROJOINT
U
page 125



PROJOINT
page 125



PROCLASSIC R
page 126



PROCLASSIC F
page 129

internal corners profiles

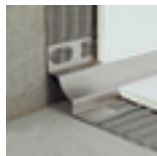

CERFIX®
PROROUND
M
page 87



CERFIX®
PROROUND
GINI/ GIC/
page 89



CERFIX®
PROROUND
P
page 90

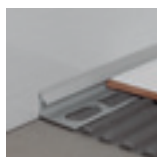

CERFIX®
PROINT
page 91



CERFIX®
PROROUND
B
page 92

profiles for floors of same height



CERFIX®
PROANGLE
page 119



CERFIX®
PROANGLE
B
page 120



CERFIX®
PRODECOR
DJ
page 121

profiles for floors of different height

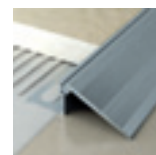

PRONIVEL
N
page 133



PRONIVEL
P
page 134



PRONIVEL
L
page 135



PRONIVEL
PB
page 135



PRONIVEL
WOOD
page 136



PRONIVEL
M
page 136



PROLEVEL
HIGH
page 137



PROLEVEL
MEDIUM
page 141



PROLEVEL
THIN
page 143

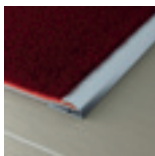

PROLOCK
page 143



CERFIX®
PROJJOINT DIL
NJ
page 145



CERFIX®
PROJJOINT DIL
NL
page 146



CERFIX®
PROJJOINT DIL
NF
page 146



CERFIX®
PROJJOINT DIL
NAN
page 147



CERFIX®
PROJJOINT DIL
NPAN
page 147



CERFIX®
PROJJOINT DIL
NIN
page 148



CERFIX®
PROJJOINT DIL
NTA - NTI - NTO
page 148



CERFIX®
PROJJOINT DIL
NZA
page 149



CERFIX®
PROJJOINT DIL
NZS
page 149



CERFIX®
PROJJOINT DIL
STA - STI - STO
page 150



CERFIX®
PROJJOINT
DIL PBE
page 151



CERFIX®
PROJJOINT
DIL PBH - PAS
page 152



CERFIX®
PROCOVER
FLEX
page 154



CERFIX®
PROCOVER FIX
page 154



CERFIX®
PROCOVER
page 155

waterproofing,
drainage,
uncoupling



WPstop
page 159

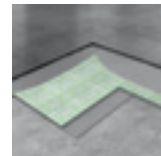

WPstop3
page 160

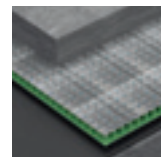

WPstop
Drain 10
page 161

profiles
for balconies
and terraces



CERFIX®
PROTEC
CPCV - CPCI
page 163



CERFIX®
PROTEC
CPCV/30/
page 165

movement
joints



CERFIX®
PROJJOINT DIL
NE
page 145



CERFIX®
PROTEC
CPHA - CPHV
page 166



CERFIX®
PROTEC
CPGV
page 167



CERFIX®
PROTEC
CPNV
page 168



CERFIX®
PROTEC
CPEV - CPEI
page 169

profiles for wooden, laminate and LVT floors



UNISYSTEM
PLUS
page 193

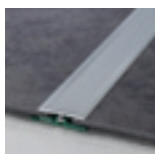

PROFIX
THIN
page 203

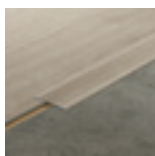

PRESTOWOOD
22/- 50/- 63/
page 205

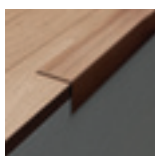

PRESTOWOOD
74/- 58/- 73/
page 207



RC
page 208

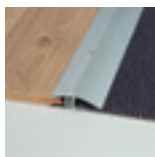

ALFIX® 616
page 209



ALFIX 46
page 210



CERFIX®
PROJOINT
PRONIVEL
page 211



PROSTEP
PROTECT
page 213

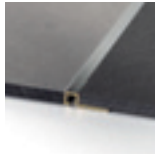

CERFIX®
PROTRIM
PROANGLE
PROANGLE Q
page 214



CERFIX®
PROROUND M
PROINT
page 215



PVC LINE
8608
page 216

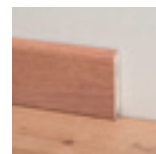

PVC
LINE 8605 - 8612
page 217



PDS
page 219

bendable profiles

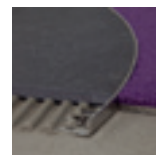

PROANGLE
FLEX
page 223



PRODECOR
FLEX
page 224



PROTRIM
FLEX
page 224



PROJOINT
FLEX
page 225



TERMINAL
FLEX
page 226



PRONIVEL
FLEX
page 226



PROSTEP
FLEX
page 226

stair nosing profiles



CERFIX®
PROSTEP
page 173



CERFIX®
PROSTEP
SIR - SAR
page 175



CERFIX®
PROTECT
page 179

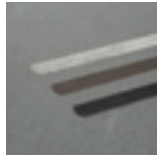

SAFETY
STEP
page 187

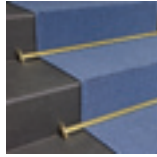

PROSTAIR
page 189

Index



METAL LINE
90FX
page 227



PROFLEX
MACHINE
page 228



METAL LINE
93/
page 240

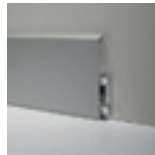

METAL LINE
95/
page 241

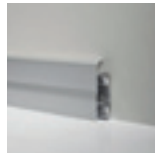

METAL LINE
96/
page 242

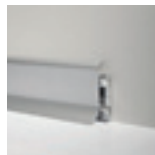

METAL LINE
98/7
page 243

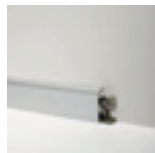

METAL LINE
97/4
page 244

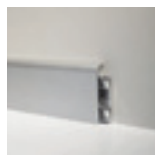

METAL LINE
97/7
page 245



METAL LINE
97/8
page 246



PVC LINE
8612/10
pag. 252



PVC LINE
8614
pag. 252

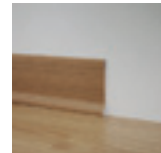

PVC LINE
8600 - 8610 - 8611
page 253

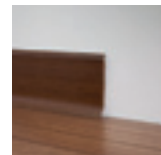

PVC LINE
8598 - 8596
page 254

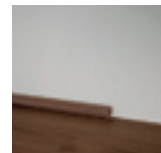

PVC LINE
8580
page 254

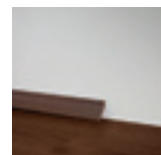

PVC LINE
8582
page 254

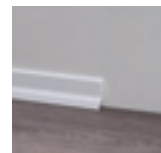

PVC LINE
8602
page 255

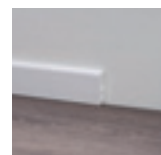

PVC LINE
8603
page 256

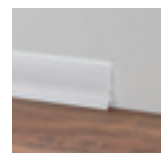

PVC LINE
8607
page 257



PVC LINE
148 - 172 - 173
page 258



PVC LINE
170 - 169 - 171
page 259

metal line



METAL LINE
90/ - SILENT
page 231



METAL LINE
790/
page 234

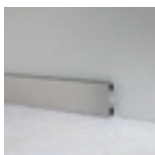

METAL LINE
89/ - 89/613
page 235-236



METAL LINE
91/
page 236

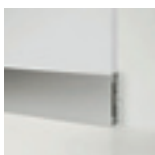

METAL LINE
87/6 - 88/6
page 237

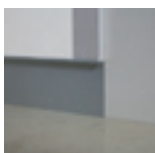

METAL LINE
100/
page 239

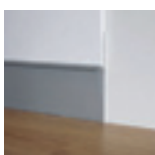

METAL LINE
101/74
page 239



METAL LINE
92/
page 240

pvc line

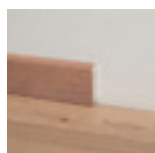



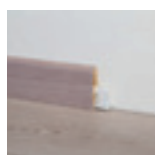









PVC LINE
8605
page 249



PVC LINE
8608
page 250



PVC LINE
8613
pag. 251

<p>DIY profiles</p>	 <p>DIY PROFILES page 261</p>	
<p>supports for raised floors</p>	 <p>PP LEVEL DUO® COMPLETE SUPPORT page 269</p>	 <p>PROTILER page 283</p>
	 <p>PP LEVEL DUO® MODULAR SUPPORT page 271</p>	 <p>SPACERS page 285</p>
	 <p>PP LEVEL DUO® DOUBLE JOIST SYSTEM page 273</p>	 <p>ACCESSORIES FOR INSTALLATION page 286</p>
	 <p>PP LEVEL FIX COMPLETE SUPPORT page 275</p>	<p>merchandising for the point of sale</p>  <p>MERCHANDISING FOR THE POINT OF SALE page 289</p>
	 <p>PP LEVEL MINI page 276</p>	
	 <p>PP LEVEL DUO® ACCESSORIES page 277</p>	<p>index by item</p> <p>page 299</p>
<p>accessories for installation</p>	 <p>KLIC LEVEL page 281</p>	

finishes

stainless steel

	SS polished stainless steel AISI 304 DIN 1.4301
	SS3 polished stainless steel AISI 316 DIN 1.4404
	SS0 polished stainless steel AISI 430 DIN 1.4016
	SSP superpolished stainless steel AISI 304 DIN 1.4301
	SSS satin stainless steel AISI 304 DIN 1.4301
	SSB sandblasted stainless steel AISI 304 DIN 1.4301
	satin stainless steel AISI 430 - DIN 1.4016

brass

	BN natural
	BP polished
	BCP chromium plated
	BPP plated polished
	BCG 24kt gold plated

aluminium

	AN natural
--	----------------------

anodised aluminium

	AS silver
	AG gold
	ASG sand gold
	AT titanium
	AB bronze
	ABE bronze elox
	ABL black
	platinum
	titanium
	brown
	dark brown
	carbon

bright polished aluminium

	ABPS silver
	ABPG gold
	ABPT titanium
	ABPC copper

bright satin aluminium

	ABSS silver
	ABSG gold
	ABST titanium
	ABSG copper
	ABSB black

bright scratched aluminium

	ABBS silver
--	-----------------------

colour-coated aluminium

	AC RAL 9003 matt white
	AC RAL 9003 white
	AC RAL 9010 matt white
	AC RAL 9010 polished white
	AC RAL 9001 cream white
	AC RAL 1013 pearl white
	AC RAL 1019 beige grey
	AC RAL 7030 stone grey
	AC RAL 7035 light grey
	AC RAL 3002 red
	AC RAL 9005 black
	AC RAL 8019 dark brown
	AC RAL 7038 ash grey
	AC RAL 7038 ash grey embossed
	AC RAL 9006 metal grey
	AC RAL 9007 aluminium grey
	AC anthracite grey
	AC rust
	AC ancient grey
	AC beige
	AC sand
	AC greige
	AC stone
	AC grey
	AC bronze
	AC dark brown
	AC perla
	AC ecru
	AC oliva
	AC zafferano
	AC kaki
	AC peach
	AC mahogany
	AC seppia
	AC bistro
	AC ardesia
	AC white ST

	AC black ST
	AC concrete white
	AC concrete crete
	AC concrete graphite
	AC concrete smoke
	AC concrete mud
	AC concrete sand
	AC metal dark
	AC metal light
	AC solid white

covered aluminium Alcrom® Plus

	02
	04
	05
	07
	08
	09
	10
	11
	12
	13
	14
	15
	18
	19
	20
	25
	26
	30
	31
	32
	34
	35
	36
	37
	38
	39
	40
	41
	42

	43
	44
	45
	46
	47
	48
	50
	60
	65
	70
	71
	72
	73
	74
	75
	76
	77
	78
	79
	80
	81
	89
	90
	91
	92
	93
	94
	95
	351
	363
	372
	374
	490
	560
	580
	590
	665
	670
	716
	848

	866
	884
	912
	951
	975
	1003
	1006
	1009
	1012
	1015
	1018
	1021
	1024
	1027
	1030
	1033
	1036
	1039
	1042
	1045
	1048
	1051
	1054
	1057
	1060
	1063
	1066
	1069
	1072
	1075
	1078
	1081
	1084
	1087
	1090
	1093
	1096
	1099
	1102
	1105

	1108
	1111
	1114
	1201
	1202
	1203
	1204
	1205
	1206
	1207
	1208
	1209
	1210
	1211
	1212
	1213
	1214
	1215
	1216
	1217

PVC Line

	96 - white
	97 - black
	98 - silver
	99 - satin silver
	100 - satin steel

solid wood

	natural oak
	country oak
	antique oak
	walnut
	mahogany
	cherry
	wengè
	natural beech

PVC

	code 400 snow white
	code 402 white
	code 404 9001 cream white
	code 406 RAL 1015 - ivory

	code 407 sand
	code 408 RAL 1019 - beige grey
	code 410 RAL 7030 - stone grey
	code 412 RAL 7038 - ash grey
	code 414 RAL 7035 - light grey
	code 416 anthracite
	code 418 blue
	code 420 pastel blue
	code 422 light green
	code 424 RAL 3002 - red
	code 426 RAL 9005 - black
	code 428 RAL 1023 - yellow
	code 430 pastel pink
	code 432 beige bahama
	code 434 peach
	code 436 caramel
	code 438 brown
	code 440 dark brown
	code 442 coral red
	code 444 raw sienna
	code 446 terracotta

superpolished PVC

	code 450 snow white
	code 452 RAL 9001 - cream white
	code 454 RAL 1015 - ivory
	code 456 RAL 1019 - beige grey
	code 458 RAL 7030 - stone grey
	code 460 RAL 7038 - ash grey
	code 462 RAL 7035 - light grey
	code 464 pastel blue
	code 466 light green
	code 468 pastel pink
	code 470 beige bahama
	code 472 peach
	code 474 caramel
	code 476 brown

marbled PVC

	code 480 white
	code 482 sand
	code 484 light cream

	code 486 dark cream
	code 488 ivory
	code 490 light beige
	code 492 dark beige
	code 494 pink
	code 496 light blue
	code 498 blue
	code 500 light green
	code 502 dark green
	code 504 dark grey
	code 506 bordeaux
	code 508 travertine

foam PVC

	decor 518
	decor 520
	decor 524
	decor 525
	decor 528
	decor 530
	decor 531
	decor 532
	decor 533
	decor 534
	decor 536
	decor 540
	decor 542
	decor 544
	decor 545
	decor 555 white
	decor 556 light grey
	decor 557 black
	decor 558 anthracite
	decor 559 grey
	decor 561 yellow
	decor 562 green
	decor 563 light blue
	decor 564 red





profilpas design

A line of skirting boards and profiles dedicated to the world of design and architecture. This opens up new possibilities in colour combinations, in the creation of the spaces and in the decoration of modern ceramic coverings.



TREND
COLOR
STONE

TREND
COLOR
LIGHT







xl design

XL Design is a line of profiles for large-size ceramic slabs, which marries lightness with versatility in every kind of covering application. Combined with each other, these profiles enhance both public and private spaces, highlighting the dimensions of the slabs.





AVK/1 chromium-plated brass

Prolist V XL Design AV/1 is a new decorative listello designed to add value to large-size ceramic slabs and highlight their surfaces. Thanks to its protruding section, this profile creates original plays of light, thus becoming a real decorative element. In addition to the different finishes of aluminium, this profile is also available in chromium-plated brass (AVK/1 version).

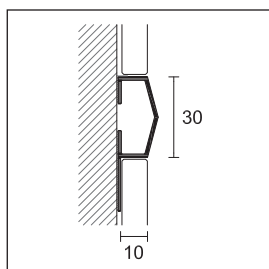

AV/1
AVK/1

NEW PROLIST V - XL DESIGN

length = 280 cm - pack 5 pcs		H
ART.	finishing	10
ALUMINIUM		
AV/1	bright satin titanium	31210
	colour-coated white ST	31211
	colour-coated black ST	31212
euro/m		
CHROMIUM-PLATED BRASS		
AVK/1	chromium plated	31240
euro/m		

individually packed

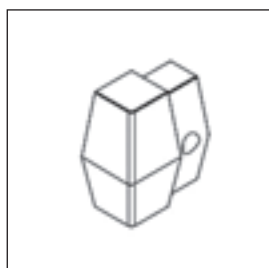

AV/1/E
AVK/1/E

NEW OUTSIDE CORNER

pack 2 pcs		H
ART.	finishing	10
ALUMINIUM		
AV/1/E	bright satin titanium	31213
	colour-coated white ST	31214
	colour-coated black ST	31215
euro/pc		
CHROMIUM-PLATED BRASS		
AVK/1/E	chromium plated	31243
euro/pc		

no partial packaging

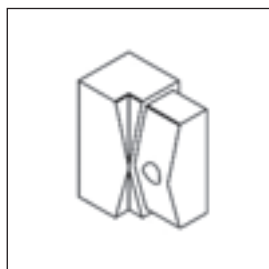

AV/1/I
AVK/1/I

NEW INSIDE CORNER

pack 2 pcs		H
ART.	finishing	10
ALUMINIUM		
AV/1/I	bright satin titanium	31216
	colour-coated white ST	31217
	colour-coated black ST	31218
euro/pc		
CHROMIUM-PLATED BRASS		
AVK/1/I	chromium plated	31244
euro/pc		

no partial packaging



AVK/2 chromium-plated brass

Prolist V XL Design AV/2 is a new decorative listello that, thanks to its hollow section, creates original plays of light, thus becoming a real decorative element. This model is available in aluminium, in different modern finishes, and in chromium-plated brass (AVK/2 version).

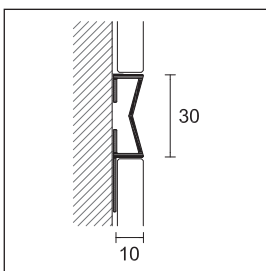

AV/2
AVK/2

NEW PROLIST V - XL DESIGN

length = 280 cm - pack 5 pcs		H
ART.	finishing	10
ALUMINIUM		
	bright satin titanium	31220
AV/2	colour-coated white ST	31221
	colour-coated black ST	31222
euro/m		
CHROMIUM-PLATED BRASS		
AVK/2	chromium plated	31241
euro/m		

individually packed

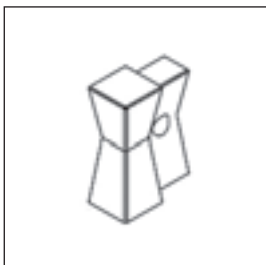

AV/2/E
AVK/2/E

NEW OUTSIDE CORNER

pack 2 pcs		H
ART.	finishing	10
ALUMINIUM		
	bright satin titanium	31223
AV/2/E	colour-coated white ST	31224
	colour-coated black ST	31225
euro/pc		
CHROMIUM-PLATED BRASS		
AVK/2/E	chromium plated	31245
euro/pc		

no partial packaging

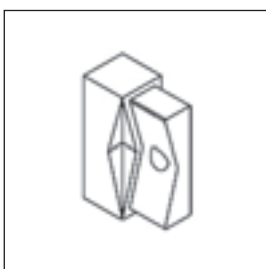

AV/2/I
AVK/2/I

NEW INSIDE CORNER

pack 2 pcs		H
ART.	finishing	10
ALUMINIUM		
	bright satin titanium	31226
AV/2/I	colour-coated white ST	31227
	colour-coated black ST	31228
euro/pc		
CHROMIUM-PLATED BRASS		
AVK/2/I	chromium plated	31246
euro/pc		

no partial packaging

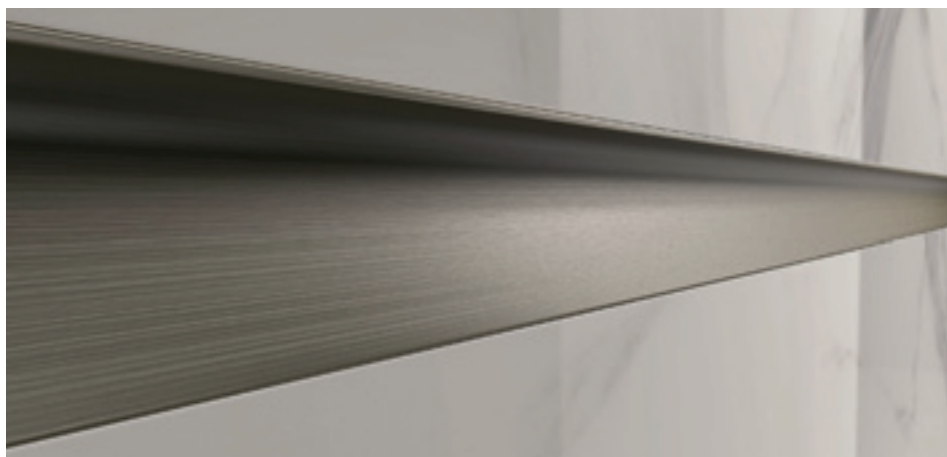

Prolist S XL Design AS is a new decorative listello characterized by a curved section that creates original plays of light and shade, thus highlighting the surfaces' dimensions. It is available in aluminium, in different finishes, and in chromium-plated brass (ASK version) for an extremely elegant and refined result.

AS bright satin titanium aluminium

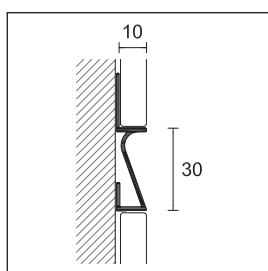

AS
ASK

NEW PROLIST S - XL DESIGN

length = 280 cm - pack 5 pcs		H
ART.	finishing	10
ALUMINIUM		
AS	bright satin titanium	31230
	colour-coated white ST	31231
	colour-coated black ST	31232
<i>euro/m</i>		
CHROMIUM-PLATED BRASS		
ASK	chromium plated	31242
<i>euro/m</i>		

individually packed

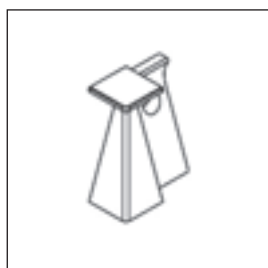

AS/E
ASK/E

NEW OUTSIDE CORNER

pack 2 pcs		H
ART.	finishing	10
ALUMINIUM		
AS/E	bright satin titanium	31233
	colour-coated white ST	31234
	colour-coated black ST	31235
<i>euro/pc</i>		
CHROMIUM-PLATED BRASS		
ASK/E	chromium plated	31247
<i>euro/pc</i>		

no partial packaging

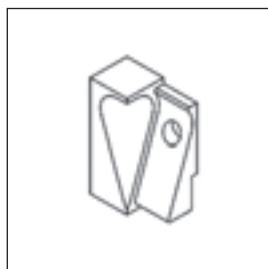

AS/I
ASK/I

NEW INSIDE CORNER

pack 2 pcs		H
ART.	finishing	10
ALUMINIUM		
AS/I	bright satin titanium	31236
	colour-coated white ST	31237
	colour-coated black ST	31238
<i>euro/pc</i>		
CHROMIUM-PLATED BRASS		
ASK/I	chromium plated	31248
<i>euro/pc</i>		

no partial packaging



Proangle XL Design AQ is a new aluminium profile characterized by a distinctive square section, designed to define the external corners of large-size ceramic slabs very clearly. Available in bright polished titanium and white ST, this profile highlights large-size ceramic slabs in a determined but elegant way, creating a special geometrical effect.

AQ bright satin titanium aluminium

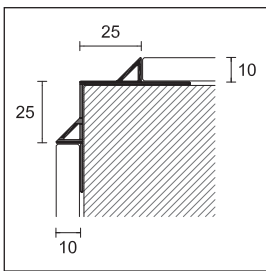

NEW PROANGLE AQ - XL DESIGN

length = 280 cm - pack 5 pcs		H
ART.	finishing	10
ALUMINIUM		
	bright satin titanium	31290
	<i>euro/m</i>	
AQ	colour-coated white ST	31291
	<i>euro/m</i>	
individually packed		



For a single piece, see sales conditions on page 305







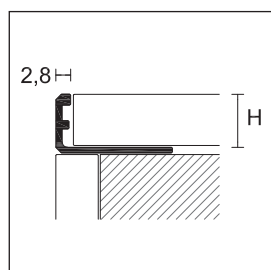







ZDK/8 chromium-plated brass

Proangle D XL Design ZD is a new profile in aluminium for the edging of the external corners of furnishing elements such as tables, kitchen or bathroom tops. It is characterized by a special shape that, thanks to the bevel, is rounded on both the exposed corners. ZD is available in bright satin titanium, white ST, black ST and in 9 new finishes: a range of colours including six original cement effects, two special metal tonalities and a white characterized by an extremely solid and full colour. Proangle XL Design is also available in chromium-plated brass (ZDK) for a result of great effect.



ZD/
ZDK/

NEW PROANGLE D - XL DESIGN

length = 280 cm - pack 5 pcs		H	
ART.	finishing	6	10
ALUMINIUM			
	bright satin titanium		88102 88105
	colour-coated white ST		88103 88106
	colour-coated black ST		88104 88107
	colour-coated concrete white		- 88108
	colour-coated concrete crete		- 88109
ZD/	colour-coated concrete graphite		- 88110
	colour-coated concrete smoke		- 88111
	colour-coated concrete mud		- 88112
	colour-coated concrete sand		- 88113
	colour-coated metal dark		- 88119
	colour-coated metal light		- 88120
	colour-coated solid white		- 88121
euro/m			

individually packed

NEW PROANGLE D - XL DESIGN

length = 280 cm - pack 5 pcs		H	
ART.	finishing	6	10
CHROMIUM-PLATED BRASS			
ZDK/	chromium plated		88100 88101
euro/m			

individually packed



ZD/10 colour-coated aluminium metal light

Complete the article code with the height H (for example ZD/ with H=10 becomes ZD/10).



Proangle Q XL Design ZQVN is an aluminium profile characterized by a square shape, that edges the external corners of ceramic coverings in a clear and elegant way. In addition to white ST and black ST, ZQVN is available in 9 new finishes: a range of colours including six original cement effects, two special metal tonalities and a white characterized by an extremely solid and full colour.

ZQVN/10 concrete white colour-coated aluminium

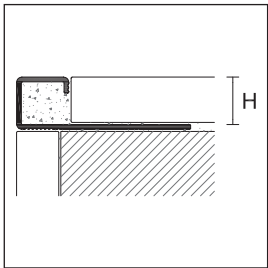

ZQVN/

NEW PROANGLE Q - XL DESIGN

length = 280 cm - pack 5 pcs

ART.	finishing		10
COLOUR-COATED ALUMINIUM			
	white ST		89110
	black ST		89111
	concrete white		89112
	concrete crete		89113
	concrete graphite		89114
ZQVN/	concrete smoke		89115
	concrete mud		89116
	concrete sand		89117
	metal dark		89118
	metal light		89119
	solid white		89130
euro/m			

individually packed

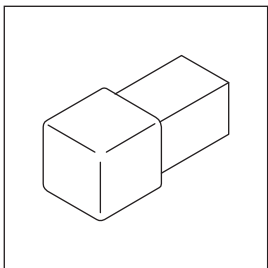

ZQVN/ /EI

NEW PROANGLE Q

pack 5 pcs

ART.	finishing		10
COLOUR-COATED ALUMINIUM			
	white ST		89340
	black ST		89350
	concrete white		89392
	concrete crete		89393
	concrete graphite		89394
ZQVN/ EI	concrete smoke		89395
	concrete mud		89396
	concrete sand		89397
	metal dark		89398
	metal light		89399
	solid white		89400
euro/pc			

no partial packaging

Complete the article code with the height H
(for example ZQVN/ with H=10 becomes ZQVN/10).

For a single piece, see sales conditions on page 305



LQL/2 metal light colour-coated aluminium

Prolight Prolist Q XL Design LQL/2 is a new decorative listello in aluminium with indirect LED light that, thanks to its particular section, creates a delicate and elegant line of light on the large-size ceramic slabs, thus embellishing the wall. This profile is available in white ST and in 9 new finishes: a range of colours including six original cement effects, two special metal tonalities and a white characterized by an extremely solid and full colour.

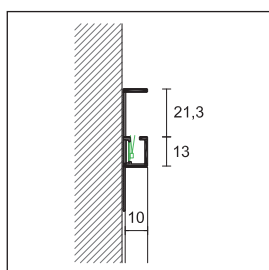

LQL/2

NEW PROLIGHT PROLIST Q - XL DESIGN

length = 280 cm - pack 5 pcs		H	
ART.	finishing	10	
COLOUR-COATED ALUMINIUM			
LQL/2	white ST	84010	
	concrete white	84011	
	concrete crete	84012	
	concrete graphite	84013	
	concrete smoke	84014	
	concrete mud	84015	
	concrete sand	84016	
	metal dark	84017	
	metal light	84018	
	solid white	84019	
	euro/m		

individually packed

NEW ELECTRICAL COMPONENTS AND ACCESSORIES FOR LIGHTING

ART.	description	
L5/NW/65 L	spool 5 m LED strips, lateral light, neutral colour 4000 °K, 9,6W/m IP65	84136
euro/m (euro/pack)		



SKL/2 concrete white colour-coated aluminium

Prolight Metal Line S XL Design SKL/2 is a new skirting board in aluminium with indirect LED light. Its special section allows to create an original play of light along the wall, thus adding value to the whole surface. In addition to the silver anodised and the white ST versions, SKL/2 is available in 9 new finishes: a range of colours including six original cement effects, two special metal tonalities and a white characterized by an extremely solid and full colour.

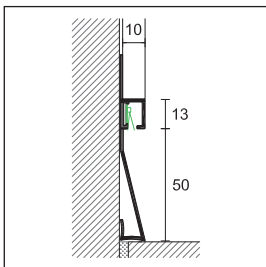

SKL/2

NEW PROLIGHT METAL LINE S - XL DESIGN

length = 280 cm - pack 5 pcs		H
ART.	finishing	10
ALUMINIUM		
SKL/2	silver anodised	78580
COLOUR-COATED ALUMINIUM		
	white ST	78581
	concrete white	78582
	concrete crete	78583
	concrete graphite	78584
	concrete smoke	78585
SKL/2	concrete mud	78586
	concrete sand	78587
	metal dark	78588
	metal light	78589
	solid white	78590
euro/m		

individually packed

NEW ELECTRICAL COMPONENTS AND ACCESSORIES FOR LIGHTING

ART.	description	
L5/NW/65 L	spool 5 m LED strips, lateral light, neutral colour 4000 °K, 9,6W/m IP65	84136
euro/m (euro/pack)		



Trend Color Stone

Colour-coated aluminium Trend Color Stone, modern finishes for external corner profiles with neutral but warm and soft colours which reproduce the heterogeneity of stone thanks to a rough texture pleasing to the touch.



ZQVN/10 stone



ZV/10 beige

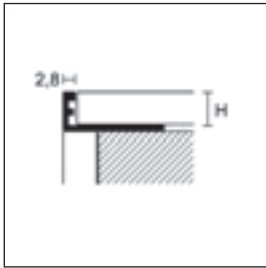

ZV/

PROANGLE - TREND COLOR STONE

length = 270 cm - pack 20 pcs		H		
ART.	finishing	8	10	11
COLOUR-COATED ALUMINIUM				
TREND COLOR STONE				
	dark brown	88446	88407	88417
	anthracite grey	88447	88398	88408
	ancient grey	88448	88400	88410
	grey	88449	88405	88415
ZV/	rust	88450	88399	88409
	bronze	88451	88406	88416
	stone	88452	88404	88414
	greige	88453	88403	88413
	sand	88454	88402	88412
	beige	88455	88401	88411
	white ST	88456	88428	88433
	black ST	88457	88429	88434
<i>euro/m</i>				

individually packed - Other heights with TREND COLOR finishes are available upon request, with a minimum of 540 meters.

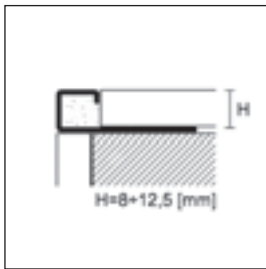

ZQVN/

PROANGLE Q - TREND COLOR STONE

length = 270 cm - pack 20 pcs		H			
ART.	finishing	8	10	11	12,5
COLOUR-COATED ALUMINIUM					
TREND COLOR STONE					
	dark brown	89360	89310	89311	89312
	anthracite grey	89093	89095	89106	89097
	ancient grey	89362	89220	89221	89222
	grey	89363	89290	89291	89292
ZQVN/	rust	89094	89096	89107	89098
	bronze	89365	89300	89301	89302
	stone	89366	89280	89281	89282
	greige	89367	89270	89271	89272
	sand	89368	89260	89261	89262
	beige	89369	89250	89251	89252
	white ST	89370	89320	89321	89322
	black ST	89371	89330	89331	89332
<i>euro/m</i>					

individually packed - Other heights with TREND COLOR finishes are available upon request, with a minimum of 540 meters.



PROANGLE Q - TREND COLOR STONE

pack 5 pcs*		H			
ART.	finishing	8	10	11	12,5
OUTSIDE / INSIDE CORNERS / END CAPS					
COLOUR-COATED ALUMINIUM					
TREND COLOR STONE					
	dark brown	89380	89303	89304	89305
	anthracite grey	89100	89102	89108	89104
	ancient grey	89382	89213	89214	89215
	grey	89383	89283	89284	89285
ZQVN/ /EI	rust	89101	89103	89109	89105
	bronze	89385	89293	89294	89295
	stone	89386	89273	89274	89275
	greige	89387	89263	89264	89265
	sand	89388	89253	89254	89255
	beige	89389	89243	89244	89245
	white ST	89390	89340	89341	89342
	black ST	89391	89350	89351	89352
<i>euro/pc</i>					

Complete the article code with H measure
(for example ZQVN/ for H=10 becomes ZQVN/10).

* available upon request pack of 1 pc in blister +
(for example ZQVN/10/EI code 89303 becomes 89303/B).

For a single piece, see sales conditions on page 305

no partial packaging



IPV/11 beige colour-coated aluminium

Protrim IPV is a profile characterized by minimal and elegant lines, for the edging of the 45-degrees external corners of the ceramic coverings. In 11 mm height, IPV is available in the 12 Trend Color Stone finishes: neutral but, at the same time, warm and soft tones that reproduce the heterogeneity of stone, thanks to a rough texture pleasing to the touch.

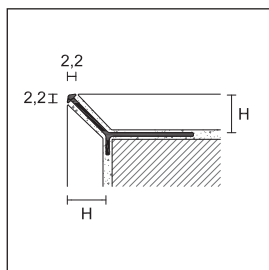

IPV/

NEW PROTRIM IP - TREND COLOR STONE

length = 270 cm - pack 20 pcs		H
ART.	finishing	11
COLOUR-COATED ALUMINIUM		
TREND COLOR STONE		
IPV/	dark brown	95182
	anthracite grey	95183
	ancient grey	95184
	grey	95186
	rust	95187
	bronze	95188
	stone	95189
	greige	95190
	sand	95191
	beige	95192
	white ST	95193
	black ST	95194
euro/m		

individually packed - Other heights with TREND COLOR finishes are available upon request, with a minimum of 540 meters.

Complete the article code with the height H (for example IPV/ with H=10 becomes IPV/10).

For a single piece, see sales conditions on page 305



90/6SF black ST colour-coated aluminium



89/4 white ST colour-coated aluminium

Metal Line 90 and 89 are available in the two new finishes Trend Color Stone, white ST and black ST: two matt and elegant colours that perfectly combine with the most modern ceramic coverings.

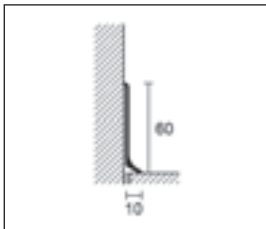

90/6SF

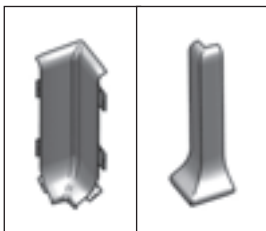

90/6MI inside corner
90/6ME outside corner

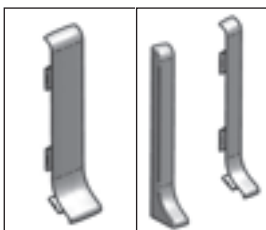

90/6MG junction
90/6MP end caps DX-SX

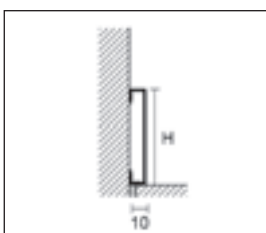

89/4

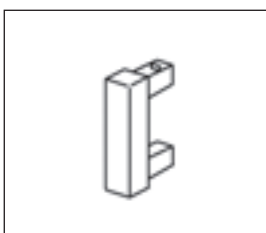

89/4EI

METAL LINE 90 - TREND COLOR STONE

length = 200 cm - pack 25 pcs		H cm
ART.	finishing	6
COLOUR-COATED ALUMINIUM		
TREND COLOR STONE		
90/6SF	white ST	78094
	black ST	78099
euro/m		

individually packed

ACCESSORIES METAL LINE 90 - TREND COLOR STONE

pack 4 pcs		H cm
ART.	finishing	6
COLOUR-COATED METAL		
TREND COLOR STONE		
inside corner		
90/6MI	white ST	78172
	black ST	78173
euro/pc		
TREND COLOR STONE		
outside corner		
90/6ME	white ST	78174
	black ST	78178
euro/pc		

no partial packaging

pack 4 pcs		H cm
ART.	finishing	6
COLOUR-COATED METAL		
TREND COLOR STONE		
junction		
90/6MG	white ST	78187
	black ST	78188
euro/pc		
TREND COLOR STONE		
end caps DX-SX		
90/6MP	white ST	78189
	black ST	78199
euro/couple		

no partial packaging

METAL LINE 89 - TREND COLOR STONE

length = 200 cm - pack 25 pcs		H cm
ART.	finishing	4
COLOUR-COATED ALUMINIUM		
TREND COLOR STONE		
89/4	white ST	78481
	black ST	78482
euro/m		

individually packed

ACCESSORIES METAL LINE 89 - TREND COLOR STONE

pack 4 pcs		H cm
ART.	finishing	4
COLOUR-COATED ALUMINIUM		
TREND COLOR STONE		
inside/outside corner - right/left end cap		
89/4EI	white ST	78507
	black ST	78508
euro/pc		

no partial packaging

Upon request and with a minimum order of 300 meters, the skirting board is available in other Trend Color Stone colours. For other colours, please contact our Sales Department.

For a single piece, see sales conditions on page 305



Trend Color Light

A line of profiles with new finishes which remember the nature places and the refined shades of gold. Thanks to a special coating, this line adds a value of lightness to the profiles.



ZQVN/10 zafferano



ZV/10 seppia

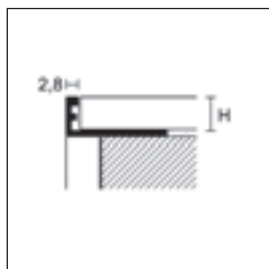

ZV/

PROANGLE - TREND COLOR LIGHT

length = 270 cm - pack 20 pcs		H
ART.	finishing	10
COLOUR-COATED ALUMINIUM		
TREND COLOR LIGHT		
	ardesia	88427
	bistro	88426
	mogano	88424
	seppia	88425
	oliva	88420
ZV/	kaki	88422
	pesca	88423
	zafferano	88421
	ecru	88419
	perla	88418
	<i>euro/m</i>	

individually packed - Other heights with TREND COLOR finishes are available upon request, with a minimum of 540 meters.

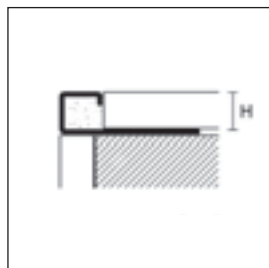

ZQVN/

PROANGLE Q - TREND COLOR LIGHT

length = 270 cm - pack 20 pcs		H	
ART.	finishing	10	12,5
COLOUR-COATED ALUMINIUM			
TREND COLOR LIGHT			
	ardesia	89129	89149
	bistro	89128	89148
	mogano	89126	89146
	seppia	89127	89147
	oliva	89122	89142
ZQVN/	kaki	89124	89144
	pesca	89125	89145
	zafferano	89123	89143
	ecru	89121	89141
	perla	89120	89140
	<i>euro/m</i>		

individually packed - Other heights with TREND COLOR finishes are available upon request, with a minimum of 540 meters.



ZQVN/ /EI

PROANGLE Q - TREND COLOR LIGHT

pack 5 pcs*		H	
ART.	finishing	10	12,5
INSIDE/OUTSIDE CORNERS/END CAPS			
COLOUR-COATED ALUMINIUM			
TREND COLOR LIGHT			
	ardesia	89159	89179
	bistro	89158	89178
	mogano	89156	89176
	seppia	89157	89177
	oliva	89152	89172
ZQVN/ /EI	kaki	89154	89174
	pesca	89155	89175
	zafferano	89153	89173
	ecru	89151	89171
	perla	89150	89170
	<i>euro/pc</i>		

Complete the article code with H measure (for example ZQVN/ for H=10 becomes ZQVN/10).

* available upon request pack of 1 pc in blister + (for example ZQVN/10/EI code 89159 becomes 89159/B).

For a single piece, see sales conditions on page 305

no partial packaging



X Design

Anodised aluminium X Design, an original finish in five tonalities for decorative listellos and profiles for the protection of external corners. These new colours allow many chromatic combinations and have been created for interior designers and architects by following the latest trends of modern design.

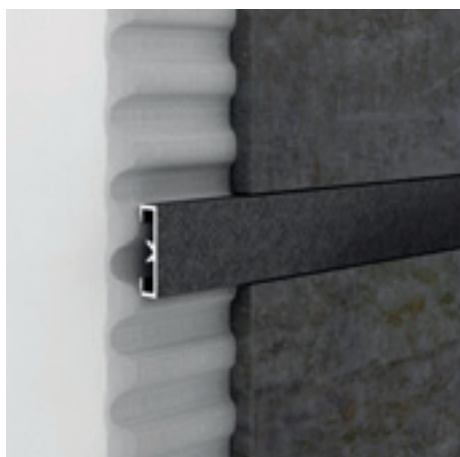

LDAD carbon



ZQAND brown

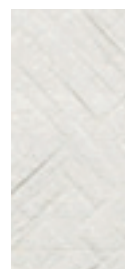

finishing
X DESIGN

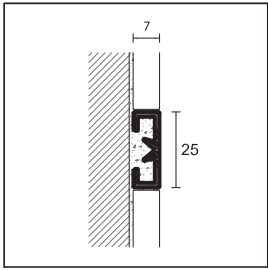

LDAD

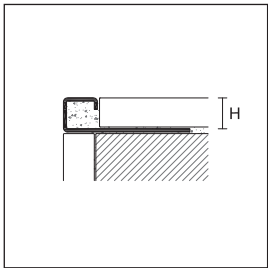

ZQAND/



Complete the article code with H measure
(for example ZQAND/ with H=8 becomes ZQAND/8)
For a single piece, see sales conditions on page 305

PROLIST - X DESIGN

length = 270 cm - pack 10 pcs

L x H

ART.	finishing		25x7
ANODISED ALUMINIUM			
	platinum		31320
	titanium		31322
LDAD	brown		31324
	dark brown		31326
	carbon		31328
<i>euro/m</i>			

individually packed

PROANGLE Q - X DESIGN

length = 270 cm - pack 20 pcs

H

ART.	finishing	8	10	12,5	
ANODISED ALUMINIUM					
	platinum		31110	31112	31114
	titanium		31120	31122	31124
ZQAND/	brown		31130	31132	31134
	dark brown		31140	31142	31144
	carbon		31150	31152	31154
<i>euro/m</i>					

individually packed

OUTSIDE / INSIDE CORNERS / END CAPS

PROANGLE Q - X DESIGN

pack 5 pcs

H

ART.	finishing	8	10	12,5	
ANODISED ALUMINIUM					
	platinum		31160	31162	31164
	titanium		31170	31172	31174
ZQAND/El	brown		31180	31182	31184
	dark brown		31190	31192	31194
	carbon		31200	31202	31204
<i>euro/pc</i>					

no partial packaging



platinum



titanium

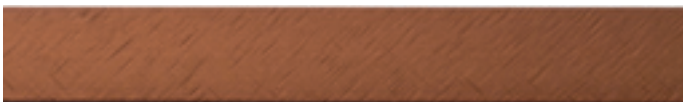

brown



dark brown



carbon



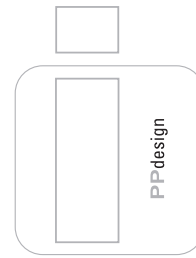

I Design

Anodised aluminium I Design. Modern colours and a nice satin finish for the new Metal Line skirting boards. The skirting board becomes a customization element integrated with the interior design.



89/6 platinum



89/6 carbon

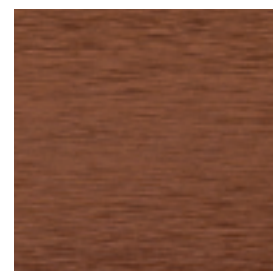

finishing
I DESIGN

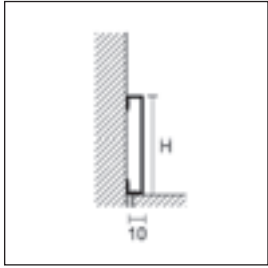

89/



METAL LINE - I DESIGN

length = 200 cm - pack 25 pcs

		H	
ART.	finishing	4	6
ANODISED ALUMINIUM			
	platinum	31400	31402
	titanium	31410	31412
89/	brown	31420	31422
	dark brown	31430	31432
	carbon	31440	31442
euro/m			

individually packed

OUTSIDE / INSIDE CORNERS / END CAPS

METAL LINE - I DESIGN

pack 2 pcs

		H	
ART.	finishing	4	6
ANODISED ALUMINIUM			
	platinum	31450	31452
	titanium	31460	31462
89/ EI	brown	31470	31472
	dark brown	31480	31482
	carbon	31490	31492
euro/pc			

no partial packaging

Complete the article code with H measure
(for example 89/ for H=4 becomes 89/4)

For a single piece, see sales conditions on page 305

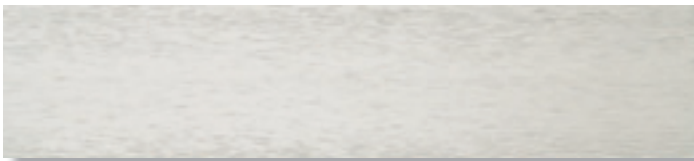

platinum

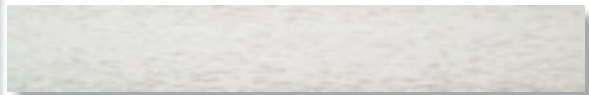

titanium



brown

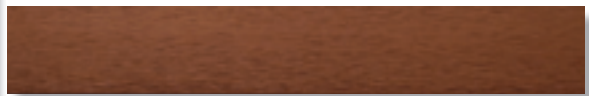

dark brown

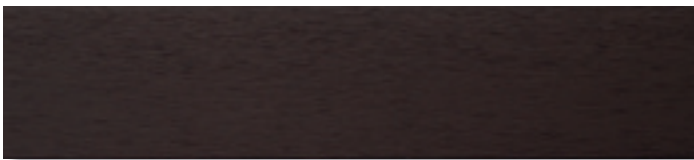

carbon





M Design

M Design is a range of finishing and connection profiles designed to define the ceramic coverings with sharp cuts and clean lines.

A line dedicated to those designers who love finishing the external corners of ceramic coverings and the connection between floors and coverings in a minimal way.



Proangle AX M Design is a profile in anodised or colour-coated aluminium, which finishes the vertical edge of the coverings, accentuating the discontinuity between the wall in an elegant way.

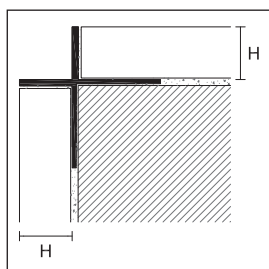

AX/2 silver anodised aluminium



AX/2

PROANGLE AX- M DESIGN

length = 270 cm - pack 10 pcs

		H			
ART.	finishing	NEW 6	NEW 10	12,5	
ALUMINIUM					
	silver anodised		13208	13209	13210
	<i>euro/m</i>				
AX/2	titanium anodised		13211	13213	13212
	colour-coated polished white RAL 9010		13215	13216	13214
	<i>euro/m</i>				

individually packed



AF/1 silver anodised aluminium

Metal Line AF M Design is an element in anodised or colour-coated aluminium which marks the connection between floors and coverings in same or different materials. The empty space creates an elegant shadow which clearly highlights the two different levels.

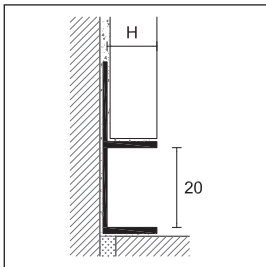

AF/1

METAL LINE AF - M DESIGN

length = 270 cm - pack 10 pcs

		H		
ART.	finishing	NEW 6	NEW 10	12,5
ALUMINIUM				
	silver anodised		13198	13199
	<i>euro/m</i>			13200
AF/1	titanium anodised		13201	13203
	colour-coated polished white RAL 9010		13196	13197
	<i>euro/m</i>			13204

individually packed



AL/2 silver anodised aluminium

Metal Line AL M Design is an element in anodised or colour-coated aluminium which connects floors and coverings in same or different materials. It defines the surfaces with a clean and rigorous sign.

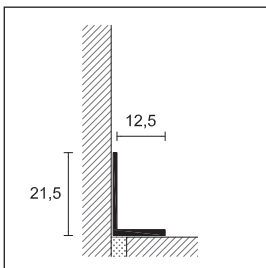

AL/2

METAL LINE AL - M DESIGN

length = 270 cm - pack 10 pcs

		H	
ART.	finishing	12,5	
ALUMINIUM			
	silver anodised		13220
	<i>euro/m</i>		
AL/2	titanium anodised		13222
	colour-coated polished white RAL 9010		13224
	<i>euro/m</i>		

individually packed



C Design

C Design is a line of profiles, embellished with crystals from Swarovski®. The combination of the chromium plated or gold plated profile and the crystal enhances the brightness of the lines and makes elegant any space.



DJKC/10 chromium-plated brass with crystals from Swarovski®



DJKC/10 chromium-plated brass with crystals from Swarovski®

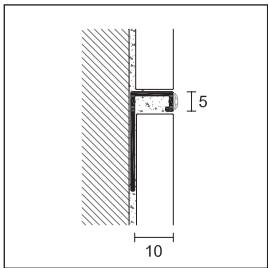

DJKC/10

PRODECOR - C DESIGN

length = 270 cm - pack 5 pcs		H
ART.	finishing	10
CHROMIUM-PLATED BRASS		
	chromium-plated + crystals from Swarovski®	13300
	<i>euro/m</i>	
DJKC/10	chromium-plated + crystals from Swarovski®	13302
	<i>euro/m</i>	

individually packed



UKC/10 chromium-plated brass with crystals from Swarovski®

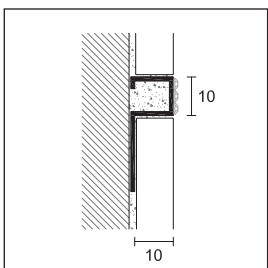

UKC/10

PROSTYLE - C DESIGN

length = 270 cm - pack 5 pcs		H
ART.	finishing	10
CHROMIUM-PLATED BRASS		
	chromium-plated + crystals from Swarovski®	13310
	<i>euro/m</i>	

individually packed

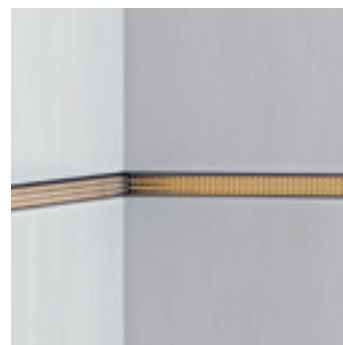

UKGC/10 24 kt gold plated brass + crystals from Swarovski®



DJKGC/10 24 kt gold plated brass + crystals from Swarovski®

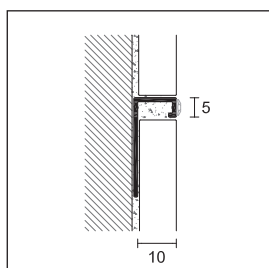

DJKGC/10

PRODECOR - C DESIGN

length = 270 cm - pack 5 pcs	H
ART. finishing	10
BRASS	
DJKGC/10 24 kt gold plated + crystals from Swarovski®	13402
<i>euro/m</i>	
individually packed	



UKGC/10 24 kt gold plated brass + crystals from Swarovski®

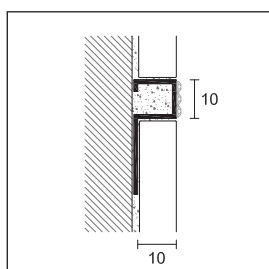

UKGC/10

PROSTYLE - C DESIGN

length = 270 cm - pack 5 pcs	H
ART. finishing	10
BRASS	
UKGC/10 24 kt gold plated + crystals from Swarovski®	13410
<i>euro/m</i>	
individually packed	

For a single piece, see sales conditions on page 305



DJKG/10 24 kt gold plated brass

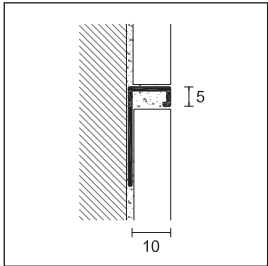

DJKG/10

PRODECOR - C DESIGN

length = 270 cm - pack 5 pcs		H
ART.	finishing	10
BRASS		
DJKG/10	24 kt gold plated	12902
<i>euro/m</i>		
individually packed		



UKG/10 24 kt gold plated brass

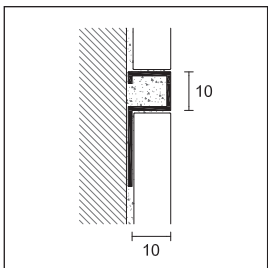

UKG/10

PROSTYLE - C DESIGN

length = 270 cm - pack 5 pcs		H
ART.	finishing	10
BRASS		
UKG/10	24 kt gold plated	12910
<i>euro/m</i>		
individually packed		

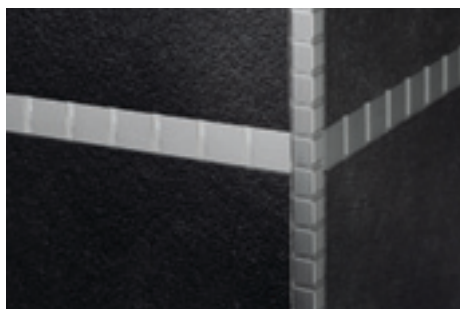

ZQACD/10 + LFCD/10 anodised aluminium

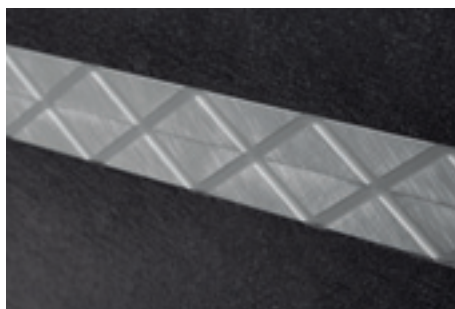

LFDBD/10 anodised aluminium

Omega Design is a range of listellos and profiles for external corners which stands out for its geometrical shapes applied in three different ways. Two or more listellos matched together allow to create further and creative geometrical shapes.

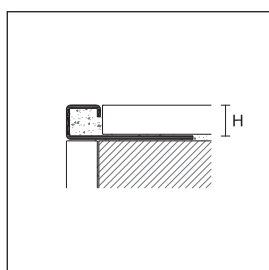

ZQACD/



PROANGLE Q - OMEGA DESIGN

length = 270 cm - pack 5 pcs

ART.	finishing	10	11	12,5
------	-----------	----	----	------

ALUMINIUM

ZQACD/	platinum anodised	31250	31252	31254
--------	-------------------	-------	-------	-------

individually packed

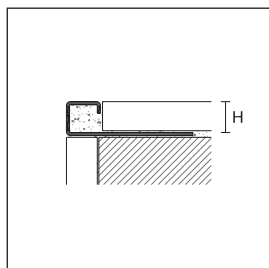

ZQAMD/



PROANGLE Q - OMEGA DESIGN

length = 270 cm - pack 5 pcs

ART.	finishing	10	11	12,5
------	-----------	----	----	------

ALUMINIUM

ZQAMD/	platinum anodised	31260	31262	31264
--------	-------------------	-------	-------	-------

individually packed

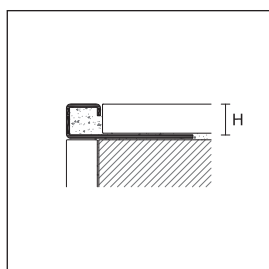

ZQADD/



PROANGLE Q - OMEGA DESIGN

length = 270 cm - pack 5 pcs

ART.	finishing	10	11	12,5
------	-----------	----	----	------

ALUMINIUM

ZQADD/	platinum anodised	31270	31272	31274
--------	-------------------	-------	-------	-------

individually packed

Complete the article code with H measure (for example ZQACD/ for H = 10 becomes ZQACD/10).

For a single piece, see sales conditions on page 305

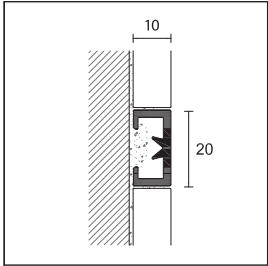

LFCD/10



PROLIST - OMEGA DESIGN

length = 270 cm - pack 5 pcs

L x H

ART. finishing

20 x 10

ALUMINIUM

LFCD platinum anodised
euro/m

31280

individually packed

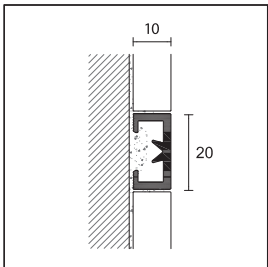

LFCBD/10



PROLIST - OMEGA DESIGN

length = 270 cm - pack 5 pcs

L x H

ART. finishing

20 x 10

ALUMINIUM

LFCBD platinum anodised
euro/m

31282

individually packed

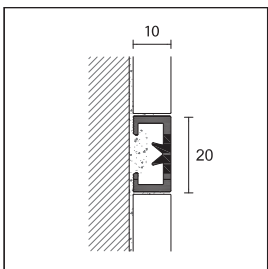

LFDD/10



PROLIST - OMEGA DESIGN

length = 270 cm - pack 5 pcs

L x H

ART. finishing

20 x 10

ALUMINIUM

LFDD platinum anodised
euro/m

31284

individually packed

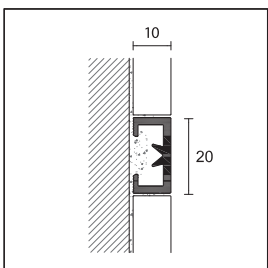

LFDBD/10



PROLIST - OMEGA DESIGN

length = 270 cm - pack 5 pcs

L x H

ART. finishing

20 x 10

ALUMINIUM

LFDBD platinum anodised
euro/m

31286

individually packed





prolight

Prolight is a line of light profiles with direct and indirect lighting. The integration of the LED technology with Profilpas profiles allows to customize every space. Available in warm, neutral or RGB light and provided with dimmer, they are easy to install and give the suitable light for each use, from the spaces for relaxation to work ones.





Prolist and Proangle Q

Prolist CLA is a profile in anodised aluminium with LED strip lighting system. Thanks to a diffuser, it gives a pleasant brightness to wall units, kitchens, bathrooms, wardrobes, stands etc.

Proangle ZQAL is a profile in natural aluminium for external corners.

Provided with a diffuser in different colours, thanks to a thin luminous line, it is perfect for increasing the safety in public and private spaces.



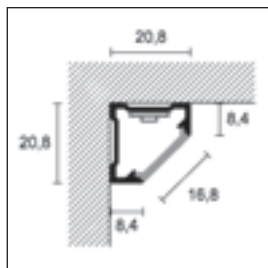

CLA/8
CLA/8A

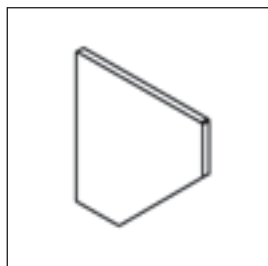

CLA/8P

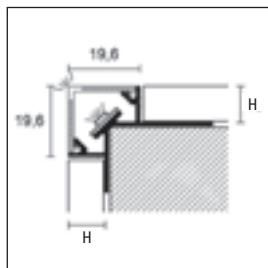

ZQAL/...B+ZQAL/10

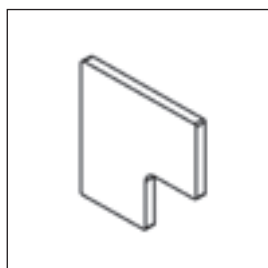

ZQAL/...P

PROLIGHT PROLIST

length = 270 cm - pack 10 pcs		H
ART.	finishing	8
ALUMINIUM		
CLA/8	silver anodised <i>euro/m</i>	84221
CLA/8A	silver anodised adhesive <i>euro/m</i>	84222

individually packed

END CAPS FOR CLA/8

pack 5 pcs		H
ART.	finishing	8
ALUMINIUM		
CLA/8P	silver anodised <i>euro/pc</i>	84223

no partial packaging

PROLIGHT PROANGLE Q

length = 270 cm - pack 10 pcs		H
ART.	finishing	10 13
ALUMINIUM		
ZQAL/10B	natural aluminium base <i>euro/m</i>	87226
ZQAL/13B	natural aluminium base <i>euro/m</i>	87227
OPALINE PVC		
ZQAL/10	white grey red yellow <i>euro/m</i>	87230 87231 87232 87233

Items available in different colours on demand minimum quantity 540 meters

END CAPS FOR ZQAL

pack 5 pcs		H
ART.	finishing	10 13
ALUMINIUM		
ZQAL/10P	natural aluminium <i>euro/pc</i>	87229
ZQAL/13P	natural aluminium <i>euro/pc</i>	87228

no partial packaging

For the best aesthetic result and the validity of the warranty, we suggest the exclusive use of our electrical components. See page 59

For a single piece, see sales conditions on page 305



Prolist

Prolight Prolist is a line of decorative LED-strip listellos for direct and indirect lighting. LLA/20, LLA/30 and TLA/10/C1 are perfect to frame mirrors and walls in order to customize and enhance spaces. Prolight Prolist are decorative elements of great charm, that find their ideal setting in environments such as bathrooms and kitchens.

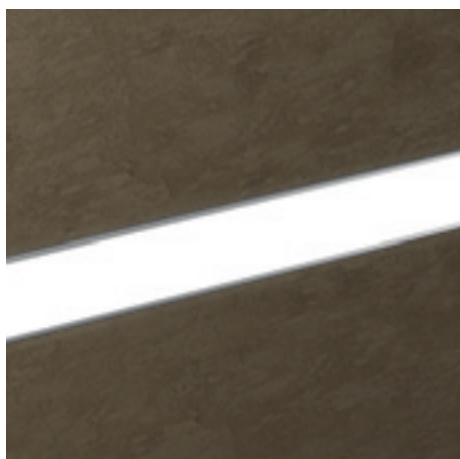

LLA/20 anodised aluminium

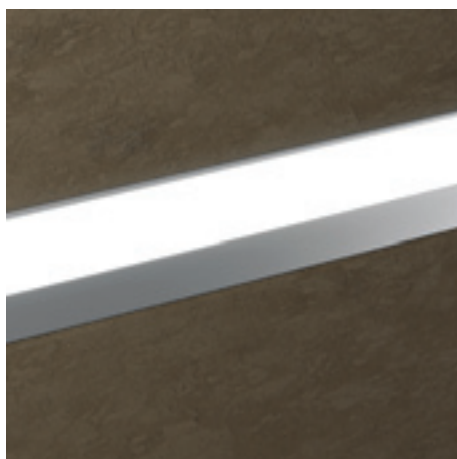

LLA/30 anodised aluminium

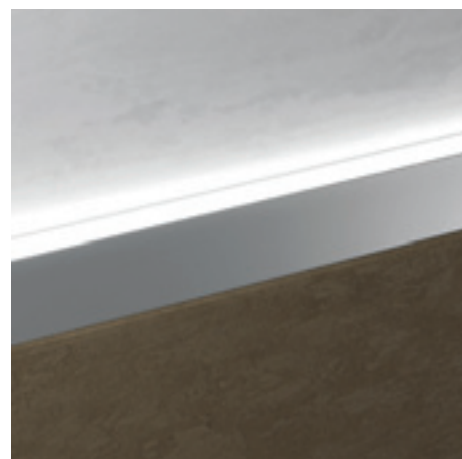

TLA/10/C1 anodised aluminium

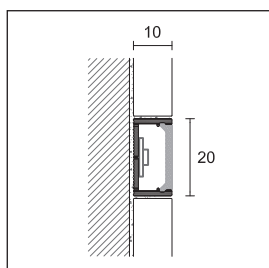

LLA/20

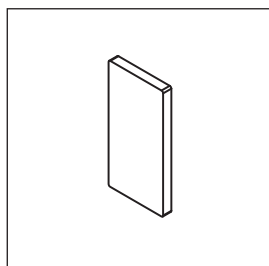

LLA/20P

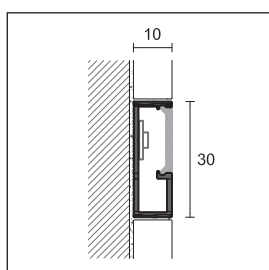

LLA/30

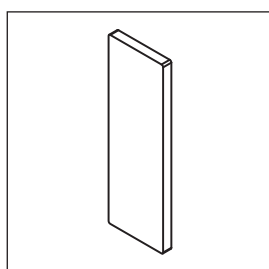

LLA/30P

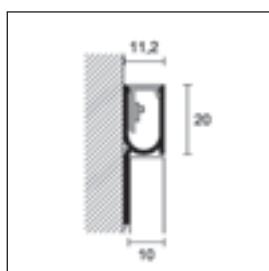

TLA/10/

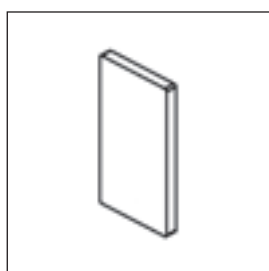

TLA/10P/

PROLIGHT PROLIST

length = 270 cm - pack 10 pcs **LxH**

ART. finishing **20x10**

ALUMINIUM

LLA/20	silver anodised		84070
	<i>euro/m</i>		

individually packed

END CAPS FOR LLA/20

pack 5 pcs

ART. finishing

ALUMINIUM

LLA/20P	silver anodised		84072
	<i>euro/pc</i>		

no partial packaging

PROLIGHT PROLIST

length = 270 cm - pack 10 pcs **LxH**

ART. finishing **30x10**

ALUMINIUM

LLA/30	silver anodised		84080
	<i>euro/m</i>		

LLB/30	bright polished silver		84081
	<i>euro/m</i>		

individually packed

END CAPS FOR LLA/30

pack 5 pcs

ART. finishing

ALUMINIUM

LLA/30P	silver anodised		84082
	<i>euro/pc</i>		

LLB/30P	bright polished silver		84083
	<i>euro/pc</i>		

no partial packaging

PROLIGHT PROLIST

length = 270 cm - pack 10 pcs **LxH**

ART. finishing **20x10**

ALUMINIUM

TLA/10/C1	silver anodised		84090
	<i>euro/m</i>		

TLB/10/C1	bright polished silver		84091
	<i>euro/m</i>		

individually packed

END CAPS FOR TLA/10/C1

pack 5 pcs

ART. finishing

ALUMINIUM

TLA/10P/C1	silver anodised		84092
	<i>euro/pc</i>		

TLB/10P/C1	bright polished silver		84093
	<i>euro/pc</i>		

no partial packaging

For the best aesthetic result and the validity of the warranty, we suggest the exclusive use of our electrical components. See page 59

For a single piece, see sales conditions on page 305



Prostep e Protect

Prostep and Protect are two lines of anodised aluminium stair nosing profiles. They are two solutions that highlight the design effect and increase the safety of the rooms. Prostep is suitable for private places to create new perspectives where light softly diffuses downwards; Prostep, thanks to the LED light that is horizontally oriented, is ideal for public spaces like clubs, cinemas, offices and boats, thus making these places comfortable and stylish.



G/8/SF silver anodised aluminium

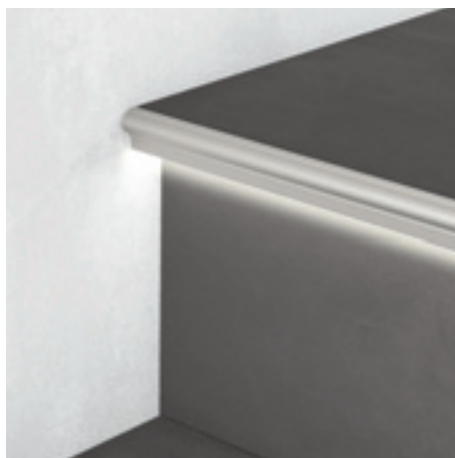

SGA/11L silver anodised aluminium



G/9/SF silver anodised aluminium

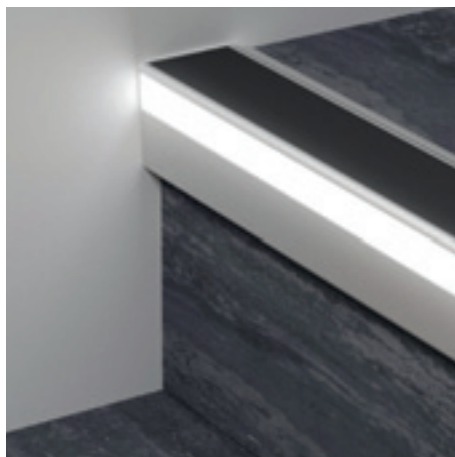

126/L/F silver anodised aluminium + GMR/44 black striped rubber

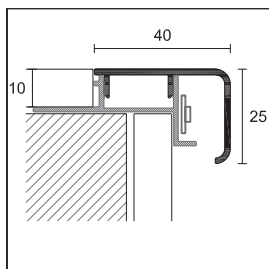

G/8/SF + G/8B/10

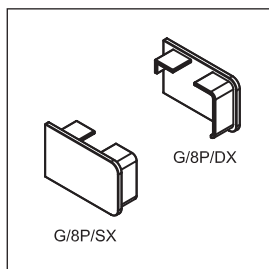

G/8P

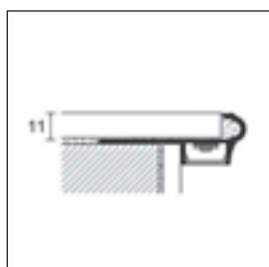

SGA/11L

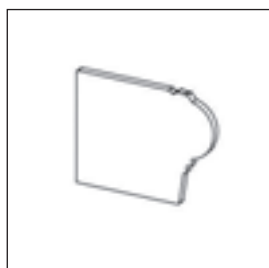

SGA/11P

PROLIGHT PROSTEP

length = 270 cm - pack 10 pcs

ART. finishing

ALUMINIUM

G/8/SF	silver anodised		84210
	<i>euro/m</i>		

individually packed

BASES FOR PROFILES G/8/SF

length = 270 cm - pack 10 pcs

ART. finishing

ALUMINIUM

G/8B/10	natural aluminium		84215
	<i>euro/m</i>		

END CAPS FOR PROFILE G/8/SF

pack 5 pcs

ART. finishing

METAL

G/8P/DX	silver		84206
	<i>euro/pc</i>		

G/8P/SX	silver		84204
	<i>euro/pc</i>		

no partial packaging

PROLIGHT PROSTEP

length = 270 cm - pack 10 pcs

H mm

ART. finishing

11

ALUMINIUM

SGA/11L	silver anodised		94969
	<i>euro/m</i>		

individually packed

END CAPS FOR PROFILE SGA/11L

pack 5 pcs

H mm

ART. finishing

11

ALUMINIUM

SGA/11P	silver anodised		94964
	<i>euro/pc</i>		

no partial packaging

For the best aesthetic result and the validity of the warranty, we suggest the exclusive use of our electrical components. See page 59

For a single piece, see sales conditions on page 305

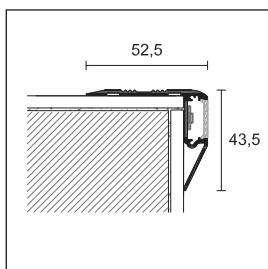

G/9/F

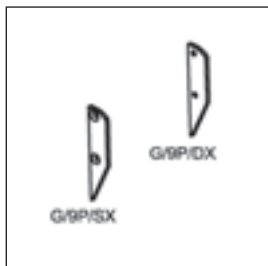

G/9P

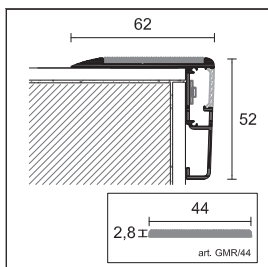

126/L/F



126/LP

PROLIGHT PROTECT

length = 270 cm - pack 10 pcs

ART. finishing

ALUMINIUM

G/9/F	silver anodised		84050
	<i>euro/m</i>		

individually packed

END CAPS FOR PROFILE G/9/F

pack 5 pcs

ART. finishing

ALUMINIUM

G/9P/DX	silver anodised		84052
	<i>euro/pc</i>		

G/9P/SX	silver anodised		84053
	<i>euro/pc</i>		

no partial packaging

PROLIGHT PROTECT

length = 270 cm - conf. 6 pz

ART. finishing

ALUMINIUM

126/L/F	silver anodised		84060
	<i>euro/m</i>		

individually packed

GROOVED RUBBER

length = 1700 cm - conf. 1 rotolo

ART.

GMR/44	black		75706
	<i>euro/m</i>		

END CAPS FOR 126/L/F

pack 5 pcs

ART. finishing

ALUMINIUM

126/LP/DX	silver anodised		84062
	<i>euro/pc</i>		

126/LP/SX	silver anodised		84063
	<i>euro/pc</i>		

no partial packaging



G/9/F silver anodised aluminium

For the best aesthetic result and the validity of the warranty, we suggest the exclusive use of our electrical components. See page 59

For a single piece, see sales conditions on page 305



88/16L/A silver anodised aluminium

Metal Line 88/16L/A is a skirting board flush with the wall and with LED lighting system. The light is distributed along the whole length of the profile and passes through a visible gap. There is the possibility to insert the optional dimmer to adjust the light intensity of the skirting board and create both an elegant decoration and a night courtesy light.

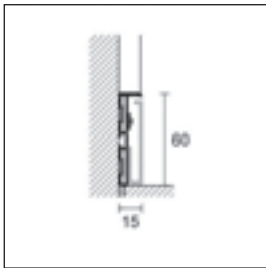

87/6 + 88/16L

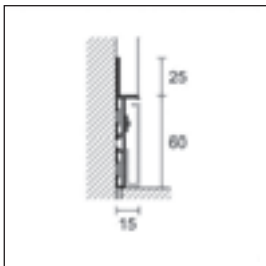

88/6 + 88/16L

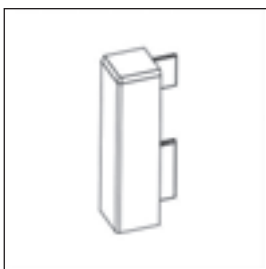

88/6E

METAL LINE 87 - 88

length = 200 cm - pack 20 pcs H cm

ART. finishing 6

ALUMINIUM

87/6	natural aluminium (drilled)		78338
	<i>euro/m</i>		

88/6	natural aluminium (drilled)		78310
	<i>euro/m</i>		

individually packed

ALUMINIUM INSERT FOR LED LIGHT

88/16L/A	silver anodised		78559
	colour-coated matt white RAL 9010		78560
	<i>euro/m</i>		

adhesive - individually packed

OUTSIDE CORNER IN METAL

pack 4 pcs H cm

ART. finishing 6

88/6E	silver		78561
	colour-coated matt white RAL 9010		78562
	<i>euro/pc</i>		

no partial packaging



88/6 + 88/16L/A silver anodised aluminium

For the best aesthetic result and the validity of the warranty, we suggest the exclusive use of our electrical components. See page 59

For a single piece, see sales conditions on page 305



Metal Line 89 is a skirting board in anodised aluminium with LED-strip lighting system. The light is distributed along the entire length of the profile through a diffuser element. It is possible to insert the dimmer in order to adjust the luminous intensity of the skirting board to decorate and light up the room.

89/6L silver anodised aluminium

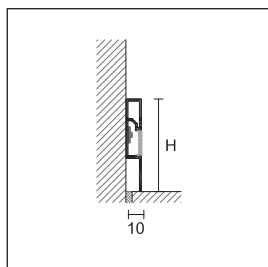

89/6L

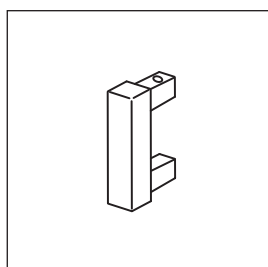

89/6EI

PROLIGHT METAL LINE 89

length = 200 cm - pack 25 pcs		H cm
ART.	finishing	6
ALUMINIUM		
89/6L	silver anodised 	86000
euro/m		

individually packed

INSIDE/OUTSIDE CORNER - RIGHT/LEFT END CAP

pack 4 pcs		H cm
ART.	finishing	6
ALUMINIUM		
89/6EI	silver anodised 	78506
euro/pc		

no partial packaging

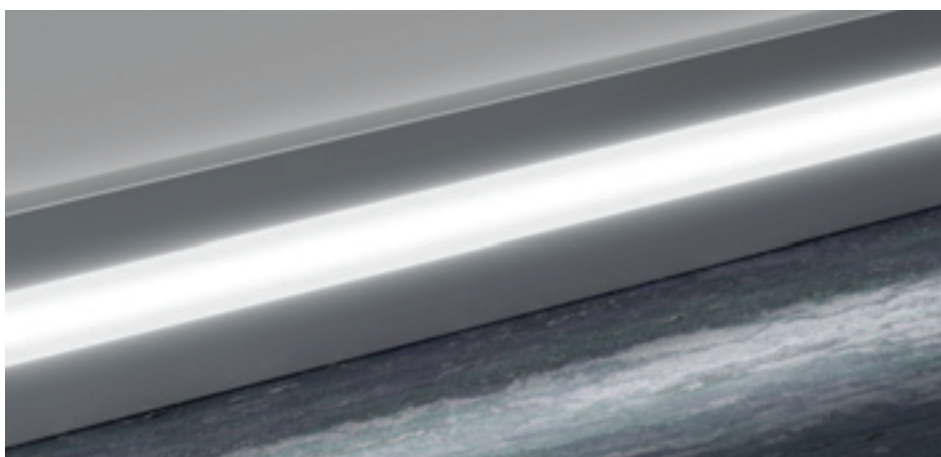

89/6L silver anodised aluminium

For the best aesthetic result and the validity of the warranty, we suggest the exclusive use of our electrical components. See page 59

For a single piece, see sales conditions on page 305



105/7 silver anodised aluminium + 105/CB + 105/PL silver anodised aluminium

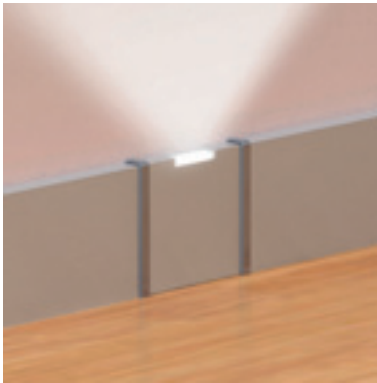

ICEBERG is a skirting board in anodised aluminium designed by Profilpas, characterized by special vertical light points that are real design elements. The light point includes a lens and a heat sink and can be connected to the dimmer and to the sensor (optional) to adjust the light intensity and the automatic switching on. The light points enhance the perimeters and create beautiful special effects in the environments.



105/PL silver anodised aluminium

ICEBERG

pack 10 pcs		H cm
ART.	finishing	length

ALUMINIUM				
105/7	silver anodised		200 cm	78900
	silver anodised		400 cm	78910

euro/m

individually packed

FIXING BASE

pack 10 pcs		H cm
ART.	length	7

CO-EXTRUDED PVC				
105/CB	white		200 cm	78920

euro/m

no partial packaging

LIGHT POINT

pack 1 pc		H cm
ART.	finishing	7

ALUMINIUM				
105/PL	silver anodised			78930

euro/pc

individually packed

INSIDE CORNER

pack 4 pcs		H cm
ART.	finishing	7

METAL				
105/7I	silver			78932

euro/pc

no partial packaging

OUTSIDE CORNER

pack 4 pcs		H cm
ART.	finishing	7



METAL				
105/7E	silver			78934

euro/pc

no partial packaging

JUNCTION

pack 4 pcs		H cm
ART.	finishing	7

METAL				
	silver			78936
105/7G	black			78935
	chromium plated			78937

euro/pc

no partial packaging

END CAPS RH-LH

4 couples pack		H cm
ART.	finishing	7

METAL				
105/7P	silver			78938

euro/couple

no partial packaging

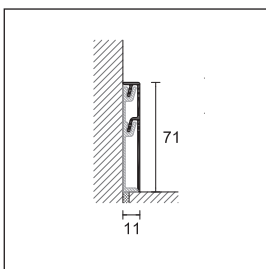

105/7
105/CB

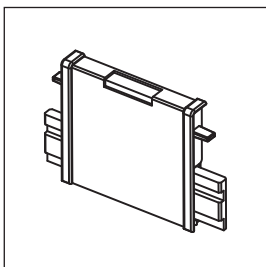

105/PL

For the best aesthetic result and the validity of the warranty, we suggest the exclusive use of our electrical components. See page 59

For a single piece, see sales conditions on page 305



spool 6 m strip LED

Electrical components and accessories for Prolight profiles. Each element has to be chosen depending on the established length of the light profiles. It is necessary to calculate the power consumption in W/m for choosing one or more power supplies to be combined with the dimmer and the controller.



ELECTRICAL COMPONENTS AND ACCESSORIES FOR LIGHTING

ART.	description	
L5/NW/33	spool 5 m LED strip colour neutral white 4000° K - 9,6W/m - IP33 euro/m (euro/pack)	84105
L5/WW/33	spool 5 m LED strip colour warm white 3000° K - 9,6W/m - IP33 euro/m (euro/pack)	84115
L5/NW/67	spool 5 m LED strip colour neutral white 4000° K - 9,6W/m - IP67 euro/m (euro/pack)	84125
L5/WW/67	spool 5 m LED strip colour warm white 3000° K - 9,6W/m - IP67 euro/m (euro/pack)	84135
L5/RGB/67	spool 5 m RGB LED strip - 14,4 W/m - IP67 euro/m (euro/pack)	84140
AL/60/24	power supply IP67 - PFC active - 24Vdc/60W euro/pc	84150
AL/90/24	power supply IP67 - PFC active - 24Vdc/90W euro/pc	84152
AL/120/24	power supply IP67 - PFC active - 24Vdc/120W euro/pc	84154
AL/150/24	power supply IP67 - PFC active - 24Vdc/150W euro/pc	84156
DIMM/02	dimmer/driver 24V/10 Amp - dim. mm 57x44x19 h. for white LED light euro/pc	84187
TEL/04	4- channel radio frequency remote control euro/pc	84182
RIC/01	4- remote control receiver radio frequency euro/pc	84184
TEL/RGB/04	4 channel radiofrequency remote control 433,92MHz for RGB LED - diam. 80x13 h euro/pc	84183
RIC/RGB/M	master control unit with dimmer functiona/wireless for RGB LED - diam. 174x46x35 h euro/pc	84185
RIC/RGB/S	slave control unit whit dimmer function for RGB LED (maximum 4 slave for each master) euro/pc	84186
CE/5/20	electrical cable sect. 0,5 mm ² - pack 20 ml euro/m	84420
CE/10/20	electrical cable sect. 1 mm ² - pack 20 ml euro/m	84422
CE/10/100	electrical cable sect. 1 mm ² - pack 100 ml euro/m	84424
CE/RGB/20	electrical cable for RGB LED section 3x0,5 mm ² + 1x1 mm ² - pack 20 m euro/m	84426
IR/C01	rapid fit connector for strip LED white light - pack 10 pcs euro/pc	84411
IR/W3	rapid fit connector 3 cables - pack 10 pcs euro/pc	84410
IR/C02	rapid fit connector RGB LED strip - pack 10 pcs euro/pc	84415
IR/C03	rapid fit double connector RGB LED strip - pack 10 pcs euro/pc	84416

For a single piece, see sales conditions on page 305

HOW TO ORDER THE ELECTRICAL COMPONENTS

LED (white light)

Measure how many meters of LED strip have to be positioned on our profiles. A spool is 5 meters long. Spools have 120 LED every meter. The voltage is 24 volt. The consumption is 9,6 watts every meter. To determine the consumption, length must be multiplied by 9,6 watts.

Example: calculation of the watts consumption = 7,4m x 9,6W = 71 total watts

Choose the colour of the light. LED strips are available in neutral white light (4000 °K) or warm white light (3000 °K).
Choose the degree of protection: IP33 for inside and dry spaces, IP67 for outside or moist spaces.

POWER SUPPLIES

Choose the suitable power supply on the basis of the total watts and so as not to exceed 90% of the maximum power.

Example: 71W : 90 x 100 = 79W - use a power supply of 90W

	ART.		
from 5 cm to 5,5 m	60W	AL/60/24	84150
from 5,6 m to 8,4 m	90W	AL/90/24	84152
from 8,5 m to 11,2 m	120W	AL/120/24	84154
from 11,3 m to 14 m	150W	AL/150/24	84156

We recommend to power the LED strips every 3 meters in order to avoid differences in brightness and the overheating of the LED in the initial part of them. A cable with 1 mm² section has a maximum range of about 4 Amp and a voltage drop of 1 Volt every 10 meters. For special installations, please contact our Technical Department.

DIMMER (optional)

The dimmer/fader/driver has the function to adjust the light intensity of LED light, it supports maximum 10 Amp to an equal extent of 25 linear meters of our LED strip. It must be placed between the power supply and the LED strip and connected to a switch (not supplied) and/or to the receiver of the remote control (optional).

In case of more lines with simultaneous turning on, the first dimmer is connected in Sync mode and it will switch on the consecutive dimmers.

Example: to connect 3 lines with simultaneous turning on, you need to use 3 dimmers.

REMOTE CONTROL + RECEIVER (optional)

The remote control is a radiofrequency and can control up to 4 channels; it is used to turn on/off the LED.

The receiver must be installed between the power supply and the LED strip or connected to the dimmer if present.

If there is also the dimmer, the remote control can adjust the LED light intensity.

ELECTRICAL CABLES

The cables are necessary to connect the power supply to the LED strips where needed.

A cable with 1 mm² section has a maximum range of about 4 amps and a voltage drop of 1 volt every 10 meters.

CONNECTORS

Art. IR/C01 connects the LED strips to the line of power supply.
Art. IR/W3 connects maximum 3 cables among them.

LED RGB (coloured light)

Measure how many meters of LED strip have to be positioned on our profiles. A spool is 5 meters long. Spools can be cut every 10 cm. The voltage is 24 volt. The consumption is 14,4 watts every meter. To determine the consumption, length must be multiplied by 14,4 watts.

Example: calculation of the watts consumption = 7,4m x 14,4W = 106,6 total watts

RGB LED strips are available in degree of protection IP67, are covered with silicone sheath and are provided with adhesive for the fastening in inside or outside spaces.

POWER SUPPLIES

Choose the suitable power supply on the basis of the total watts and so as not to exceed 90% of the maximum power.

Example: 106,60W : 90 x 100 = 118W - use a power supply of 120W

	ART.		
from 10 cm to 3,7 m	60W	AL/60/24	84150
from 3,8 m to 5,5 m	90W	AL/90/24	84152
from 5,6 m to 7,5 m	120W	AL/120/24	84154
from 7,6 m to 9,3 m	150W	AL/150/24	84156

We recommend to power the LED strips every 3 meters in order to avoid differences in brightness and the overheating of the LEDs in the initial part. A cable with 1 mm² section has a maximum range of about 4 amp and a voltage drop of 1 volt every 10 meters. For length over 9,3 meters, see SLAVE paragraph. For special installations, please contact our Technical Department.

REMOTE CONTROL

The remote control is a radiofrequency and can control up to 4 channels; it is used to turn on/off the LED, adjust light intensity and choose the colour or the sequence of LEDs.

MASTER CONTROL UNIT

Connected with the remote control, it is used to turn on/turn off/adjust light intensity and to choose the colour or the sequence of LEDs.

It must be connected between the power supply and the LED strip.

SLAVE CONTROL UNIT

Every time that the system needs more lines controlled by just one unit, there is the need to add 1 slave for every added line.

Example: to connect 3 lines with simultaneous lighting, you need to use 1 master control unit and 2 slave control units.

The slave control unit must be connected to the master control unit with RJ11 6-poles cable (not supplied).

ELECTRICAL CABLES

The cable has 4 poles, 3 of them have a 0,5 mm² section (for the three colours), one of them has a 1 mm² section (for the negative pole).

CONNECTORS

Art. IR/C02 connects the LED strips with coloured light to the line of power supply, length of 15 cm.
Art. IR/C03 connects LED strips to LED strips with coloured light, length of 15 cm.

We recommend to assign the assembly of the electrical components to qualified staff.





listellos and decorative profiles

The line of decorative listellos provides a wide variety of finishes, suitable for endless combinations and multiple aesthetic architectural tastes, from classic to contemporary; they are applicable to all environments with ceramic tiles from kitchen to bathroom, from living rooms to large commercial spaces.





LDAG/20 bright scratched silver aluminium

Prolist is a range of decorative listellos designed to create stylish and eye-catching aesthetic effects of wall tiles. They are available in different materials and colors, and can be coordinated to the profiles of the ranges PROTRIM and Proangle to obtain elegant and sophisticated combinations.

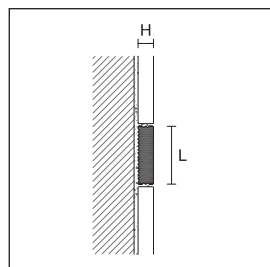

LJ - LK

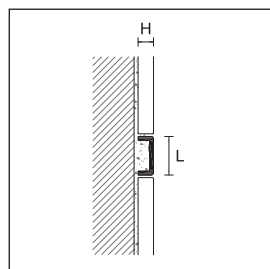

LI - LIS

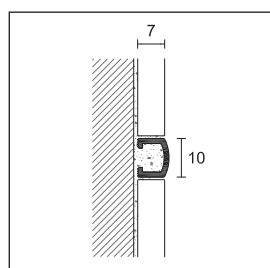

LB/B/10

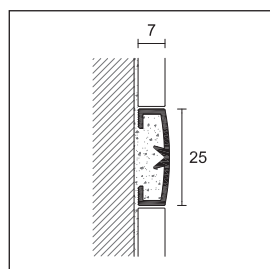

LB/A
LB/B/25

Complete the article code with L measure (for example LKA/ for L=10 becomes LKA/10)

Stainless steel listellos: different measures on demand - minimum 108 meters

* Out of production items, available till end of stock

For a single piece, see sales conditions on page 305

PROLIST

length = 270 cm - pack 20 pcs

ART.	finishing		L x H			
			10x3	10x4	15x4	20x4
ALUMINIUM						
LJA	silver anodised		93453	-	-	-
LKA/	silver anodised		-	93450	93451	93452
	<i>euro/m</i>					
LKB	bright polished silver		-	93455	-	-
	<i>euro/m</i>					
LKTM	bright satin titanium		-	93456 *	-	-
LKRS	bright satin copper		-	93457 *	-	-
	<i>euro/m</i>					

pack 10 pcs (for LI and LIS profiles)

STAINLESS STEEL

LI	polished stainless steel AISI 304 DIN 1.4301		-	93454	-	-
	<i>euro/m</i>					
LIS	satin stainless steel AISI 304 DIN 1.4301		-	93458	-	-
	<i>euro/m</i>					

individually packed

PROLIST

length = 270 cm - pack 20 pcs

ART.	finishing		L x H	
			10x7	25x7
ALUMINIUM				
LB/A	silver anodised		-	93270
	<i>euro/m</i>			
LB/B/	bright polished silver		93252	93272
	bright polished gold		93253	93273
	<i>euro/m</i>			

individually packed



LI/10 polished stainless steel AISI 304 DIN 1.4301



LB/B/10 bright polished aluminium silver



LDS/20 bright satin silver aluminium

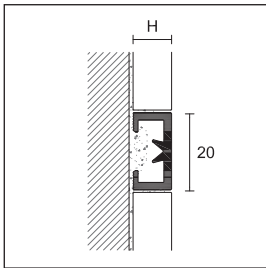
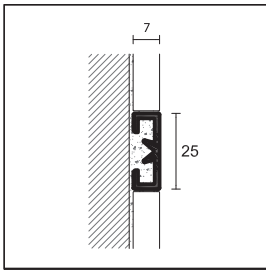

LFAG/

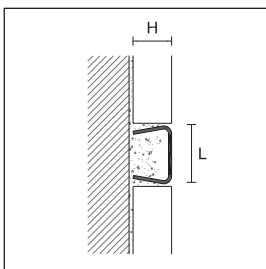

LA/I/
LA/IS/

April 2020: LDB/15 available in another new titanium finish.

Complete the article code LFAG/ with H measure
(for example LFAG/ for H=10 becomes LFAG/10)

Complete the article code with L measure
(for example LDA/ for L=10 becomes LDA/10)

Stainless steel listellos:
different measures on demand - minimum 108 meters

For a single piece, see sales conditions on page 305

PROLIST

length = 270 cm - pack 20 pcs

L x H

ART.	finishing	10x7	15x7	20x7	25x7
------	-----------	------	------	------	------

ALUMINIUM

LDA/	silver anodised		93255	93215	93220	93256
<i>euro/m</i>						
LDB/	bright polished silver		93258	93219	93224	93259
LDT/	bright polished titanium		93257	93218	93223	93268
<i>euro/m</i>						
LDS/	bright satin silver		93240	93216	93221	93244
	bright satin gold		93241	93217	93222	93245
LDTM/	bright satin titanium		93266	93211	93225	93246
LDRS/	bright satin copper		93242	93267	93229	93269
<i>euro/m</i>						
LDAG/	bright scratched silver		93263	93214	93228	93243
<i>euro/m</i>						

individually packed

PROLIST

length = 270 cm - pack 20 pcs

L x H

ART.	finishing	20x7
------	-----------	------

COLOUR-COATED ALUMINIUM

NEW LDV/	white ST		93207
	black ST		93209
<i>euro/m</i>			

individually packed

PROLIST

length = 270 cm - pack 20 pcs

L x H

ART.	finishing	20x10	20x15
------	-----------	-------	-------

ALUMINIUM

LFAG/	silver scratched		93473	93483
<i>euro/m</i>				

individually packed

PROLIST

length = 270 cm - pack 10 pcs

L x H

ART.	finishing	10x10	15x10	25x10
------	-----------	-------	-------	-------

STAINLESS STEEL

LA/I/	polished stainless steel AISI 304 DIN 1.4301		93283	93284	93285
<i>euro/m</i>					
LA/IS/	satin stainless steel AISI 304 DIN 1.4301		93296	93297	93298
<i>euro/m</i>					

individually packed



LDB/20 bright polished silver aluminium





external corners profiles

A line dedicated to the protection and finishing of outside corners of the wall tiles. Profiles are suitable for any type of environment for the variety of finishes available, matching perfectly with all types of ceramics and giving character to the compositions and linearity.





RA/10 silver anodised aluminium

PROTRIM is a line of profiles specially designed to seal and protect the outside corners of the ceramic, thus avoiding the unsightly and fragile cut at 45 °; the rounded shape also acts as finishing symmetric and accident prevention of the angle of the coating. PROTRIM is also suitable for applications of closure and protection of floors, stairs, and platforms. RVH/, used as sealing and protection profile for external corners of ceramic coverings, is provided with the certified antibacterial technology (according to the strict test internationally recognised JIS Z 2801:2000) which allows to reduce the presence of the most dangerous bacteria up until 99%, thus assuring the best hygienic level over time.

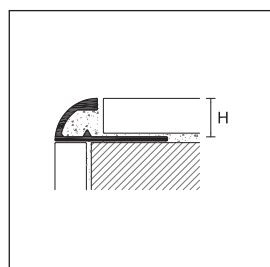
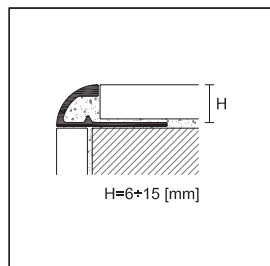
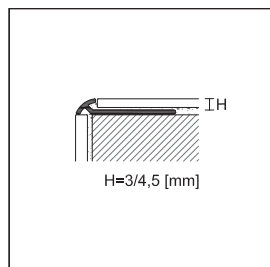

RV/

Complete the article code with H measure (for example RA/ for H=8 becomes RA/8)

Items RV/ available in different colours on demand - minimum quantity 540 meters for colour

* Out of production items, available till end of stock

For a single piece, see sales conditions on page 305

PROTRIM

length = 270 cm - pack 20 pcs

ART.	finishing	H								
		3	4,5	6	8	10	11	12,5	15	
ALUMINIUM										
RA/	silver anodised		92055	92056	92070	92072	92074	92060	92076	92078
	gold anodised		92025	92026	92040	92042	92044	-	92046	-
	titanium anodised		92085	92086	92087	92090	92094	-	92096	-
<i>euro/m</i>										
RB/	bright polished silver		92315	92316	92310	92312	92314	92061	92318	-
<i>euro/m</i>										
RB/	bright polished gold		92325	92326	92340	92342	92344	-	92348	-
RT/	bright polished titanium		92015	92016	92018	92020	92022	-	92023	-
<i>euro/m</i>										
RAS/	bright satin silver		92050	92051	92071	92073	92075	92062	92077	-
	bright satin gold		-	-	92041	92043	92045	-	92047	-
RTM/	bright satin titanium		92053	92057	92064	92066	92068	-	92079	-
<i>euro/m</i>										

individually packed

PROTRIM

length = 270 cm - pack 20 pcs

ART.	finishing	H					
		6	8	10	11	12,5	
COLOUR-COATED ALUMINIUM							
RV/	matt white RAL 9003		-	92107	92108	92109	92110
	white RAL 9003		92100	92102	92104	92111	92106
	cream white RAL 9001		92130 *	92132 *	92134 *	-	-
	pearl white RAL 1013		92160 *	92162 *	92164 *	-	-
	beige grey RAL 1019		92190 *	92192 *	92194 *	-	-
	stone grey RAL 7030		92220 *	92222 *	92224 *	-	-
	light grey RAL 7035		92250 *	92252 *	92254 *	-	-
	red RAL 3002		92280 *	92282 *	92284 *	-	-
	black RAL 9005		92400 *	92402 *	92404 *	-	-
	<i>euro/m</i>						

ANTIBACTERIAL COLOUR-COATED ALUMINIUM

RVH/	white RAL 9003		-	92112	92114	92116
<i>euro/m</i>						

individually packed



RA/10+TA/10+TIA/10 silver anodised aluminium

PROTRIM

packaging of 5 pcs*

		H					H						
		OUTSIDE CORNER					INSIDE CORNER						
ART.	finishing	6	8	10	11	12,5	ART.	6	8	10	11	12,5	
ALUMINIUM													
TA/	silver anodised		92606	92608	92610	92600	92612		92570	92571	92572	92603	92573
	gold anodised		92614	92616	92618	-	92619	TIA/	92575	92576	92577	-	92578
	titanium anodised		92564	92566	92568	-	92569		92554	92555	92556	-	92558
<i>euro/pc</i>													
TB/	bright polished silver		92690	92692	92694	92601	92696	TIB/	92580	92581	92582	92604	92583
	bright polished gold		92700	92702	92704	-	92706		92585	92586	92587	-	92588
TAT/	bright polished titanium		92724	92726	92728	-	92729	TIAT/	92730	92732	92734	-	92736
<i>euro/pc</i>													
TAS/	bright satin silver		92710	92711	92712	92602	92713	TIAS/	92550	92551	92552	92605	92553
	bright satin gold		92720	92721	92722	-	92723		92560	92561	92562	-	92563
TATM/	bright satin titanium		92714	92716	92718	-	92773		-	-	-	-	
<i>euro/pc</i>													
COLOUR-COATED ALUMINIUM*													
TV/	matt white RAL 9003		-	92636	92637	92638	92639	TIV/	-	92646	92647	92648	92649
	white RAL 9003		92620	92622	92624	92628	92626		92621	92623	92625	92629	92627
	cream white RAL 9001		92630 *	92632 *	92634 *	-	-		92631 *	92633 *	92635 *	-	-
	pearl white RAL 1013		92640 *	92642 *	92644 *	-	-		92641 *	92643 *	92645 *	-	-
	beige grey RAL 1019		92650 *	92652 *	92654 *	-	-		92651 *	92653 *	92655 *	-	-
	stone grey RAL 7030		92660 *	92662 *	92664 *	-	-		92661 *	92663 *	92665 *	-	-
	light grey RAL 7035		92670 *	92672 *	92674 *	-	-		92671 *	92673 *	92675 *	-	-
	red RAL 3002		92680 *	92682 *	92684 *	-	-		92681 *	92683 *	92685 *	-	-
	black RAL 9005		92590 *	92592 *	92594 *	-	-		92691 *	92693 *	92695 *	-	-
	<i>euro/pc</i>												

no partial packaging

Complete the article code with H measure
(for example TA/ for H=8 becomes TA/8)

* available upon request pack of 1 pc in blister
+ Euro (for example TA/6 code 92606 becomes 92606/B)

* Out of production items, available till end of stock

For a single piece, see sales conditions on page 305



RAS/10 bright satin silver aluminium



RB/10 bright polished gold aluminium



RI/10 stainless steel AISI 304 DIN 1.4301

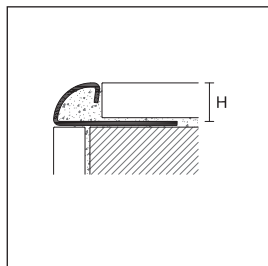

RIL/10 + TIEL/10 superpolished stainless steel

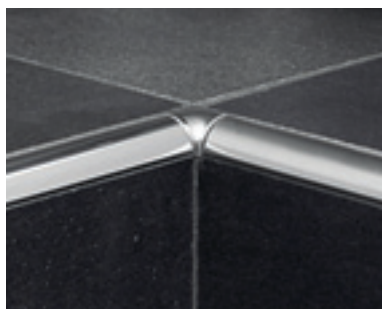

RIL/10 + TIIL/10 superpolished stainless steel

PROTRIM in stainless steel offers a unique combination of design and functionality. It has excellent resistance to corrosion and chemical resistance. The versions in AISI 304 are recommended in food processing, kitchens, hospitals and outdoor environments; the versions in AISI 316 are suggested in "difficult" application where they can undergo the attack of chlorine and its compounds swimming pools, spa and places exposed to salt.

PROTRIM

length = 270 cm - pack 20 pcs

		H								
ART.	finishing	4,5	6	8	9	10	11	12,5	15	
STAINLESS STEEL										
RI/	stainless steel AISI 304 DIN 1.4301 <i>euro/m</i>		92413	92420	92422	92423	92424	92425	92426	92428
RIL/	superpolished stainless steel AISI 304 - DIN 1.4301 <i>euro/m</i>		92415	92416	92417	-	92418	-	92419	-
RIS/	satin stainless steel AISI 304 - DIN 1.4301 <i>euro/m</i>		-	92430	92431	92438	92432	92439	92433	92434
RIP/	sandblasted stainless steel AISI 304 - DIN 1.4301 <i>euro/m</i>		-	92450	92451	92452	92453	92454	92455	-
RIX/	stainless steel AISI 316 - DIN 1.4404 <i>euro/m</i>		92405	92406	92407	92410	92408	92411	92409	-
individually packed - art. RI/15 pack 10 pcs										
OUTSIDE CORNER - packaging of 5 pcs										
TIE/	stainless steel AISI 304 - DIN 1.4301 <i>euro/pc</i>		92750	92480	92481	92751	92482	92752	92483	92484
TIEL/	superpolished stainless steel AISI 304 - DIN 1.4301 <i>euro/pc</i>		92790	92792	92794	-	92798	-	92802	-
TIES/	satin stainless steel AISI 304 - DIN 1.4301 <i>euro/pc</i>		-	92485	92486	92753	92487	92754	92488	92489
TIEP/	sandblasted stainless steel AISI 304 - DIN 1.4301 <i>euro/pc</i>		-	92510	92511	92512	92513	92514	92515	-
TIEX/	stainless steel AISI 316 - DIN 1.4404 <i>euro/pc</i>		92500	92501	92502	92755	92503	92756	92504	-
INSIDE CORNER - packaging of 5 pcs										
TII/	stainless steel AISI 304 - DIN 1.4301 <i>euro/pc</i>		92759	92490	92491	92757	92492	92758	92493	92494
TIIL/	stainless steel superpolished AISI 304 - DIN 1.4301 <i>euro/pc</i>		92791	92793	92795	-	92799	-	92803	-
TIIS/	satin stainless steel AISI 304 - DIN 1.4301 <i>euro/pc</i>		-	92495	92496	92760	92497	92761	92498	92499
TIIP/	sandblasted stainless steel AISI 304 - DIN 1.4301 <i>euro/pc</i>		-	92516	92517	92518	92519	92520	92521	-
TIIX/	stainless steel AISI 316 - DIN 1.4404 <i>euro/pc</i>		92505	92506	92507	92762	92508	92763	92509	-
METAL										
OUTSIDE CORNER - packaging of 5 pcs										
TIME/	polished stainless steel <i>euro/pc</i>		-	-	92960	-	92964	92966	-	-
INSIDE CORNER - pack da 5 pcs										
TIMI/	polished stainless steel <i>euro/pc</i>		-	-	92970	-	92974	92976	-	-

Angles available on request pack of 1 pc in blister + Euro (for example TIME/8 code 92960 becomes 92960/B)

Complete the article code with H measure (for example RI/ for H=8 becomes RI/8)

For insertion and adjustment of corners TIME/ and TIMI/ we recommend the use of adhesive type PP/96

For a single piece, see sales conditions on page 305

corners TIME/ and TIMI/ no partial packaging

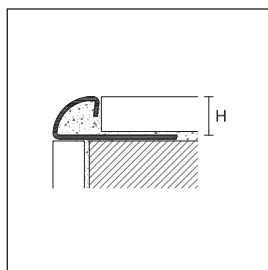

RKN/10 chromium-plated brass

RLN/
RKN/

RIN/10 stainless steel AISI 304 - DIN 1.4301

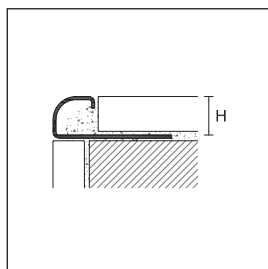
RIN/
RINS/
RINX/**PROTRIM**

length = 270 cm - pack 20 pcs

		H				
ART.	finishing	6	8	10	12,5	
POLISHED/CHROMIUM-PLATED BRASS						
RLN/	polished		92465	92466	92467	92468
<i>euro/m</i>						
RKN/	chromium plated		92469	92470	92471	92472
<i>euro/m</i>						

individually packed - art. RLN/10, RLN/12,5, RKN/10, RKN/12,5 pack 10 pcs

OUTSIDE CORNERS FOR RLN/ ARTICLES - packaging of 5 pcs

ALUMINIUM

TB/	bright polished gold		92700	92702	92704	92706
<i>euro/pc</i>						

INSIDE CORNERS FOR RLN/ ARTICLES - packaging of 5 pcs

ALUMINIUM

TIB/	bright polished gold		92585	92586	92587	92588
<i>euro/pc</i>						

no partial packaging

OUTSIDE CORNERS IN SUPERPOLISHED STAINLESS STEEL FOR RKN/ ITEMS - packaging of 5 pcs

STAINLESS STEEL

TIEL/	superpolished stainless steel AISI 304 DIN 1.4301		92792	92794	92798	92802
<i>euro/pc</i>						

INSIDE CORNERS IN SUPERPOLISHED STAINLESS STEEL FOR RKN/ ITEMS - packaging of 5 pcs

STAINLESS STEEL

TIIL/	superpolished stainless steel AISI 304 DIN 1.4301		92793	92795	92799	92803
<i>euro/pc</i>						

PROTRIM N

length = 270 cm - pack 20 pcs

		H			
ART.	finishing	8	10	12,5	
STAINLESS STEEL					
RIN/	stainless steel AISI 304 - DIN 1.4301		92353	92356	92359
<i>euro/m</i>					
RINS/	satın stainless steel AISI 304 - DIN 1.4301		92354	92357	92360
<i>euro/m</i>					
RINX/	stainless steel AISI 316 - DIN 1.4404		92355	92358	92361
<i>euro/m</i>					

individually packed

OUTSIDE CORNERS - packaging of 5 pcs

TIEN/	stainless steel AISI 304 - DIN 1.4301		92813	92816	92819
<i>euro/pc</i>					
TIENS/	satın stainless steel AISI 304 - DIN 1.4301		92814	92817	92820
<i>euro/pc</i>					
TIENX/	stainless steel AISI 316 - DIN 1.4404		92815	92818	92821
<i>euro/pc</i>					

INSIDE CORNERS - packaging of 5 pcs

TIIN/	stainless steel AISI 304 - DIN 1.4301		92828	92831	92834
<i>euro/pc</i>					
TIINS/	satın stainless steel AISI 304 - DIN 1.4301		92829	92832	92835
<i>euro/pc</i>					
TIINX/	stainless steel AISI 316 - DIN 1.4404		92830	92833	92836
<i>euro/pc</i>					

Complete the article code with H measure
(for example RLN/ for H=8 becomes RLN/8)

For a single piece, see sales conditions on page 305

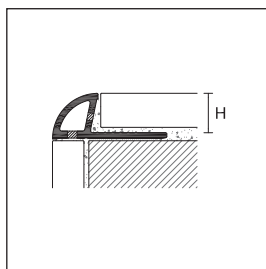

RPA/

RPA coextruded PVC, thanks to the special section with inserts in plastic PVC, absorbs micro-movements that are downloaded on the corner due to the tension of the walls.

RPA/8 co-extruded PVC

PROTRIM

length = 270 cm - pack 20/100 pcs*				H						
ART.	RPA/			TPAE/			TPAI/			
CO-EXTRUDED PVC				POLYPROPYLENE						
finishing				OUTSIDE CORNER			INSIDE CORNER			
	6	8	10	6	8	10	6	8	10	
snow white		80640	80641	80642	80700	80701	80702	80753	80751	80752
white		80644	80645	80646	80703	80704	80705	80750	80754	80755
cream white RAL 9001		80648	80649	80650	80706	80707	80708	80756	80757	80758
ivory RAL 1015		80652	80653	80654	80709	80710	80711	80759	80760	80761
beige grey RAL 1019		80656	80657	80658	80712	80713	80714	80762	80763	80764
stone grey RAL 7030		80660	80661	80662	80715	80716	80717	80765	80766	80767
ash grey RAL 7038		80664	80665	80666	80718	80719	80720	80768	80769	80770
light grey RAL 7035		80668	80669	80670	80721	80722	80723	80771	80772	80773
beige bahama		80680	80681	80682	80730	80731	80732	80780	80781	80782
brown		80692	80693	80694	80739	80740	80741	80789	80790	80791
pack 20 pcs <i>euro/m</i>				-	-	-	-	-	-	-
pack 100 pcs <i>euro/m</i>				-	-	-	-	-	-	-
pack 12 pcs <i>euro/pc</i>				-	-	-	-	-	-	-

no partial packaging

Complete the article code with H measure (for example RPA/ for H=8 becomes RPA/8)

* available upon request pack of 1 pc in blister + Euro (e.g. TPAE/8 code 80701 becomes 80701/B)

To order corners in packs of 50 pcs, mark /50 after article code (for example code 80700 becomes 80700/50) - pack of 50 pcs Euro

To order profiles in packs of 100 pcs, mark /100 after article code (for example code 80640 becomes 80640/100)

For a single piece, see sales conditions on page 305



RE/8 PVC red RAL 3002



REM/8 light green marbled PVC

PVC

- non-toxic
- anti-shock
- UV resistant

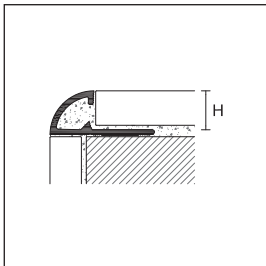

RE/

RE/
REL/
REM/

PROTRIM

lengt=270 cm - pack 20/100 pcs

ART. finishing	H							
	RE/ PVC				REL/ SUPERPOLISHED PVC			
	6	8	10	12,5	6	8	10	
snow white	79996	79997	79998	79999	79500	79501	79502	
white	80100	80101	80102	80103	-	-	-	
cream white RAL 9001	80104	80105	80106	80107	-	-	-	
ivory RAL 1015	80108	80109	80110	-	-	-	-	
beige grey RAL 1019	80112	80113	80114	-	-	-	-	
stone grey RAL 7030	80116	80117	80118	-	-	-	-	
ash grey RAL 7038	80120	80121	80122	-	-	-	-	
light grey RAL 7035	80124	80125	80126	80127	-	-	-	
anthracite	80175	80176	80177	-	-	-	-	
blue	80160	80161	80162	-	-	-	-	
pastel blue	80140	80141	80142	-	-	-	-	
light green	80179	80180	80181	-	-	-	-	
red RAL 3002	80128	80129	80130	-	-	-	-	
black RAL 9005	80132	80133	80134	-	-	-	-	
yellow RAL 1023	80136	80137	80138	-	-	-	-	
pastel pink	80144	80145	80146	-	-	-	-	
beige bahama	80150	80151	80152	-	-	-	-	
peach	80154	80155	80156	-	-	-	-	
caramel	80164	80165	80166	-	-	-	-	
brown	80168	80169	80170	-	-	-	-	
dark brown	80172	80173	80174	-	-	-	-	
coral red	80187	80188	80189	-	-	-	-	
raw sienna	80191	80192	80193	-	-	-	-	
terracotta	80195	80362	80194	-	-	-	-	
pack 20 pcs euro/m								
pack 100 pcs euro/m								

no partial packaging - to order the pack of 100 pcs, mark /100 after article code

PROTRIM

lengt=270 cm - pack 20/100 pcs

ART. finishing	H	
	REM/ MARBLED PVC	
	8	10
white	79701	79702
sand	79705	79706
light cream	79709	79710
dark cream	79713	79714
ivory	79717	79718
light beige	79721	79722
dark beige	79725	79726
pink	79729	79730
light blue	79733	79734
blue	79737	79738
light green	79741	79742
dark green	79745	79746
dark grey	79749	79750
bordeaux	79753	79754
travertine	79757	79758
pack 20 pcs euro/m		
pack 100 pcs euro/m		

no partial packaging - to order the pack of 100 pcs, mark /100 after article code

Complete the article code with H measure
(for example RE/ for H=8 becomes RE/8)

For RE corners see next page

Items REL available in different colours on demand - mini-quantity 2700 meters for colour

For a single piece, see sales conditions on page 305

CORNERS FOR RE

packaging of 12 pcs*		H				H			
ART.		TE/				TE/			
finishing		POLYPROPYLENE				POLYPROPYLENE			
		OUTSIDE CORNER				INSIDE CORNER			
		6	8	10	12,5	6	8	10	12,5
snow white		80396	80397	80398	80399	79800	79801	79802	79803
white		80400	80401	80402	80403	79804	79805	79806	79807
cream white RAL 9001		80404	80405	80406	80407	79808	79809	79810	79811
ivory RAL 1015		80408	80409	80410	-	79812	79813	79814	-
beige grey RAL 1019		80412	80413	80414	-	79816	79817	79818	-
stone grey RAL 7030		80416	80417	80418	-	79820	79821	79822	-
ash grey RAL 7038		80420	80421	80422	-	79824	79825	79826	-
light grey RAL 7035		80424	80425	80426	80427	79828	79829	79830	79831
anthracite		80479	80480	80481	-	79875	79876	79877	-
blue		80470	80471	80472	-	79848	79849	79850	-
pastel blue		80440	80441	80442	-	79844	79845	79846	-
light green		80475	80476	80477	-	79879	79880	79881	-
red RAL 3002		80428	80429	80430	-	79832	79833	79834	-
black RAL 9005		80432	80433	80434	-	79836	79837	79838	-
yellow RAL 1023		80436	80437	80438	-	79840	79841	79842	-
pastel pink		80444	80445	80446	-	79852	79853	79854	-
beige bahama		80448	80449	80450	-	79856	79857	79858	-
peach		80452	80453	80454	-	79860	79861	79862	-
caramel		80458	80459	80460	-	79864	79865	79866	-
brown		80462	80463	80464	-	79868	79869	79870	-
dark brown		80466	80467	80468	-	79872	79873	79874	-
coral red		80483	80484	80485	-	79887	79888	79889	-
raw sienna		80487	80488	80489	-	79891	79892	79893	-
terracotta		80491	80492	80493	-	79895	79896	79897	-

euro/pc

no partial packaging

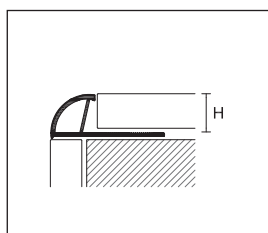

RECO/

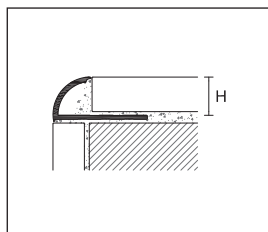

REC/

Complete the article code with H measure
(for example REC/ /100 for H=8 becomes REC/8/100)

* available upon request pack of 1 pc in blister
+ Euro (for example TE/8 code 80397 becomes 80397/B)

To order corners in packs of 50 pcs, mark /50 after article code (for example code 80396 becomes 80396/50)
pack of 50 pcs. €/pz

* Out of production items, available till end of stock

For a single piece, see sales conditions on page 305

PROTRIM ECO

length = 260 cm - pack 80 pcs

ART.	RECO/ /80*			
finishing	ECOLINE PVC			
	6	8	10	
snow white		79400	79401	79402
white		79403	79404	79405
cream white RAL 9001		79406	79407	79408
ivory RAL 1015		79409	79410	79411
beige grey RAL 1019		-	-	-
stone grey RAL 7030		-	-	-
ash grey RAL 7038		79412	79413	79414
light grey RAL 7035		79415	79416	79417
beige bahama		79418	79419	79420
brown		-	-	-

euro/m

no partial packaging

* RECO/colors available on request also marbled, minimum order 2600 mt
REC and RECO others colour on request for minimum 2600 mt for colour.

length = 260 cm - pack 100 pcs

RECO/ /100	
ECOLINE PVC	
8	10
79601/100	79602/100
-	-
79605/100	79606/100
79609/100 *	79610/100
79613/100 *	79614/100
79617/100 *	79618/100
79621/100 *	79622/100
79625/100 *	79626/100
79641/100 *	79642/100
79653/100 *	79654/100 *



Proangle F is a triangular profile indicated as a decorative element and closing of the outside corners of the tiles. The stainless steel version with reduced base is rather suitable for the protection and finishing of the interior angles of ceramic coverings.

FMB/10 + FMBE/10 bright polished silver aluminium

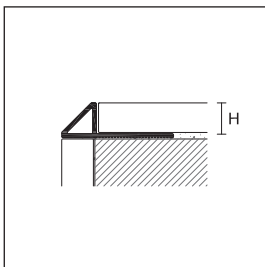

FMA/
FMB/

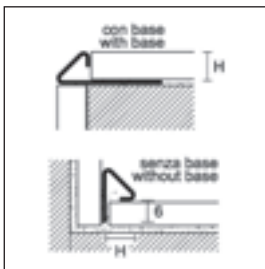

FMI/
FMIS/

PROANGLE F

		length = 270 cm - pack 20 pcs			H	
ART.	finishing	8	10	12,5		
ALUMINIUM						
FMA/	silver anodised		93025	93026	93027	
	<i>euro/m</i>					
FMB/	bright polished silver		93028	93029	93030	
	<i>euro/m</i>					

individually packed

PROANGLE F

		length = 270 cm - pack 20 pcs				H	
ART.	finishing	8		10			
STAINLESS STEEL							
FMI/	stainless steel AISI 304 - DIN 1.4301		con base	senza base	con base	senza base	
	<i>euro/m</i>		93050	93051	93052	93053	
FMIS/	satin stainless steel AISI 304 - DIN 1.4301		93054	93055	93056	93057	
	<i>euro/m</i>						

individually packed

OUTSIDE CORNER

packaging of 5 pcs* H

ART.	finishing	8	10	12,5
ALUMINIUM				
FMAE/	silver anodised		93031	93032 93033
	<i>euro/pc</i>			
FMBE/	bright polished silver		93040	93041 93042
	<i>euro/pc</i>			

OUTSIDE CORNER

packaging of 5 pcs H

ART.	finishing	8	10
STAINLESS STEEL			
FMIE/	stainless steel AISI 304 - DIN 1.4301		93058 93059
	<i>euro/pc</i>		
FMIES/	satin stainless steel AISI 304 - DIN 1.4301		93064 93065
	<i>euro/pc</i>		

INSIDE CORNER

packaging of 5 pcs* H

ART.	finishing	8	10	12,5
ALUMINIUM				
FMAI/	silver anodised		93034	93035 93036
	<i>euro/pc</i>			
FMBI/	bright polished silver		93043	93044 93045
	<i>euro/pc</i>			

INSIDE CORNER

packaging of 5 pcs H

ART.	finishing	8	10
STAINLESS STEEL			
FMII/	stainless steel AISI 304 - DIN 1.4301		93060 93061
	<i>euro/pc</i>		
FMIIS/	satin stainless steel AISI 304 - DIN 1.4301		93066 93067
	<i>euro/pc</i>		

END CAP

packaging of 5 pcs* H

ART.	finishing	8	10	12,5
ALUMINIUM				
FMAC/	silver anodised		93037	93038 93039
	<i>euro/pc</i>			
FMBC/	bright polished silver		93046	93047 93048
	<i>euro/pc</i>			

END CAP

packaging of 5 pcs H

ART.	finishing	8	10
STAINLESS STEEL			
FMIC/	stainless steel AISI 304 - DIN 1.4301		93062 93063
	<i>euro/pc</i>		
FMICS/	satin stainless steel AISI 304 - DIN 1.4301		93068 93069
	<i>euro/pc</i>		

no partial packaging for accessori in aluminium

* available upon request pack of 1pc in blister + Euro (e.g. FMAE/8 code 93031 becomes 93031/B) - Complete the article code with H measure (for example FMA/ for H=8 becomes FMA/8) - For a single piece, see sales conditions on page 305



AI/10 stainless steel AISI 304 - DIN 1.4301



ZBS/ bright satin black aluminium

Proangle is a line of profiles to be used for sealing and protecting external corners of wall tiles, avoiding the unsightly and fragile cut at 45°. Its square shape defines clearly the installation of coverings as rectified porcelain stoneware. It is available in different materials, colors and finishes and it is therefore also used for decorative purposes, with refined and pleasant effects of combination / contrast with the wide variety of wall coverings. ZVH/, used as sealing and protection profile for external corners of ceramic coverings, is provided with the certified antibacterial technology (according to the strict test internationally recognised JIS Z 2801:2000) which allows to reduce the presence of the most dangerous bacteria up until 99%, thus assuring the best hygienic level over time.

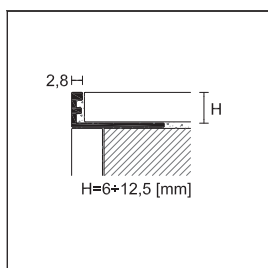
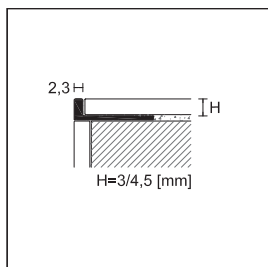

PROANGLE

length = 270 cm - pack 20 pcs

ART.	finishing	H								
		3	4,5	6	8	9	10	11	12,5	
ALUMINIUM										
ZA/	silver anodised		90338	90340	88204	88205	88217	88206	88218	88207
	titanium anodised		-	-	88253	88254	-	88255	-	88256
<i>euro/m</i>										
ZA/	black anodised		-	-	-	88265	-	88266	88267	88268
<i>euro/m</i>										
ZB/	bright polished silver		-	88260	88294	88295	-	88296	88220	88297
<i>euro/m</i>										
ZB/	bright polished gold		-	88261	88339	88340	-	88341	-	88342
	bright polished titanium		-	90341	88344	88345	-	88346	88348	88347
<i>euro/m</i>										
ZBS/	bright satin silver		-	-	-	-	-	88356	88357	88358
ZTM/	bright satin titanium		-	-	-	-	-	88359	88360	88361
<i>euro/m</i>										
ZBS/	bright satin black		-	-	-	-	-	88353	88354	88355
<i>euro/m</i>										
ZV/	colour-coated matt white		-	-	-	88395	-	88396	-	88397
	colour-coated white		-	-	88384	88385	-	88386	-	88387
	RAL 9003		-	-	-	-	-	-	-	-
<i>euro/m</i>										
ANTIBACTERIAL COLOUR-COATED ALUMINIUM										
ZVH/	colour-coated white		-	-	-	88390	-	88392	-	88394
<i>euro/m</i>										

individually packed

Complete the article code with H measure (for example ZA/ for H=8 becomes ZA/8)

Items ZV/ available in different colours on demand - minimum quantity 540 meters for colour.

Proangle: for different heights till 30 mm please see page 119

Items ZA-AI bendable version see page 223

For a single piece, see sales conditions on page 305

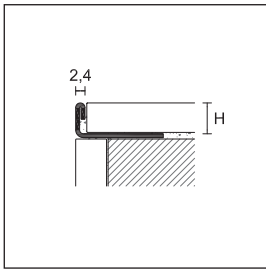

PROANGLE

length = 270 cm - pack 20 pcs

		H									
ART.	finishing	3	4,5	5	6	8	9	10	11	12,5	
STAINLESS STEEL											
AI/	stainless steel AISI 304 - DIN 1.4301 <i>euro/m</i>		91636	91638	91640	91642	91644	91645	91646	91647	91648
AII/	superpolished stainless steel AISI 304 - DIN 1.4301 <i>euro/m</i>		-	91690	-	-	91694	-	91696	-	91698
AIS/	satin stainless steel AISI 304 - DIN 1.4301 <i>euro/m</i>		-	91671	-	91673	91674	-	91675	91677	91676
AIP/	sandblasted stainless steel AISI 304 - DIN 1.4301 <i>euro/m</i>		-	-	-	91700	91702	-	91704	91705	91706
AIX/	stainless steel AISI 316 - DIN 1.4404 <i>euro/m</i>		-	-	-	91684	91685	-	91686	91688	91687
CHROMIUM-PLATED BRASS											
ZK/	chromium plated <i>euro/m</i>		90079	90081	-	88114	88115	-	88116	88118	88117

individually packed

PVC

- non-toxic
- anti-shock
- UV resistant



PV/8 PVC beige grey

PROANGLE

length = 270 cm

		H					
ART.	finishing	4,5	6	8	10	12,5	
PVC							
	snow white		80610	80496	80497	80498	80499
	white		80611	80500	80501	80502	80503
	cream white RAL 9001		-	80504	80505	80506	80507
	ivory RAL 1015		-	80508	80509	80510	-
	beige grey RAL 1019		-	80512	80513	80514	-
	beige bahama		-	80552	80553	80554	-
PV/	stone grey RAL 7030		-	80516	80517	80518	-
	ash grey RAL 7038		-	80520	80521	80522	-
	light grey RAL 7035		-	80524	80525	80526	80527
	anthracite		-	80559	80560	80561	-
	red RAL 3002		-	80528	80529	80530	-
	black RAL 9005		-	80532	80533	80534	-

pack 20 pcs
euro/m

pack 100 pcs
euro/m

no partial packaging

to order the pack of 100 pcs, mark /100 after article code

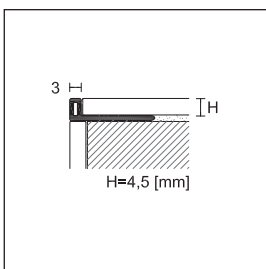

PV/

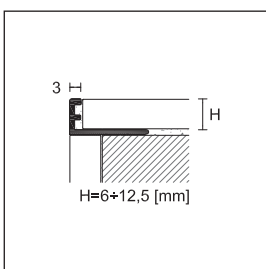

PV/

Complete the article code with H measure (for example PV/ for H=8 becomes PV/8) - Items PV/ available in different colours on demand - minimum quantity 2700 meters for colour
For a single piece, see sales conditions on page 305



ZQAGN/10 bright scratched silver aluminium

Proangle Q is a line of universal profiles specifically designed to edge and protect the external corners of ceramic coverings. The square shape clearly defines the laying of the wall coverings, thus avoiding the unsightly and fragile 45 degrees cut of the tiles. They are also particularly suitable for the edging and the protection of floors and steps in different materials, such as ceramic, stone, wood and resins; moreover, they can be used as finishing of worktops and platforms.

ZQVNH/, used as edging and protection of the external corners of ceramic coverings, is provided with the certified antibacterial technology (according to the internationally recognized laboratory test JIS Z 2801:2000) which allows to reduce the presence of the most dangerous bacteria up to 99%, thus assuring the best hygienic level over time.

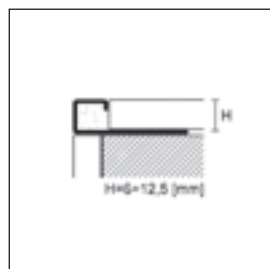
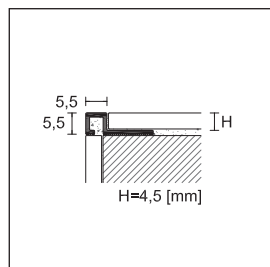

Also available ZQVN/ TREND COLOR Light and Stone, go on page 30 and 34

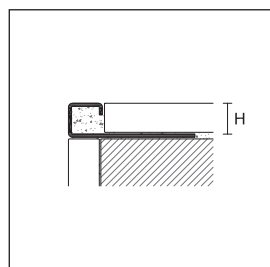

April 2020: ZQBN/8-10-12,5 available in another new titanium finish.

Complete the article code with H measure (for example ZQAN/ for H=8 becomes ZQAN/8)

Items ZQVN available in different colours on demand - minimum quantity 540 meters for colour

* Out of production items, available till end of stock

For a single piece, see sales conditions on page 305

PROANGLE Q

length = 270 cm - pack 20 pcs

ART.	finishing	H								
		4,5	6	8	9	10	11	12,5	15	
ALUMINIUM										
ZQAN/	silver anodised		88772	88875	88876	88877	88878	88879	88880	-
	titanium anodised		88902	88903	88904	88905	88906	88907	88908	-
	<i>euro/m</i>									-
ZQAN/	black anodised		-	-	89205	-	89206	89207	89208	-
	<i>euro/m</i>									-
ZQBN/	bright polished silver		88816	88919	88920	88921	88922	88923	88924	-
	<i>euro/m</i>									-
ZQBN/	bright polished gold		88933	-	88935	-	88937	-	88939	-
ZQTN/	bright polished titanium		88949	88950	88951	88952	88953	88954	88955	-
ZQBRN/	bright polished copper		-	-	88967 *	-	88969	-	88971	-
	<i>euro/m</i>									-
ZQBSN/	bright satin silver		88981	88982	88983	-	88985	88986	88987	-
	bright satin gold		88997	-	88999	-	89001	-	89003	-
ZQTMN/	bright satin titanium		89013	89014	89015	-	89017	-	89019	-
ZQBRSN/	bright satin copper		-	-	89031	-	89033	-	89035	-
	<i>euro/m</i>									-
ZQBSN/	bright satin black		-	-	-	-	89209	89210	89211	-
	<i>euro/m</i>									-
ZQAGN/	bright scratched silver		89061	-	89063	-	89065	-	89067	-
	<i>euro/m</i>									-
ZQVN/	colour-coated matt white RAL 9003		-	-	89200	-	89202	89203	89204	-
	colour-coated white RAL 9003		89077	89076	89079	-	89081	89078	89083	-
	<i>euro/m</i>									-
ANTIBACTERIAL COLOUR-COATED ALUMINIUM										
ZQVNH/	colour-coated white RAL 9003		-	-	89080	-	89082	-	89084	-
	<i>euro/m</i>									-
STAINLESS STEEL										
ZQIN/	stainless steel AISI 304 - DIN 1.4301		-	90049	90050	90051	90052	90053	90054	90055
	<i>euro/m</i>									-
ZQINS/	satin stainless steel AISI 304 - DIN 1.4301		-	90100	90101	90102	90103	90104	90105	90106
ZQINP/	sandblasted stainless steel AISI 304 - DIN 1.4301		-	90130	90131	90132	90133	90134	90135	90136
	<i>euro/m</i>									-
ZQINX/	stainless steel AISI 316 - DIN 1.4404		-	-	90107	-	90109	-	90111	-
	<i>euro/m</i>									-
POLISHED/CHROMIUM-PLATED BRASS										
ZQLN/	polished		90022	-	90056	-	90057	90063	90058	-
	<i>euro/m</i>									-
ZQKN/	chromium plated		88870	-	90059	-	90060	90074	90061	-
	<i>euro/m</i>									-

individually packed - ZQIN/15, ZQINS/15 and ZQINP/15 packaging of 10 pcs



ZQIN/10/EI stainless steel AISI 304 - DIN 1.4301



ZQIN/10/EI stainless steel AISI 304 - DIN 1.4301

PROANGLE Q

pack 5 pcs*		H								
ART.	finishing	4,5	6	8	9	10	11	12,5	15	
OUTSIDE / INSIDE CORNERS / END CAPS										
ALUMINIUM										
ZQAN/ /EI	silver anodised		88809	88882	88883	88884	88885	88886	88887	-
	titanium anodised		88910	88911	88912	88913	88914	88915	88916	-
<i>euro/pc</i>										
ZQAN/ /EI	black anodised		-	-	89223	-	89224	89225	89226	-
			-	-						-
ZQBN/ /EI	bright polished silver		88829	88926	88927	88928	88929	88930	88931	-
	bright polished gold		88941	-	88943	-	88945	-	88947	-
	colour-coated matt white RAL 9003		-	-	89192	-	89194	89195	89196	-
ZQVN/ /EI	colour-coated white RAL 9003		89085	89086	89087	-	89089	89088	89091	-
										-
ZQTV/ /EI	bright polished titanium		88957	88958	88959	88960	88961	88962	88963	-
ZQBRN/ /EI	bright polished copper		-	-	88975 *	-	88977	-	88979	-
ZQBSN/ /EI	bright satin silver		88989	88990	88991	-	88993	88994	88995	-
	bright satin gold		89005	-	89007	-	89009	-	89011	-
ZQTMN/ /EI	bright satin titanium		89021	89022	89023	-	89025	-	89027	-
ZQBSNV/ /EI	bright satin copper		-	-	89039	-	89041	-	89043	-
ZQBSN/ /EI	bright satin black		-	-	-	-	89227	89228	89229	-
<i>euro/pc</i>										
ZQAGN/ /EI	bright scratched silver		89069	-	89071	-	89073	-	89075	-
<i>euro/pc</i>										

no partial packaging

STAINLESS STEEL

pack 5 pcs		H								
ART.	finishing	4,5	6	8	9	10	11	12,5	15	
ZQIN/ /EI	stainless steel AISI 304 - DIN 1.4301		-	90064	90065	90066	90067	90068	90069	90070
<i>euro/pc</i>										
ZQINS/ /EI	satin stainless steel AISI 304 - DIN 1.4301		-	90112	90113	90114	90115	90116	90117	90118
ZQINP/ /EI	sandblasted stainless steel AISI 304 - DIN 1.4301		-	90137	90138	90139	90140	90141	90142	90143
<i>euro/pc</i>										
ZQINX/ /EI	stainless steel AISI 316 - DIN 1.4404		-	-	90119	-	90121	-	90123	-
<i>euro/pc</i>										

POLISHED/CHROMIUM-PLATED BRASS

ZQLN/ /EI	polished		90062	-	90071	-	90072	90075	90073	-
<i>euro/pc</i>										
ZQKN/ /EI	chromium plated		88872	-	90077	-	90083	90085	90087	-
<i>euro/pc</i>										

METAL

ZQIM/ /EI	polished stainless steel		-	-	90092	90093	90094	90095	90096	-
<i>euro/pc</i>										
ZQIMS/ /EI	satin steel		-	-	90152	90153	90154	90155	90156	-
<i>euro/pc</i>										
ZQIMP/ /EI	sandblasted steel		-	-	90162	90163	90164	90165	90166	-
<i>euro/pc</i>										

no partial packaging for ZQIM/ /EI, ZQIMS/ /EI and ZQIMP/ /EI

Complete the article code with H measure
(for example ZQAN/ /EI for H=8 becomes ZQAN/8/EI)

* available upon request pack of 1 pc in blister + €
(for example ZQAN/8/EI code 88883 becomes code 88883/B)

* Out of production items, available till end of stock

For a single piece, see sales conditions on page 305



ZQBSN/ bright satin black aluminium



ZQAN/ black anodised aluminium



ZQKN/ chromium-plated brass

PVC

- non-toxic
- anti-shock
- UV resistant

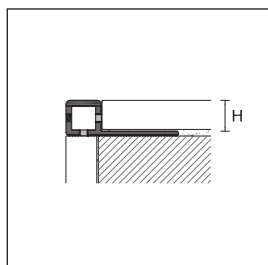

ZQP/

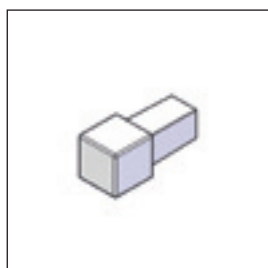

ZQP//EI

PROANGLE Q

length = 270 cm		H				
ART.	finishing	6	8	10	12,5	
CO-EXTRUDED PVC						
	white		80800	80801	80802	80803
	cream white RAL 9001		80804	80805	80806	80807
	ivory RAL 1015		80808	80809	80810	80811
	beige grey RAL 1019		80812	80813	80814	80815
ZQP/	stone grey RAL 7030		80816	80817	80818	80819
	light grey RAL 7035		80820	80821	80822	80823
	anthracite		80824	80825	80826	80827
	beige bahama		80832	80833	80834	80835
	brown		80836	80837	80838	80839
pack 20 pcs						
euro/m						
pack 80 pcs						
euro/m						
pack 100 pcs						
euro/m						

no partial packaging
to order the pack of 80 or 100 pcs, mark /80 or /100 after article code

OUTSIDE / INSIDE CORNERS / END CAPS

PROANGLE

pack 12 pcs*		H				
ART.	finishing	6	8	10	12,5	
POLYPROPYLENE						
	white		80850	80851	80852	80853
	cream white RAL 9001		80854	80855	80856	80857
	ivory RAL 1015		80858	80859	80860	80861
	beige grey RAL 1019		80862	80863	80864	80865
ZQP//EI	stone grey RAL 7030		80866	80867	80868	80869
	light grey RAL 7035		80870	80871	80872	80873
	anthracite		80874	80875	80876	80877
	beige bahama		80882	80883	80884	80885
	brown		80886	80887	80888	80889
euro/pc						

no partial packaging - pack of 50 pcs Euro

Complete the article code with H measure
(for example ZQP/ for H=8 becomes ZQP/8)

* available upon request pack of 1 pc in blister + Euro
(for example ZQP/8/EI code 80851 white becomes code 80851/B)

Colours available on demand - minimum quantity
2700 meters

To order corners ZQP//EI in pack of 50, mark /50 after
article code (for example code 80850 becomes 80850/50)

For a single piece, see sales conditions on page 305



ZQP/8 PVC white



ZQP/8 PVC beige bahama

cerfix® protrim IP - pronivel M



IPA/11 silver anodised aluminium

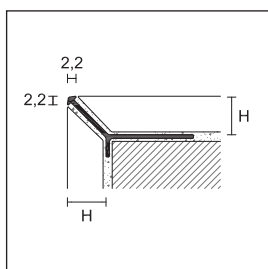

IPA/

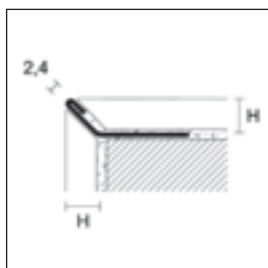

IPI/

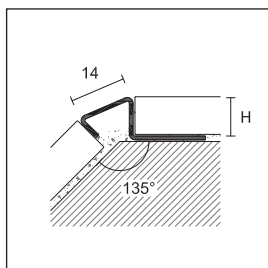

MIN/10

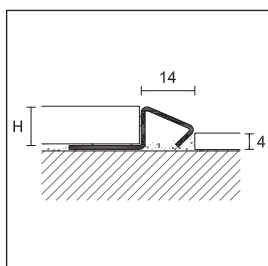

MIN/10 application for floors of different height

Protrim IPA/ and IPI/ are minimal profiles suitable for the edging of external corners that need the 45 degrees cut. These profiles allow a perfect laying both on coverings and on stairs or platforms in ceramic or wood.

PROTRIM IP

length = 270 cm - pack 20 pcs		H			
ART.	finishing	4,5	8	11	15
ALUMINIUM					
IPA/	silver anodised	95006	95178	95181	95185
	<i>euro/m</i>				
IPB/	bright polished silver	95008	-	-	-
	<i>euro/m</i>				

individually packed - for IPV in colour-coated aluminium see page 31

PROTRIM IP

length = 270 cm - pack 20 pcs		H			
ART.	finishing	7	8	11	12,5
STAINLESS STEEL					
IPI/	stainless steel AISI 304 - DIN 1.4301	95169	95170	95173	95174
	<i>euro/m</i>				

individually packed



MIN/10 polished stainless steel AISI 304 DIN 1.4301

Pronivel M is a line of profiles designed to connect floors of different heights during the installation. Thanks to the new shape MIN/, it can be used as sealing profile for the protection of external corners of tiled walls at 135°.

PRONIVEL M

length = 270 cm - pack 10 pcs		H	
ART.	finishing	8	10
MIN/	polished stainless steel AISI 304 - DIN 1.4301	93023	93024
	<i>euro/m</i>		

individually packed

Complete the article code with the height (eg. MIN/ with H=10 becomes MIN/10)

For a single piece, see sales conditions on page 305



210/A silver anodised aluminium

Procorner M is a line of protection profiles of the outside corners of wall to be applied on the surfaces of the tiles already laid. Procorner profiles are also available in self-adhesive version for a quick and easy installation.

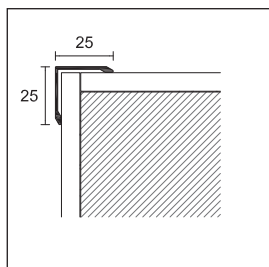

210/

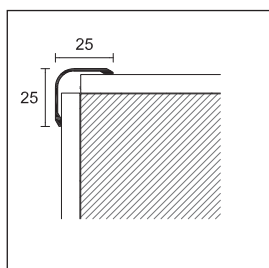

220/

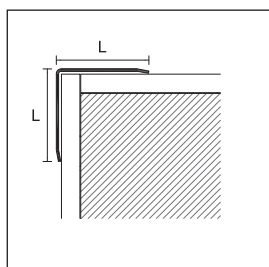



277/

Complete the article code with L measure (for example 277/SF/ for L= 20 becomes 277/SF/20)

Upon request, we can manufacture cerfix® procorner with different dimensions. Please contact our technical department for further information.



For a single piece, see sales conditions on page 305

PROCORNER M

length = 300 cm - pack 30 pcs		LxL	
		25x25	
ART.	finishing	/SF	/A
ALUMINIUM			
	silver anodised	 76068	76098
	gold anodised	 -	76108
210/	euro/m		
	colour-coated white RAL 9003	 76128	76208
	euro/m		

SF = not drilled A = adhesive
individually packed

PROCORNER M

length = 300 cm - pack 30 pcs		LxL	
		25x25	
ART.	finishing	/SF	/A
ALUMINIUM			
	silver anodised	 77888	77894
220/	euro/m		
	colour-coated white RAL 9003	 77900	77916 *
	euro/m		

SF = not drilled A = adhesive
individually packed

PROCORNER M

length = 300 cm - pack 30 pcs		LxL	
		20x20	
ART.	measure LxL	code	euro/m
277/SF/	20x20	76308	
277/A/ adhesive	20x20	76309	
277/SF/	25x25	76318	
277/A/ adhesive	25x25	76319	
277/SF/	30x30	76328	
277/A/ adhesive	30x30	76329	

individually packed



775/A40 polished stainless steel AISI 304 DIN 1.4301

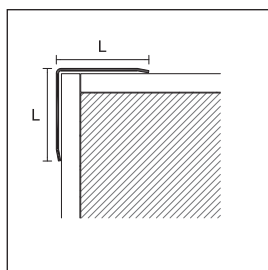

777/
776/

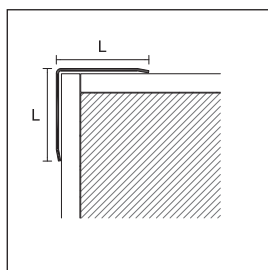

775/

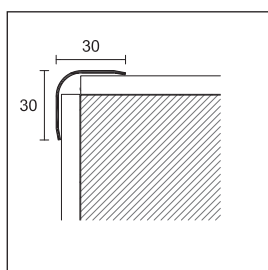

774/

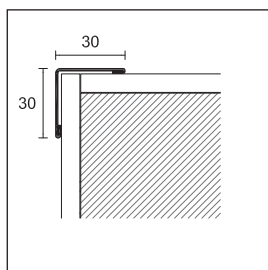

779/SF

Complete the article code with H measure
(for example 777/SF/ for L=15 becomes 777/SF/15)

Upon request, we can manufacture cerfix®
procorner with different dimensions.
Please contact our technical department for further
information.

For a single piece, see sales conditions on page 305

PROCORNER M

POLISHED STAINLESS STEEL AISI 430 DIN 1.4016

length = 300 cm - thickness = 0,60 mm

ART.	measure LxL	code	euro/m	pack
777/SF/	15x15	76888		30
777/A/ adhesive	15x15	76938		30
777/SF/	20x20	76898		30
777/A/ adhesive	20x20	76948		30
777/SF/	25x25	76908		15
777/A/ adhesive	25x25	76958		15
777/SF/	30x30	76918		20
777/A/ adhesive	30x30	76968		20

length = 200 cm - thickness = 1 mm

ART.	measure LxL	code	euro/m	pack
776/SF/	30x30	77004		20
776/A/ adhesive	30x30	77044		20
776/SF/	40x40	77014		10
776/A/ adhesive	40x40	77054		10
776/SF/	50x50	77024		10
776/A/ adhesive	50x50	77064		10

length = 270 cm - thickness = 1 mm

ART.	measure LxL	code	euro/m	pack
776/SF/	30x30	77008		10
776/A/ adhesive	30x30	77048		10
776/SF/	40x40	77018		10
776/A/ adhesive	40x40	77058		10
776/SF/	50x50	77028		5
776/A/ adhesive	50x50	77068		5

POLISHED STAINLESS STEEL AISI 304 DIN 1.4301

length = 270 cm - thickness = 1 mm

ART.	measure LxL	code	euro/m	pack
775/SF/	30x30	77108		10
775/A/ adhesive	30x30	77148		10
775/SF/	40x40	77118		10
775/A/ adhesive	40x40	77158 *		10
775/SF/	50x50	77128		5
775/A/ adhesive	50x50	77168		5

SATIN STAINLESS STEEL AISI 304 DIN 1.4301

length = 270 cm - thickness = 1 mm

ART.	measure LxL	code	euro/m	pack
775/SF/	30x30	77110		10
775/SF/	50x50	77130		5

POLISHED STAINLESS STEEL AISI 304 DIN 1.4301

length = 270 cm - thickness = 1 mm

ART.	measure LxL	code	euro/m	pack
774/SF	30x30	77954		10
774/A adhesive	30x30	77956 *		10

SATIN STAINLESS STEEL AISI 304 DIN 1.4301

length = 270 cm - thickness = 1 mm

ART.	measure LxL	code	euro/m	pack
779/SF	30x30	77106		10

SF = not drilled A = adhesive

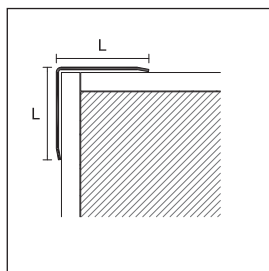

076/SF/
076/A/

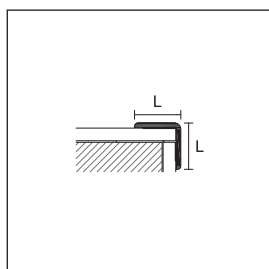

8610
8611

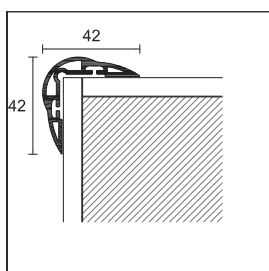

IP/40

Complete the article code with H measure
(for example 076/SF/ for L=15 becomes 076/SF/15)

Upon request, we can manufacture cerfix®
procorner with different dimensions.
Please contact our technical department for further
information.

Article IP/40 in PVC should be stored horizontally

For a single piece, see sales conditions on page 305

PROCORNER M

POLISHED BRASS

length = 270 cm - thickness = 1,00 mm

ART.	measure LxL	code	euro/m	pack
076/SF/	15x15	76800		30
076/A/ adhesive	15x15	76840		15
076/SF/	20x20	76802		15
076/A/ adhesive	20x20	76842		15
076/SF/	25x25	76806		15
076/A/ adhesive	25x25	76846		10
076/SF/	30x30	76808		10
076/A/ adhesive	30x30	76848		10
076/SF/	40x40	76818 *		5
076/A/ adhesive	40x40	76858 *		5

SF = not drilled A = adhesive

PVC LINE

length 300 cm / pack 50 pcs

ART.	finishing	LxL	LxL
FOAM PVC		24x24	24x24
8610	white - dec. 555		29840
	light grey - dec. 556		29842
	black - dec. 557		29844
	anthracite - dec. 558		29846
	euro/m		
8611	light blue 563		29847
	yellow 561		29848
	red 564		29849
	green 562		29850
	euro/m		
		30x30	30x30
8611	white - dec. 555		29940
	light grey - dec. 556		29942
	black - dec. 557		29944
	euro/m		
	light blue 563		29945
yellow 561		29946	
red 564		29947	
green 562		29948	
euro/m			

no partial packaging

Procorner P is an edge profile to protect from many issues. Recommended in environments such as schools, offices, kindergartens, public spaces, it is made of PVC soft and in bright colors to visually highlight the edges of the wall.

PROCORNER P

length = 270 cm - pack 20 pcs

ART.	finishing	LxL
PVC SOFT		42x42
IP/40	white	
	yellow	
	red	
	blue	
euro/m		

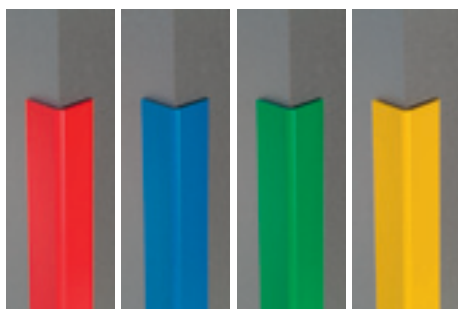

8610 - 8611



IP/40 PVC soft



076/A/30 polished brass



ILN/10 polished stainless steel AISI 304 DIN 1.4301

Stainless steel Probord ILN is a security profile for the outside corners of wall tiles. It can be combined with the profiles Proround M and it is recommended for the prevention of accidents and in environments where high hygienic safety is also required such as kitchens, food industries, schools etc.. The version in AISI 316 stainless steel is suitable for swimming pools, spa and in environments exposed to salt.

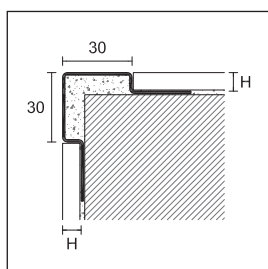

ILN/
ILNS/
ILNX/

PROBORD

length = 270 cm - pack 5 pcs		H			
ART.	finishing	8	10	12,5	
STAINLESS STEEL					
ILN/	polished stainless steel AISI 304 - DIN 1.4301 <i>euro/m</i>		94997	94998	94999
ILNS/	satin stainless steel AISI 304 - DIN 1.4301 <i>euro/m</i>		94984	94985	94986
ILNX/	stainless steel AISI 316 - DIN 1.4404 <i>euro/m</i>		94987	94988	94989

individually packed



IL/10 polished stainless steel AISI 304 DIN 1.4301

Probord IL, ILE and ILES have a rounded angle (compared to the model ILN). The fixing system with a single flange favors the correct alignment of the profile even in the presence of corners and uneven surfaces.

PROBORD

length = 270 cm - pack 10 pcs		H			
ART.	finishing	8	10	12,5	
STAINLESS STEEL					
IL/	stainless steel AISI 304 - DIN 1.4301 <i>euro/m</i>		94994	94995	94996

individually packed

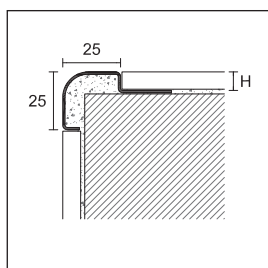

IL/

PROBORD

length = 270 cm - pack 5 pcs		H		
ART.	finishing	10		
STAINLESS STEEL				
ILE/10	polished stainless steel AISI 304 - DIN 1.4301 <i>euro/m</i>		95002	
ILES/10	satin stainless steel AISI 304 - DIN 1.4301 <i>euro/m</i>		95003	

individually packed

Upon request, we can manufacture ILE/ and ILES/ with different dimensions or in stainless steel AISI 316 - DIN 1.4404.

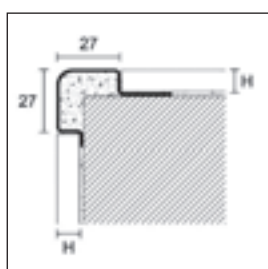

ILE/
ILES/

Complete the article code with H measure (for example ILN/ for H=8 becomes ILN/8)

Upon request, we can manufacture cerfix profiles, probord ILN/ and IL/ with different dimensions. Please contact our technical department for further information

For a single piece, see sales conditions on page 305



TOP/A/10 silver anodised aluminium

Cerfix Protop® is a profile for the protection and finishing of external corners of worktops and ceramic-coated kitchens. Also recommended for running boards and steps made with tiles.

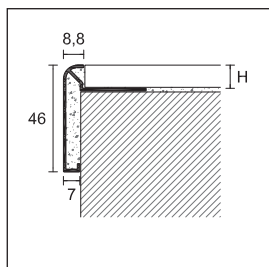

TOP/A/
TOP/TM/

PROTOP

length = 270 cm - pack 10 pcs H

ART.	finishing		10	12
ALUMINIUM				
TOP/A/	silver anodised		86050	86060
	titanium anodised		86052	86062
<i>euro/m</i>				
TOP/TM/	bright satin titanium		86051	86061
<i>euro/m</i>				

individually packed

OUTSIDE CORNER - pack 2 pcs

ART.	finishing		90°	135°	90°	135°
ALUMINIUM						
TOP/E	silver anodised		86074	86072	86074	86072
	titanium anodised		86080	86082	86080	86082
<i>euro/pc</i>						
TOP/ETM	bright satin titanium		86075	86073	86075	86073
<i>euro/pc</i>						

INSIDE CORNER - pack 2 pcs

ART.	finishing		90°	135°	90°	135°
ALUMINIUM						
TOP/I	silver anodised		86078	86076	86078	86076
	titanium anodised		86081	86083	86081	86083
<i>euro/pc</i>						
TOP/ITM	bright satin titanium		86079	86077	86079	86077
<i>euro/pc</i>						

no partial packaging



TOP/A/10 + TOP/90/E + TOP/135/I silver anodised aluminium

Complete the article code with H measure
(for example TOP/A/ for H=10 becomes TOP/A/10)

For a single piece, see sales conditions on page 305



internal corners profiles

A line of profiles that fits the perimetric junction between floor and wall. Created for the elimination of 90° corners and applicable to installed or to be installed floors, ensure high hygienic efficiency in private and public environments such as hospitals, food industries, SPA, swimming pools and industrial kitchens.



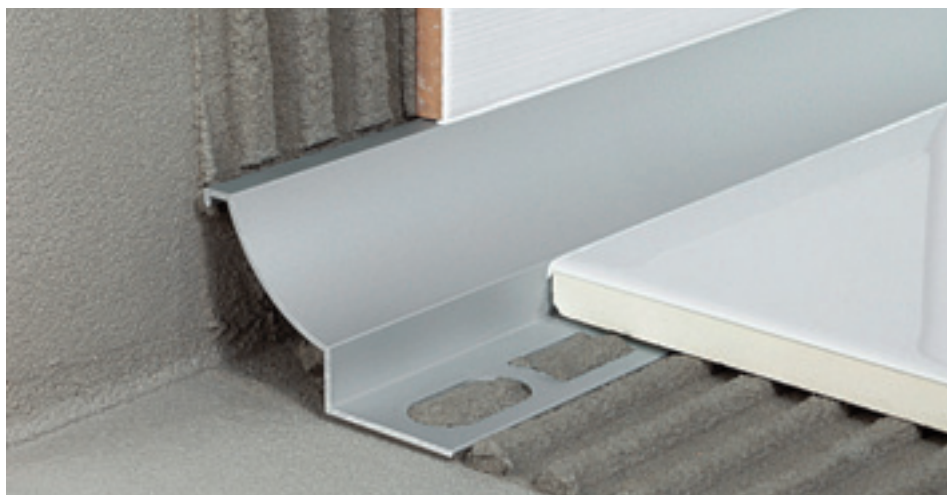

GA/10 silver anodised aluminium

Proround M in aluminum is a connection profile between floor and wall. The current requirements for sanitary maintenance required by European standards, provide in fact the elimination of the 90 ° to avoid any deposit of dirty and possible sources of bacteria, creating a curvature to facilitate cleaning.

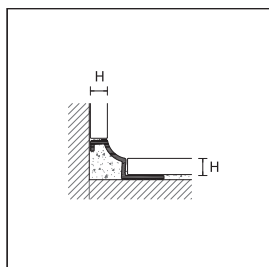

GA/4, GB/4

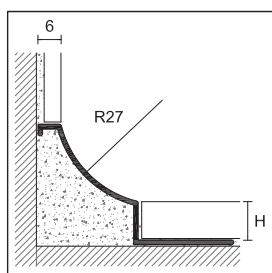

GA/8-10-12

Complete the article code with H measure (for example GA/ for H=8 becomes GA/8)

Items GV available in different colours on demand - minimum quantity 540 meters per colour.

* Out of production items, available till end of stock

For a single piece, see sales conditions on page 305

PROROUND M

length = 270 cm - pack 10 pcs

		H				
ART.	finishing	4,5	8	10	12	
ALUMINIUM						
GA/	silver anodised		95730	95031	95032	95033
	<i>euro/m</i>					
GB/	bright polished silver		95731 *	-	-	-
	<i>euro/m</i>					
GV/	colour-coated white RAL 9003		-	95071	95072	95073
	<i>euro/m</i>					

individually packed- GA/4 and GB/4 packaging 20 pcs

OUTSIDE CORNER

pack 5 pcs

		for all H		
ART.	finishing	4,5	8 - 10 - 12	
ALUMINIUM				
GTA/E	silver anodised		-	95075
	<i>euro/pc</i>			
GTV/E	colour-coated white RAL 9003		-	95083
	<i>euro/pc</i>			

INSIDE CORNER

pack 5 pcs

		for all H		
ART.	finishing	4,5	8 - 10 - 12	
ALUMINIUM				
GTA/I	silver anodised		-	95077
	<i>euro/pc</i>			
GTV/I	colour-coated white RAL 9003		-	95085
	<i>euro/pc</i>			

no partial packaging



GTA/E silver anodised aluminium



GTA/I silver anodised aluminium



GA/4 silver anodised aluminium



GIN/10 + ILN/10 polished stainless steel AISI 304 DIN 1.4301

Stainless steel Proround M is a connection profile to be used in situations that require a particular level of sanitary protection (eg, medical, food industry, swimming pools, spas, industrial kitchens, hospitals, etc.). Specifically, the version in quality AISI 316 DIN 1.4404 offers characteristics of superior resistance to corrosion and is therefore recommended for use in areas subjected to higher chemical attacks, and sea zones.

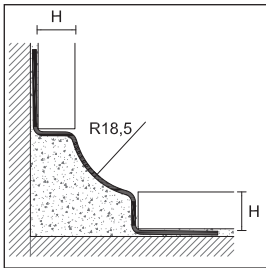

GIN 8/10/11

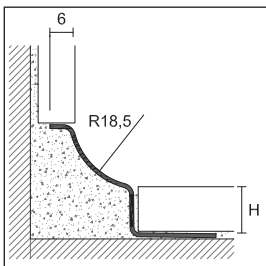

GIN 12/15

PROROUND M

length = 270 cm - pack 10 pcs

ART.	finishing	8	10	11	12,5	15
STAINLESS STEEL						
GIN/	polished stainless steel AISI 304 DIN 1.4301 euro/m	95046	95047	95045	95048	95049
GINS/	satin stainless steel AISI 304 DIN 1.4301 euro/m	95050	95051	95057	95052	-
GINX/	stainless steel AISI 316 DIN 1.4404 euro/m	95054	95055	-	95056	-

individually packed

pack 5 pcs		OUTSIDE CORNER-E for all H		INSIDE CORNER-I for all H	
ART.	finishing			ART.	
STAINLESS STEEL					
GTIN/E	polished stainless steel AISI 304 DIN 1.4301 euro/pc	95059		GTIN/I	95058
GTINS/E	satin stainless steel AISI 304 DIN 1.4301 euro/pc	95063		GTINS/I	95062
GTINX/E	stainless steel AISI 316 DIN 1.4404 euro/pc	95067		GTINX/I	95066

pack 5 pcs		TRIAxIAL CORNER-T for all H		JUNCTION-G for all H		END CAPS	
ART.	finishing			ART.		ART.	
GTIN/T	polished stainless steel AISI 304 DIN 1.4301 euro/pc	95060		GTIN/G	95061	GTIN/C	95040
GTINS/T	satin stainless steel AISI 304 DIN 1.4301 euro/pc	95064		GTINS/G	95065	GTINS/C	95041
GTINX/T	stainless steel AISI 316 DIN 1.4404 euro/pc	95068		GTINX/G	95069	GTINX/C	95042

no partial packaging

Complete the article code with H measure
(for example GIN/ for H=8 becomes GIN/8)

Cerfix® Proround M in stainless steel:
other measures on demand - minimum quantity 540 meters

For a single piece, see sales conditions on page 305



GIN/10 stainless steel AISI 304 DIN 1.4301



GIN/10 + ILN/10 stainless steel AISI 304 DIN 1.4301



stainless steel accessories for GIN/



GINI/10 polished stainless steel AISI 304 DIN 1.4301

Proround GINI/ is a perimetral connection profile in stainless steel used to connect floors and walls in places where a certain level of hygienic protection is required. Related items for corners, junctions and end caps are available.

Proround GIC/ is a connection profile in stainless steel, with a rounded shape, suitable for those places where a certain level of hygienic protection is required. The closed shape is particularly versatile thanks to the internal anchor flange.

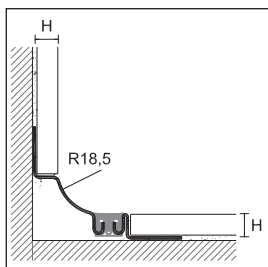

GINI/

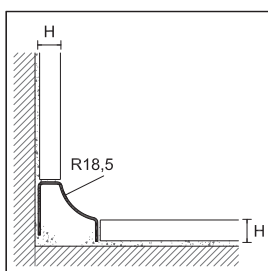

GIC/

PROROUND M

length = 270 cm - pack 5 pcs		H		
ART.	finishing	8	10	12,5
STAINLESS STEEL				
GINI/	polished stainless steel AISI 304 DIN 1.4301 + grey rubber <i>euro/m</i>	95130	95132	95134

PROROUND M

length = 270 cm - pack 5 pcs		8		
ART.	finishing			
STAINLESS STEEL				
GIC/	polished stainless steel AISI 304 DIN 1.4301 <i>euro/m</i>		95140	

pack 5 pcs		OUTSIDE CORNER-E	INSIDE CORNER-I	
		for all H	for all H	
ART.	finishing		ART.	
STAINLESS STEEL				
GTIN/E	polished stainless steel AISI 304 DIN 1.4301 <i>euro/pc</i>	95059	GTIN/I	95058

no partial packaging

Complete the article code with the height (E.G. GINI/ with H=8 becomes GINI/8)

We can create profiles Cerfix Proround GINI/ and GIC/ with sizes on request, for floors and coverings of different thickness. Contact our technical department for more informations

For a single piece, see sales conditions on page 305

pack 5 pcs		TRIAxIAL CORNER-T	JUNCTION-G	END CAPS	
		for all H	pack 5 pcs	for all H	
ART.	finishing		ART.	ART.	
GTIN/T	polished stainless steel AISI 304 DIN 1.4301 <i>euro/pc</i>	95060	GTIN/G	95061	GTIN/C 95040

no partial packaging



GIC/8 polished stainless steel AISI 304 DIN 1.4301



stainless steel accessories for GIC/

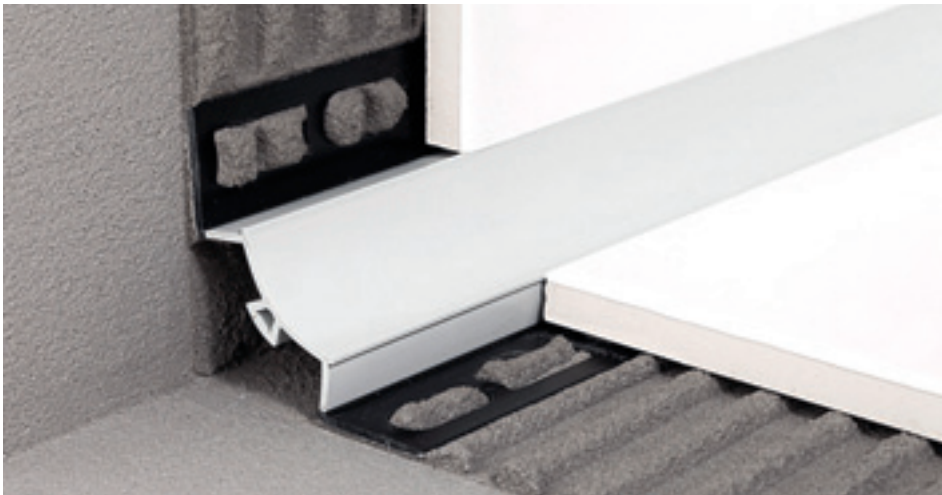

GP/10 white co-extruded PVC

Proround P in non-toxic PVC and impact resistant is a connection profile between floor and wall. The current requirements for sanitary maintenance required by European standards, provide in fact the elimination of the 90 ° to avoid any deposit of dirty and possible sources of bacteria, creating a curvature to facilitate cleaning. Models with a single anchor flange allow to be used as a connection between the laying floors and walls with different thickness.

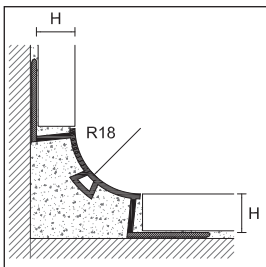

GP/

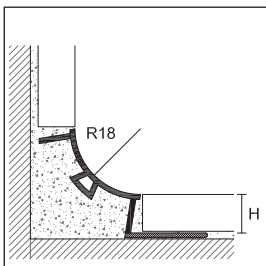

GPU/

PROROUND P

length = 270 cm - pack 20 pcs		H		H	
ART.		GP/		GPU/	
finishing		8	10	10	12,5
CO-EXTRUDED PVC					
white		95800	95801	95804	95803
light grey RAL 7035		95805	95806	-	-
stone grey RAL 7030		95810	95811	-	-
beige grey RAL 1019		95815	95816	-	-
euro/m					

INSIDE/OUTSIDE/TRIAXIAL CORNER/END CAP

pack 12 pcs		for all H			
ART.		GTP/E	GTP/I	GTP/T	GTP/C
finishing					
POLYPROPYLENE					
white		95852	95851	95850	95853
light grey RAL 7035		95862	95861	95860	95863
stone grey RAL 7030		95872	95871	95870	95873
beige grey RAL 1019		95882	95881	95880	95883
euro/pc					

no partial packaging

Complete the article code with H measure
(for example GP for H=8 becomes GP/8)

For a single piece, see sales conditions on page 305



GTP/E polypropylene RAL 7035 light grey



GTP/T polypropylene RAL 7035 light grey



accessories in polypropylene for GP/ and GPU



PIA/9 silver anodised aluminium



PIN/10 polished stainless steel AISI 304 DIN 1.4301

Proint PIA/, PI/ and PIN/ are a line of profiles in aluminium, stainless steel or PVC that are suitable for the perimetral connection during the laying of the wall covering and the floor or for the perimetral junction.

The application of Proint PIA PI and PIN allows to avoid the use of silicone for sealing and, in addition to the aesthetic advantage, it guarantees a high hygienic level over time.

The special sections of Proint facilitate the corner connection between the wall covering and the floor, thus guaranteeing the angular expansion between the two surfaces.

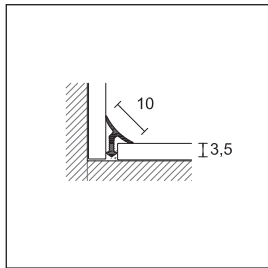

PIA/3

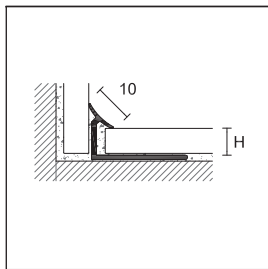

PIA/
PI/

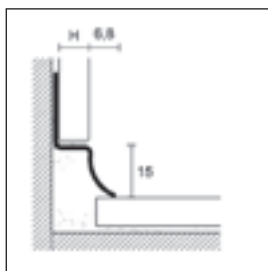

PIN/

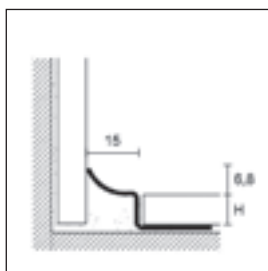

PIN/

Complete the article code with H measure (for example PIA for H=7 becomes PIA/7)

Items PI/ available in different colours and marbled on demand - minimum quantity 2700 meters per colour

For a single piece, see sales conditions on page 305

PROINT

length = 270 cm - pack 20 pcs

ART.	finishing	3,5	7	9	12
ALUMINIUM					
PIA/	silver anodised	95431	95430	95432	95429

individually packed

PROINT

length = 270 cm - pack 20 pcs

ART.	finishing	7	9
CO-EXTRUDED PVC			
	snow white	95396	95398
	white	95400	95402
	cream white RAL 9001	-	95406
	ivory RAL 1015	-	95418
PI/	beige grey RAL 1019	-	95410
	stone grey RAL 7030	-	95422
	ash grey RAL 7038	-	95433
	light grey RAL 7035	-	95414

pack 20 pcs
euro/m

pack 100 pcs
euro/m

no partial packaging - to order the pack of 100 pcs, mark /100 after article code

PROINT

length = 270 cm - pack 10 pcs

ART.	finishing	10	12,5
STAINLESS STEEL			
PIN/	polished stainless steel AISI 304 - DIN 1.4301	85392	85394

individually packed

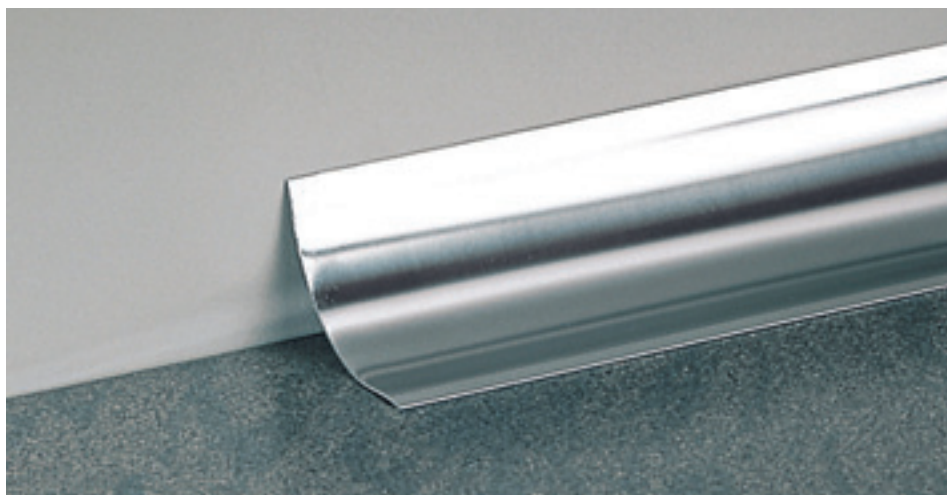

BI/40 stainless steel AISI 304 DIN 1.4301

Proround B, profiles available in stainless steel, aluminium and PVC, are perimetral connection profiles between floors and walls, suitable for those places where a certain level of hygienic protection is required. Proround B is the range specifically designed for application on surfaces already laying through the use of suitable adhesives; it is the optimal solution for the renovation and eventual respect in compliance with hygienic regulations. The stainless steel version (Model BI), is particularly resistant to attack by organic and inorganic agents, so it is suitable in environments such as hospitals, food and chemical industries. Special components are available to create junction, which act as external corners, internal corners, joints and end caps, providing a smooth and linear finishing.

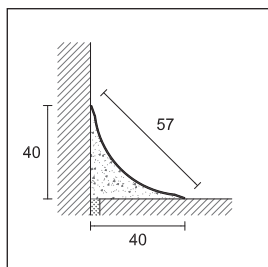

BI/40
BI/40/A

PROROUND B

length = 270 cm - pack 20 pcs		LxL
ART.	finishing	40x40
STAINLESS STEEL		
BI/40	stainless steel AISI 304 DIN 1.4301 euro/m	94992
BI/40/A adhesive	stainless steel AISI 304 DIN 1.4301 euro/m	94993



PI/9 pvc white

POLYPROPYLENE MATCHING CHROMIUM FINISH PACK 4 PCS		
OUTSIDE CORNER IN POLYPROPYLENE		
GTL/E	polypropylene chromium effect euro/pc	95515
INSIDE CORNER IN POLYPROPYLENE		
GTL/I	polypropylene chromium effect euro/pc	95517
TRIAXIAL CORNER IN POLYPROPYLENE		
GTL/T	polypropylene chromium effect euro/pc	95516
RIGHT-LEFT END CAPS IN POLYPROPYLENE		
GTL/C	polypropylene chromium effect euro/pc	95518

no partial packaging



PIA/3 silver anodised aluminium



accessories for BI/40 in polypropylene matching chromium finish

For a single piece, see sales conditions on page 305



BLA/20 silver anodised aluminium

Proround BLAH/ is a hygienic connection profile for the installation on already laid surfaces, through the use of specific adhesives. It is the best solution for refurbishments of places such as hospitals, food and chemical industries where bacteriostatic treatments are needed. Indeed, in addition to follow the ordinary requests of this kind of places, BLAH/ is provided with the certified antibacterial technology (according to the strict test internationally recognised JIS Z 2801:2000) which allows to reduce the presence of the most dangerous bacteria up until 99%, thus assuring the best hygienic level over time.

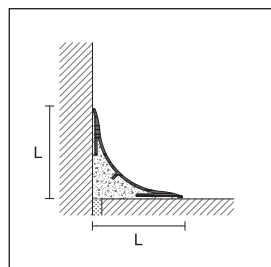











BLA/
BLAH/



BLAH/20 colour-coated white RAL 9003 antibacterial

PROROUND B

length = 270 cm - pack 20 pcs		LxL	
ART.	finishing	20x20	40x40
ALUMINIUM			
BLA/	silver anodised		95570
	euro/m		95580
ANTIBACTERIAL COLOUR-COATED ALUMINIUM			
BLAH/	colour-coated white RAL 9003 antibacterial		95572
	euro/m		95582
individually packed			
POLYPROPYLENE ACCESSORIES PACK		8 pcs	4 pcs
OUTSIDE CORNER IN POLYPROPYLENE			
	silver		95574
	euro/pc		95584
GBL/ E	white		95556
	euro/pc		95510
INSIDE CORNER IN POLYPROPYLENE			
	silver		95576
	euro/pc		95586
GBL/ I	white		95557
	euro/pc		95512
TRIAXIAL CORNER IN POLYPROPYLENE			
	silver		-
	euro/pc		95588
GBL/ T	white		-
	euro/pc		95511
RIGHT-LEFT END CAPS IN POLYPROPYLENE			
	silver		16 pcs
	euro/pc		8 pcs
GBL/ C	white		95578
	euro/pc		95590
	white		95558
	euro/pc		95513

Complete the article code with L measure
(for example BLA/ for L= 20 becomes BLA/20)

For a single piece, see sales conditions on page 305

no partial packaging - individually packed - article GBL/ /C pack of 16 pcs (20x20) and 8 pcs (40x40)

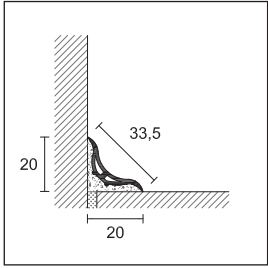

BL/20

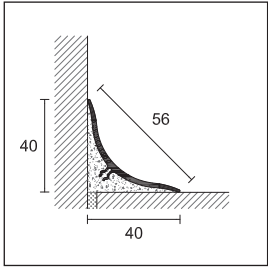

BL/40

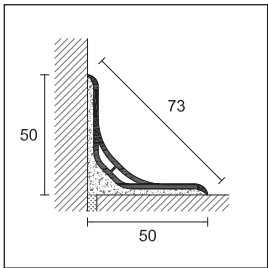

BL/50

PROROUND B

		length = 270 cm - pack 20 pcs			LxL		
ART.	finishing		20x20	40x40	50x50		
PVC							
BL/	white	<input type="checkbox"/>	95550	95500	95551		
			<i>euro/m</i>				

		POLYPROPYLENE ACCESSORIES PACK					
		8 pcs	4 pcs	4 pcs			
OUTSIDE CORNER IN WHITE POLYPROPYLENE							
GBL/ E	white	<input type="checkbox"/>	95556	95510	95552		
			<i>euro/pc</i>				
INSIDE CORNER IN WHITE POLYPROPYLENE							
GBL/ I	white	<input type="checkbox"/>	95557	95512	95553		
			<i>euro/pc</i>				
TRIAxIAL CORNER IN WHITE POLYPROPYLENE							
GBL/ T	white	<input type="checkbox"/>	-	95511	95554		
			<i>euro/pc</i>				
RIGHT-LEFT END CAPS IN WHITE POLYPROPYLENE							
GBL/ C	white	<input type="checkbox"/>	95558	95513	95555		
			<i>euro/pc</i>				

no partial packaging - Articles GBL/ C pack of 16 pcs (20x20) and 8 pcs (40x40 and 50x50)

For a single piece, see sales conditions on page 305



polypropylene accessories for BL/40



BL/50 co-extruded PVC





profiles and installation systems for bathrooms

Thin Drain, Slim Drain, Smart Drain and Q Drain are a range of shower drains and point drainages for flush with the floor showers.

Glass Profile is a line of profiles that cover the slope of 2% for the installation of the flush with the floor shower drains. They make the shower area aesthetically perfect and at one with the modern trends of interior design.



thin drain



thindrain

Thin Drain is a line of flush with the floor shower drains for a quick and easy installation, which allows to customize the shower with any kind of covering. Thanks to the syphon with low thickness and the height of the shower drain of just 55 mm, they are particularly suitable for refurbishments or in spaces where lightness and versatility are the main features.

ADVANTAGES

- Installation flush with the floor (it eliminates architectural barriers)
- Possibility of installation close to the wall
- Height of the shower drain of 55 mm (laying surface)
- Suitable for tiles with thickness up to 12 mm
- Possibility of laying tiles with thickness up to 12 mm with Tile Cover
- Shower drains with certification EN 1253-1 (minimum flow rate of 24 l/min)
- Supports for quick installation
- Integrated waterproof membrane to reduce the risk of seepages
- Possibility of inspection of the syphon for periodic cleaning
- Filter for cleaning/hair
- Quick installation
- Drain adapter from 4 to 50 mm included

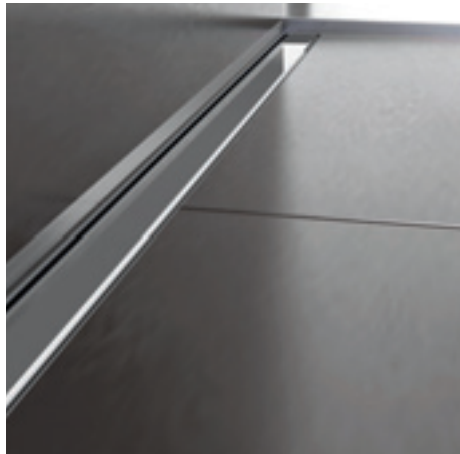

classic cover - polished stainless steel AISI 304 - DIN 1.4301

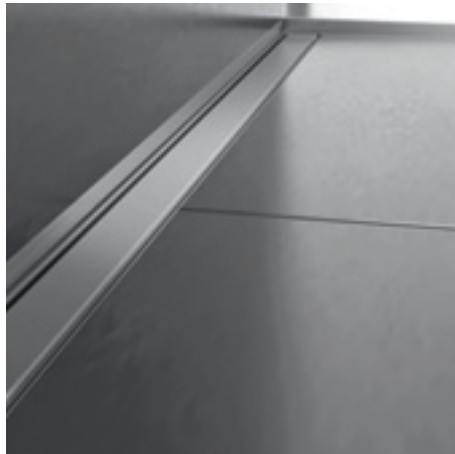

classic cover - satin stainless steel AISI 304 - DIN 1.4301

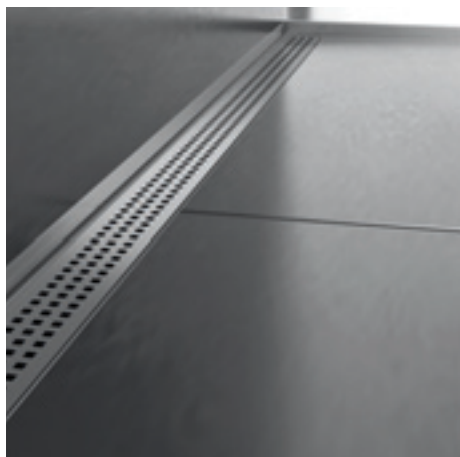

cube cover - satin stainless steel AISI 304 - DIN 1.4301

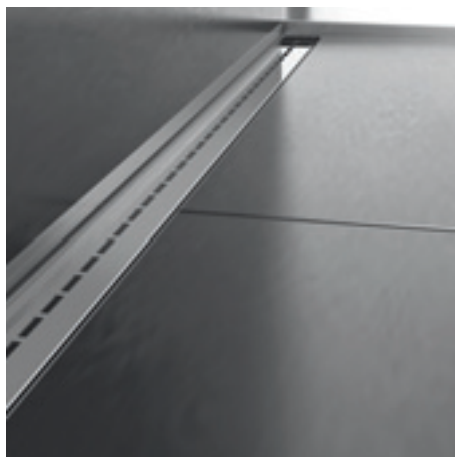

single line cover - polished stainless steel AISI 304 - DIN 1.4301



THIN DRAIN - BASE - pack 10 pcs

ART.	finishing	60 cm	70 cm	80 cm	90 cm	100 cm	120 cm
STAINLESS STEEL							
THIN/	stainless steel AISI 304 DIN 1.4301 euro/pc		19400	19401	19402	19403	19404 19405



CLASSIC COVER - pack 10 pcs

ART.	finishing	60 cm	70 cm	80 cm	90 cm	100 cm	120 cm
STAINLESS STEEL							
XTC/	satin stainless steel AISI 304 DIN 1.4301 polished stainless steel AISI 304 DIN 1.4301 euro/pc		19410	19412	19414	19416	19418 19420
			19411	19413	19415	19417	19419



CUBE COVER - pack 10 pcs

ART.	finishing	60 cm	70 cm	80 cm	90 cm
STAINLESS STEEL					
XTCC/	satin stainless steel AISI 304 DIN 1.4301 euro/pc		19430	19431	19432 19433



SINGLE LINE COVER - pack 10 pcs

ART.	finishing	60 cm	70 cm	80 cm	90 cm
XTL/	polished stainless steel AISI 304 DIN 1.4301 euro/pc		19440	19441	19442 19443



TILE COVER - pack 10 pcs

ART.	finishing	60 cm	70 cm	80 cm	90 cm
XTT/	stainless steel AISI 304 DIN 1.4301 euro/pc		19450	19451	19452 19453

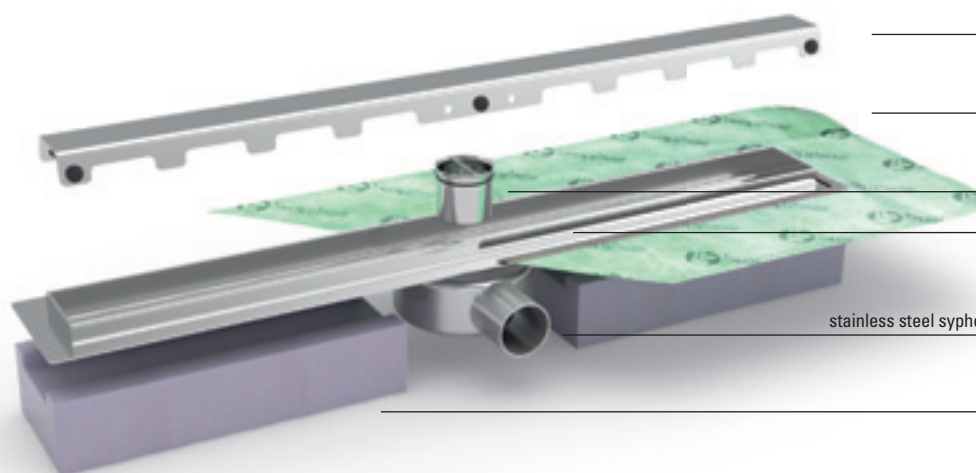

cover

pre-glued membrane

removable discharge cylinder for inspection

drain body

stainless steel syphon with reduced size - drain system height 55 mm

shaped base

10-years warranty

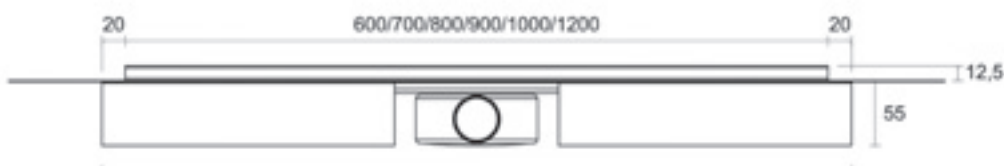
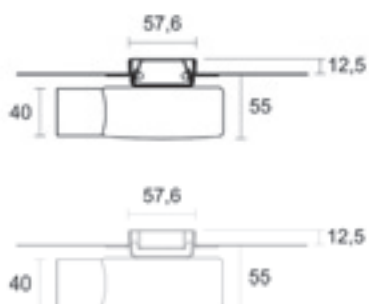

slim drain



slimdrain

Slim Drain is a line of flush with the floor shower drains for a quick and easy installation, which allows to customize the shower with any kind of covering and any tile thickness by choosing Slim Drain Invisible. Thanks to the syphon with low thickness and the height of the shower drain of just 65 mm, they are particularly suitable for refurbishments or in spaces where lightness and versatility are the main features.

ADVANTAGES

- Installation flush with the floor (it eliminates architectural barriers)
- Possibility of installation close to the wall
- Height of the shower drain of 65 mm (laying surface)
- Suitable for any tile thickness (Slim Invisible version)
- Adjustable frame (thickness 7-12,5 mm), Slim Invisible excluded.
- Shower drains with certification EN 1253-1 (minimum flow rate of 24 l/min)
- Integrated adjusting supports for an easy levelling
- Integrated waterproof membrane to reduce the risk of seepages
- Possibility of inspection of the syphon for periodic cleaning
- Filter for cleaning/hair
- Quick installation
- Drain adapter from 40 to 50 mm included

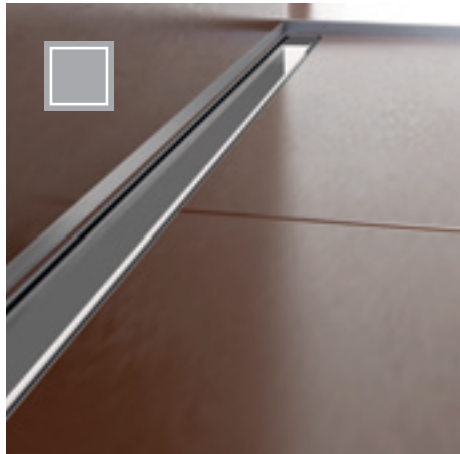

classic cover - polished stainless steel AISI 304 DIN 1.4301

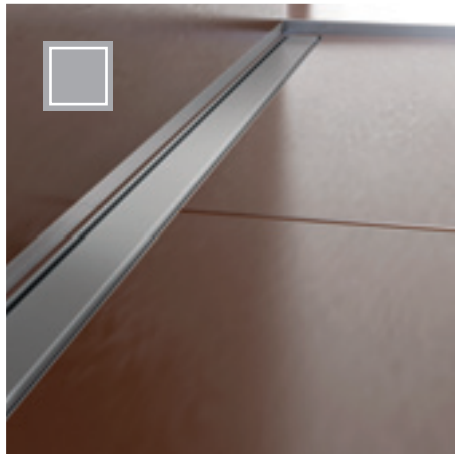

classic cover - satin stainless steel AISI 304 DIN 1.4301

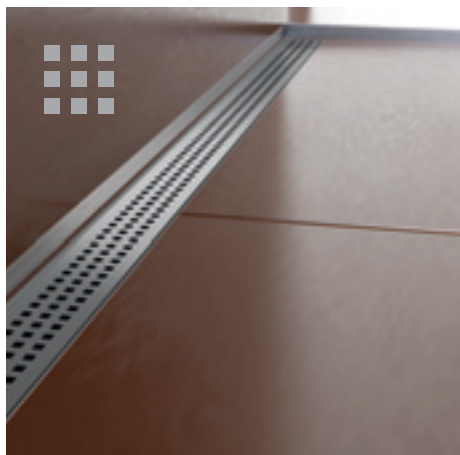

cube cover - satin stainless steel AISI 304 DIN 1.4301

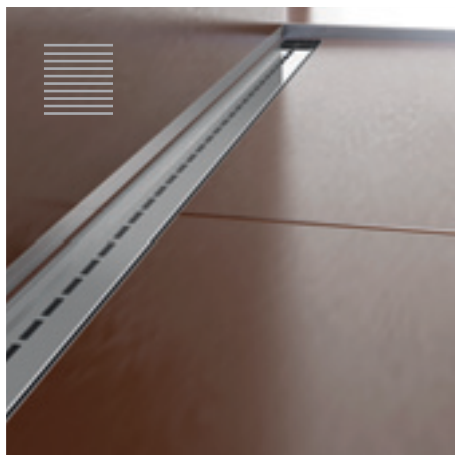

single line cover - polished stainless steel AISI 304 DIN 1.4301

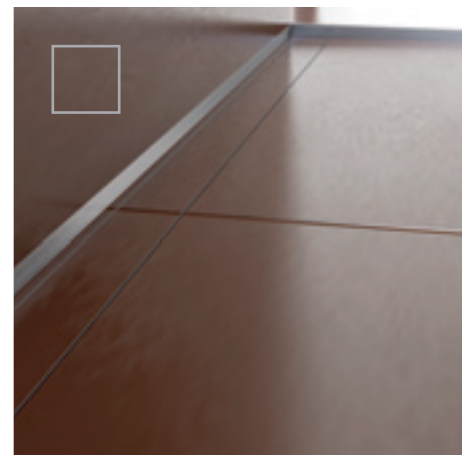



slim invisible - stainless steel AISI 304 DIN 1.4301

SLIM DRAIN - BASE - pack 10 pcs

ART.	finishing		60 cm	70 cm	80 cm	90 cm	100 cm	120 cm
STAINLESS STEEL								
SLIM/	stainless steel AISI 304 DIN 1.4301		19504	19506	19508	19510	19512	19514
	<i>euro/pc</i>							

CLASSIC COVER - pack 10 pcs

ART.	finishing		60 cm	70 cm	80 cm	90 cm	100 cm	120 cm
STAINLESS STEEL								
XSC/	satin stainless steel AISI 304 DIN 1.4301		19524	19526	19528	19530	19532	19534
	polished stainless steel AISI 304 DIN 1.4301		19523	19525	19527	19529	19531	19533
	<i>euro/pc</i>							

CUBE COVER - pack 10 pcs

ART.	finishing		60 cm	70 cm	80 cm	90 cm
STAINLESS STEEL						
XSCC/	satin stainless steel AISI 304 DIN 1.4301		19544	19546	19548	19550
	<i>euro/pc</i>					

SINGLE LINE COVER - pack 10 pcs

ART.	finishing		60 cm	70 cm	80 cm	90 cm
XSL/	polished stainless steel AISI 304 DIN 1.4301		19563	19565	19567	19569
	<i>euro/pc</i>					

SLIM INVISIBLE - BASE + COVER - pack 10 pcs

ART.	finishing		60 cm	70 cm	80 cm	90 cm
SLIM-I/	stainless steel AISI 304 DIN 1.4301		19505	19507	19509	19511
	<i>euro/pc</i>					

Slim Invisible does not include the adjustable frame

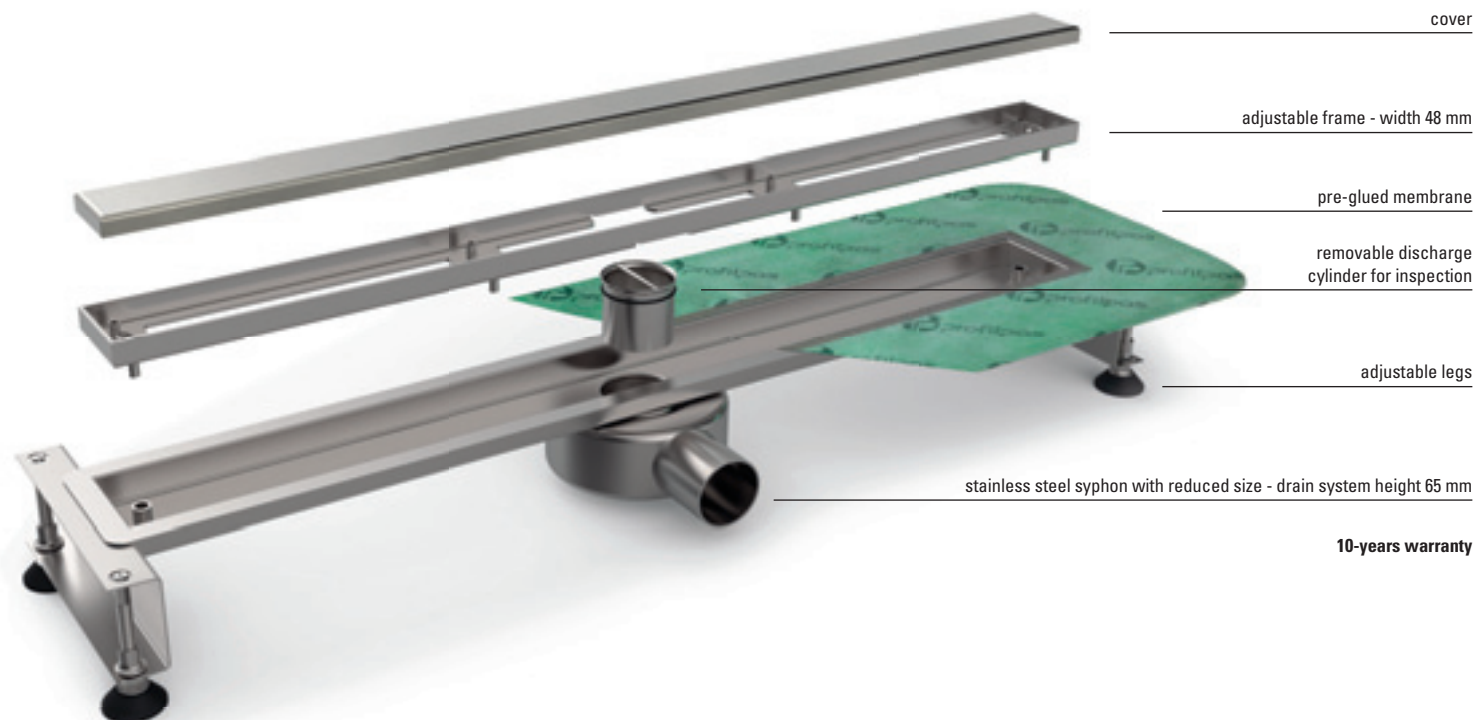
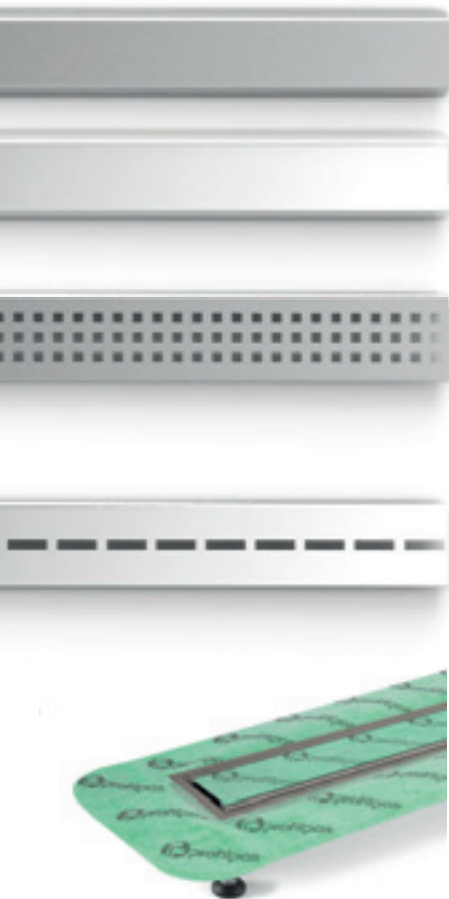

10-years warranty

smart drain



smartdrain

Smart Drain is a line of flush with the floor shower drains for a quick and easy installation, which allows to customize the shower with any kind of covering and any tile thickness by choosing Smart Drain Invisible. With high aesthetic level, varied sizes available and the height of the shower drain of 75 mm, they are particularly suitable for large size of tiles in every space.

ADVANTAGES

- Installation flush with the floor (it eliminates architectural barriers)
- Possibility of installation close to the wall
- Height of the shower drain of 75 mm (laying surface)
- Suitable for tiles with every tiles thickness (Smart Invisible version)
- Adjustable frame (thickness 7-12,5 mm), excluded Smart Invisible.
- Orientable siphoned body.
- Shower drains with certification EN 1253-1 (minimum flow rate of 24 l/min)
- Integrated regular supports for a simple set - aside at the same level.
- Integrated waterproof membrane to reduce the risk of seepages
- Suitable Inox stain steel AISI 316 - DIN 14404 version
- 180° Ruotatable classic cover for tiles (maximum thickness 10 mm)
- Possibility of inspection of the syphon for periodic cleaning
- Filter for cleaning/hair
- Quick installation



classic cover - polished stainless steel AISI 304 DIN 1.4301



classic cover - satin stainless steel AISI 304 DIN 1.4301



cube cover - satin stainless steel AISI 304 DIN 1.4301





double line cover - polished stainless steel AISI 304 DIN 1.4301





smart invisible - stainless steel AISI 304 DIN 1.4301

SMART DRAIN - BASE - pack 10 pcs

ART.	finishing		70 cm	80 cm	90 cm	100 cm	110 cm	120 cm
STAINLESS STEEL								
SMART/	stainless steel AISI 304 DIN 1.4301 <i>euro/pc</i>		19704	19706	19708	19710	19712	19714
SMART3/	stainless steel AISI 316 DIN 1.4404 <i>euro/pc</i>		19715	19716	19717	19718	-	-

CLASSIC COVER - pack 10 pcs

ART.	finishing		70 cm	80 cm	90 cm	100 cm	110 cm	120 cm
STAINLESS STEEL								
XLC/	satin stainless steel AISI 304 DIN 1.4301		19724	19726	19728	19730	19732	19734
	polished stainless steel AISI 304 DIN 1.4301 <i>euro/pc</i>		19723	19725	19727	19729	19731	19733
XLC3/	satin stainless steel AISI 316 DIN 1.4404 <i>euro/pc</i>		19741	19742	19743	19744	-	-

CUBE COVER - pack 10 pcs

ART.	finishing		70 cm	80 cm	90 cm	100 cm	110 cm	120 cm
STAINLESS STEEL								
XLCC/	satin stainless steel AISI 304 DIN 1.4301 <i>euro/pc</i>		19764	19766	19768	19770	19772	19774

DOUBLE LINE COVER - pack 10 pcs

ART.	finishing		70 cm	80 cm	90 cm	100 cm	110 cm	120 cm
STAINLESS STEEL								
XLL/	polished stainless steel AISI 304 DIN 1.4301 <i>euro/pc</i>		19783	19785	19787	19789	19791	19793

SMART INVISIBLE - BASE + COVER - pack 10 pcs

ART.	finishing		70 cm	80 cm	90 cm	100 cm	110 cm	120 cm
STAINLESS STEEL								
SMART-I/	stainless steel AISI 304 DIN 1.4301 <i>euro/pc</i>		19703	19705	19707	19709	19711	19713

Smart Invisible does not include the adjustable frame

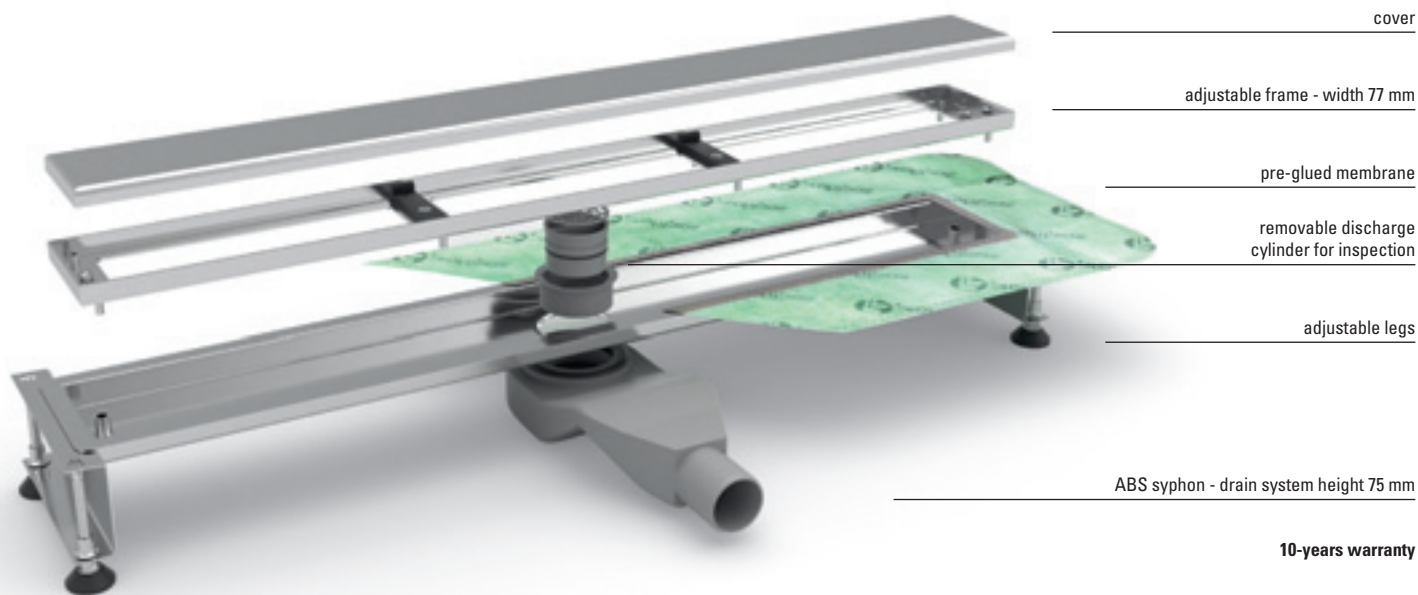

cover

adjustable frame - width 77 mm

pre-glued membrane

removable discharge cylinder for inspection

adjustable legs

ABS syphon - drain system height 75 mm

10-years warranty



q-drain

Q-Drain is a line of point drainages for flush with the floor showers which are quick and easy to install and allow to customize the shower with any kind of covering. Provided with insulating flange and with a height of 72/78 mm, they are the ideal solution for traditional showers flush with the floor.

ADVANTAGES

- Installation flush with the floor (it eliminates architectural barriers)
- Height of the point drainage of 72/78 mm (laying surface)
- Directable syphon
- Shower drains with certification EN 1253-1 (minimum flow rate of 24 l/min)
- Integrated waterproof membrane to reduce the risk of seepages
- Possibility of laying tiles with thickness up to 10 mm with Q Drain Tile
- Possibility of inspection of the syphon for periodic cleaning
- Filter for cleaning/hair
- Quick installation





Q Drain Cube



Q Drain Line





Q DRAIN CLASSIC - pack 10 pcs

ART.	finishing		10x10 cm
STAINLESS STEEL			floor thickness of 12,5 mm
QDC/1010	satin stainless steel AISI 304 DIN 1.4301		19850
	polished stainless steel AISI 304 DIN 1.4301		19851
<i>euro/pc</i>			





Q DRAIN CUBE - pack 10 pcs

ART.	finishing		10x10 cm
STAINLESS STEEL			floor thickness of 12,5 mm
QDCC/1010	satin stainless steel AISI 304 DIN 1.4301		19852
	polished stainless steel AISI 304 DIN 1.4301		19853
<i>euro/pc</i>			



Q DRAIN LINE - pack 10 pcs

ART.	finishing		10x10 cm
STAINLESS STEEL			floor thickness of 12,5 mm
QDL/1010	satin stainless steel AISI 304 DIN 1.4301		19854
	polished stainless steel AISI 304 DIN 1.4301		19855
<i>euro/pc</i>			

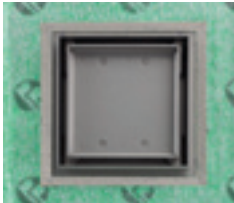

Q DRAIN TILE - pack 10 pcs

ART.	finishing		10x10 cm
STAINLESS STEEL			floor thickness of 10 mm
QDI/1010	stainless steel AISI 304 DIN 1.4301		19856
<i>euro/pc</i>			

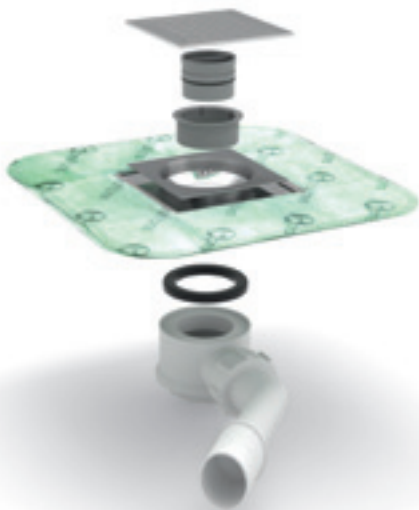

10-years warranty

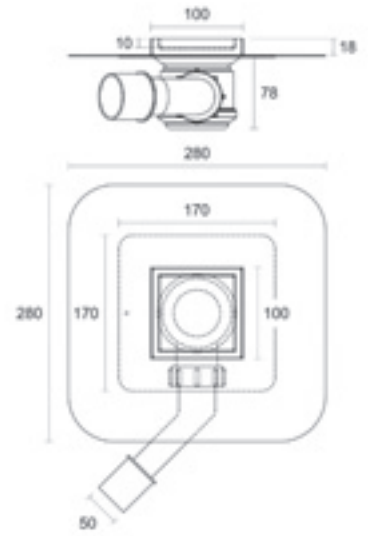
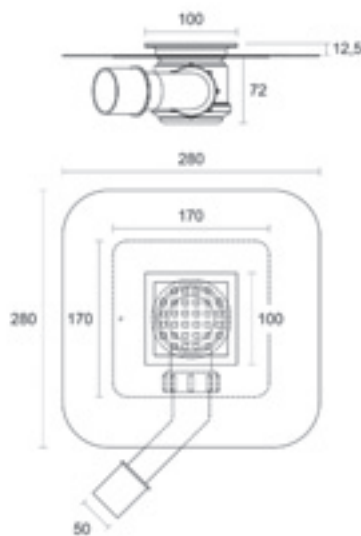

slim drain - smart drain

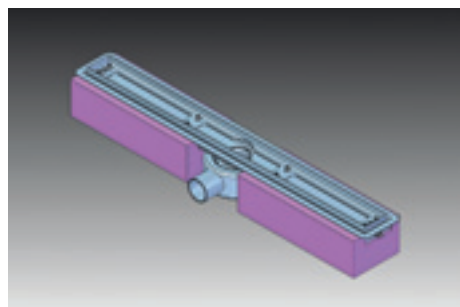

SLIM/BD01 + SLIM/

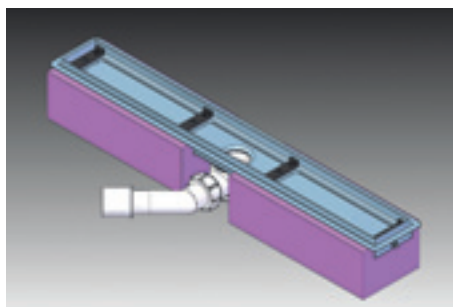

SMART/BD01 + SMART/

SLIM/BD01 and SMART/BD01 are two shaped bases in extruded polystyrene, that are highly resistant and low-absorbent, specifically designed for the laying of the shower drains SLIM DRAIN and SMART DRAIN. You just need to set the drain system (of every size) on the specific base, use a spirit level and fix it with the adhesive in order to proceed rapidly with the application of the leveling screed or with the positioning of the panel with slope.

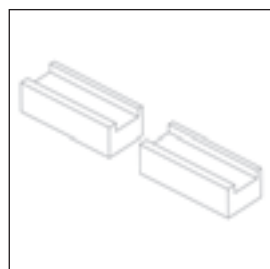

SLIM/BD01
SMART/BD01

SLIM DRAIN

bases for Slim Drain - pack 1 pc

ART.

EXTRUDED POLYSTYRENE

SLIM/BD01 dimensions cm 25 + 25 x 10 x 7 H

19600 *

euro/pc

individually packed

SMART DRAIN

bases for Smart Drain - pack 1 pc

ART.

EXTRUDED POLYSTYRENE

SMART/BD01 dimensions cm 30 + 30 x 12 x 9 H

19602 *

euro/pc

individually packed

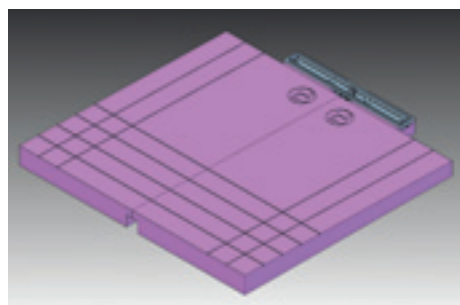

SLIM/P + SLIM/

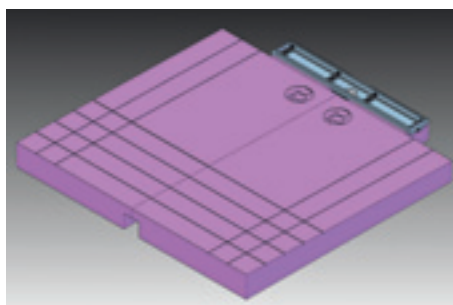

SMART/P + SMART/

SLIM/P and SMART/P are panels with a 2% slope in extruded polystyrene, that are highly resistant and low absorbent, specifically designed for the realization of flush-with-the-floor showers. The two panels are composed of 2 parts and, together with SLIM DRAIN and SMART DRAIN, they allow the rapid implementation of the slope laying panel. The panels are suitable for all sizes of drains and they can be easily cut to order with a simple cutter along the pre-cut cutting lines.

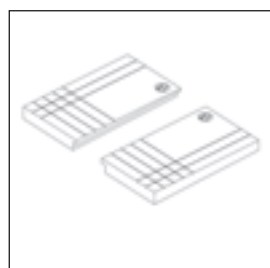

SLIM/P
SMART/P

SLIM DRAIN

panel with slope for Slim Drain - pack 1 pc

ART.

EXTRUDED POLYSTYRENE

SLIM/P dimensions cm 60 + 60 x 110 x 9 H

19610 *

euro/pc

individually packed

SMART DRAIN

panel with slope for Smart Drain - pack 1 pc

ART.

EXTRUDED POLYSTYRENE

SMART/P dimensions cm 60 + 60 x 108 x 11 H

19612 *

euro/pc

individually packed

* Out of production items, available till end of stock

For a single piece, see sales conditions on page 305

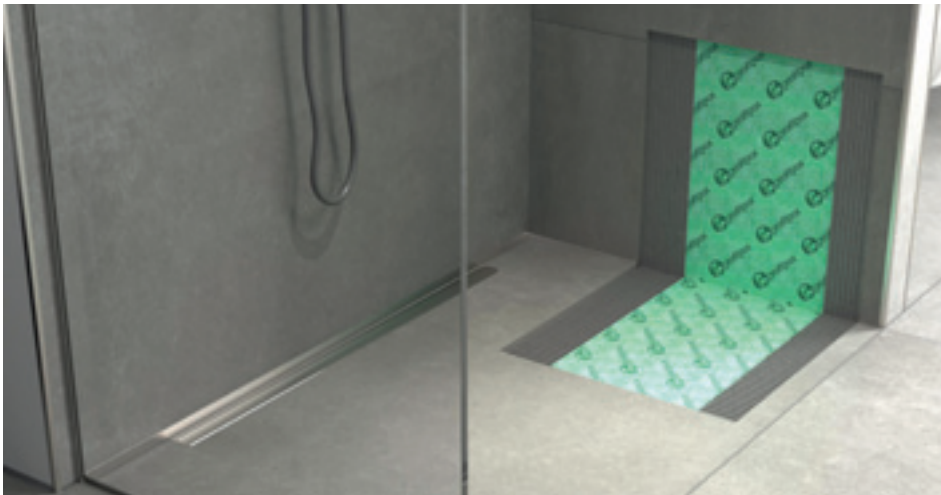

Wpstop system

Wpstop is a waterproof membrane in polyethylene with a textile in polypropylene in both sides in order to facilitate the grip of the adhesive, thus ensuring a high adhesion to the support. It is particularly suitable for the waterproofing of floors and tiled walls of bathrooms. For the application, we recommend the use of tiles adhesive C2, while in the joints between sheets and accessories we recommend the use of a polymer sealant MS (type PP/96).



rotoli



bande

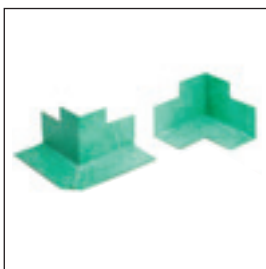

angoli

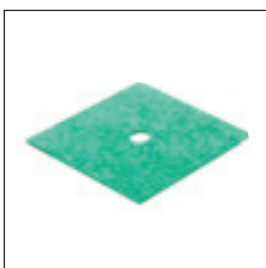

collarino

WPSTOP

ART. measures

PR30 roll 1 m height 30 mt length - pack 1 roll 19900

euro/m

PR5 roll 1 m height 5 mt length - pack 6 rolls 19902

euro/m

PB30 stripe 14 cm height 30 mt length - pack 1 roll 19910

euro/m

PB5 stripe 14 cm height 5 mt length - pack 6 rolls 19912

euro/m

PAE outside corner - pack 10 pcs 19920

euro/pc

PAI inside corner - pack 10 pcs 19922

euro/pc

PF12 colar cm 12x12 - pack 10 pcs 19930

euro/pc

no partial packaging

INSTRUCTIONS

Store in a cool and dry place, avoiding direct exposure to sunlight and heat sources.

Please refer to the technical data sheet before the installation. For special installations, please contact our technical department.

glass profile



Glass Profile

Glass Profile is a line of stainless steel profiles for the creation of floor-level shower surfaces. Glass Profile creates a coplanar surface characterized by a modern and linear design, by covering the difference in height of the surface with 2% slope. The use of stainless steel guarantees an excellent duration over time and a high aesthetic and functional value of the product.



GPS1/DX/19 + GPS1/SX/19 + GPS5/23



GPS1/SX/19 + GPS4/DX/10 + GPS5/23

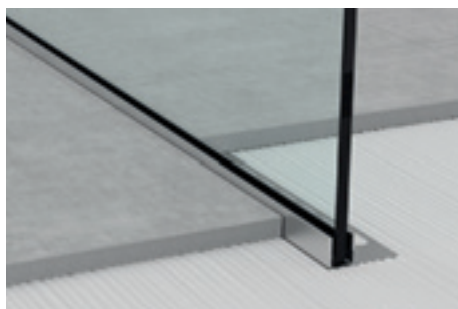

GPS1/DX/19 satin stainless steel AISI 304 DIN 1.4301

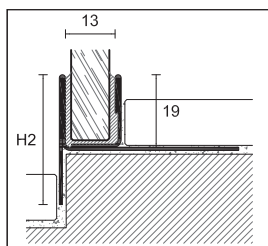

GPS1/DX/19

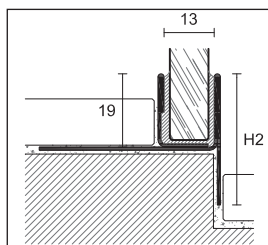

GPS1/SX/19

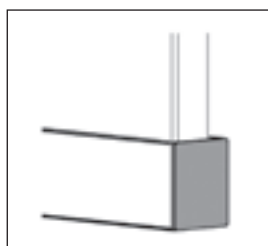

GPS/6

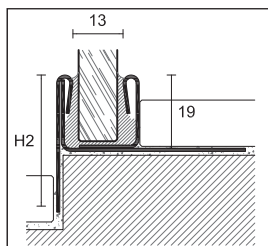

GPS7/DX/19

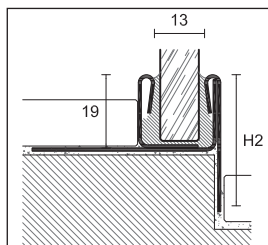

GPS7/SX/19

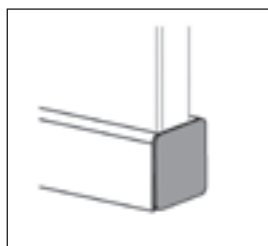

GPS/15

Glass Profile GPS1/ is a stainless steel profile for the insertion of glass walls of floor-level showers with Thin Drain, Slim Drain and Smart Drain.

GPS1/ is provided with a 2% slope on the shower inner side for a perfect aesthetic solution of the sloped surface.

On completion of the profile, there is GPS/6, the end cap for hiding the section of the glass wall.

GLASS PROFILE

pack 5 pcs

ART. GPS1/ /19

STAINLESS STEEL

	RH	LH	RH	LH	RH	LH	RH	LH
length cm	98		120		148		200	
H2 mm	34		37		42		60	
satin stainless steel AISI 304 DIN 1.4301		31505 31507		31515 31517		31525 31527		31535 31537
euro/pc								

individually packed - Article GPS1/ is not available for the markets of Germany, Austria and Switzerland

GLASS PROFILE

end cap - pack 5 pcs

ART. finishing

STAINLESS STEEL

GPS/6	satin stainless steel AISI 304 DIN 1.4301		31564
	euro/pc		

no partial packaging

Glass Profile GPS7/ /19 is a stainless steel profile for the insertion of glass walls of floor-level showers with Thin Drain, Slim Drain or Smart Drain.

GPS7/ /19 is provided with a 2% slope on the shower inner side for a perfect aesthetic solution of the sloped surface.

On completion of the profile, there is GPS/15, the end cap for hiding the section of the glass wall.

GLASS PROFILE

pack 5 pcs

ART. GPS7/ /19

STAINLESS STEEL

	RH	LH	RH	LH	RH	LH	RH	LH
length cm	98		120		148		200	
H2 mm	34		37		42		60	
satin stainless steel AISI 304 DIN 1.4301		31805 31807		31815 31817		31825 31827		31835 31837
euro/pc								

individually packed - GPS7/ /19 is also available for the markets of Germany, Austria and Switzerland

GLASS PROFILE

end cap - pack 5 pcs

ART. finishing

STAINLESS STEEL

GPS/15	satin stainless steel AISI 304 DIN 1.4301		31565
	euro/pc		

no partial packaging - end cap for GPS7/ /19

Complete the article code with DX and SX (DX = RH and SX = LH) - for example GPS1/ /19 RH becomes GPS1/DX/19
For a single piece, see sales conditions on page 305

glass profile



GPS2/19 satin stainless steel AISI 304 DIN 1.4301

Glass Profile GPS2/ is a stainless steel profile for the insertion of glass walls on the wall covering of floor-level showers with Thin Drain, Slim Drain or Smart Drain. It is easy to install, is suitable for tiles of any thickness and does not need drillings. On completion of the profile, there is GPS/6, the end cap for hiding the section of the glass wall.

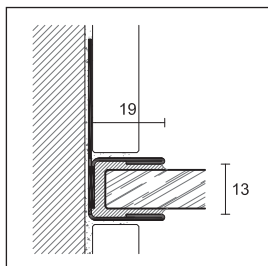

GPS2/19

GLASS PROFILE

pack 5 pcs

ART. **GPS2/19**

STAINLESS STEEL

length cm	210	250
satin stainless steel AISI 304 DIN 1.4301		31543

euro/pc

individually packed

GLASS PROFILE

end cap - pack 5 pcs

ART. **finishing**

STAINLESS STEEL

GPS/6	satin stainless steel AISI 304 DIN 1.4301		31564
-------	---	--	-------

euro/pc

no partial packaging - end cap for GPS1/ /19 and GPS2/19

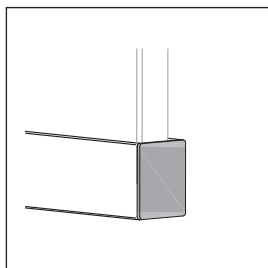

GPS/6



GPS14/12 satin stainless steel AISI 304 DIN 1.4301

Glass Profile GPS14/ is a stainless steel profile suitable for the insertion of glass walls on the wall covering. This profile can be directly installed on wall coverings already laid. The silicone seals of different sizes complete the Glass Profile range and can be used inside the profiles to keep the glass stable.

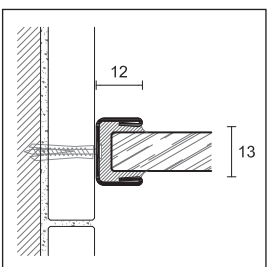

GPS14/12

GLASS PROFILE

pack 5 pcs

ART. **GPS14/12**

STAINLESS STEEL

length cm	210	250
satin stainless steel AISI 304 DIN 1.4301		32000

euro/pc

individually packed

SILICONE SEALS

pack 5 mt

ART. **measures**

GG/2 thickness 2 mm 31590

euro/pack

GG/3 thickness 3 mm 31592

euro/pack

GG/4 thickness 4 mm 31594

euro/pack

no partial packaging



silicone seals

For a single piece, see sales conditions on page 305

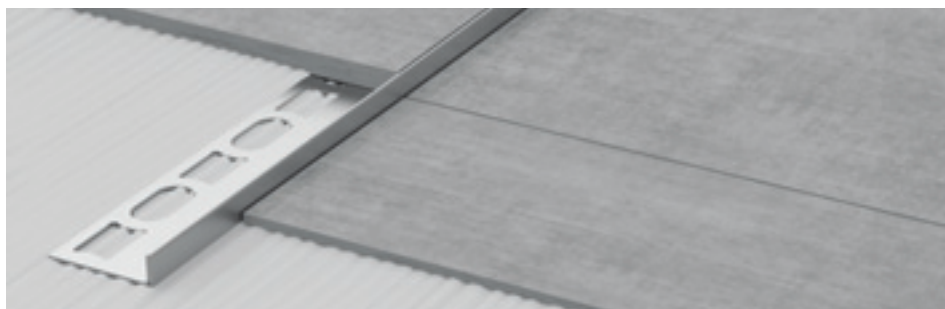

GPS3/SX/10 satin stainless steel AISI 304 DIN 1.4301

Glass Profile GPS3/ is a stainless steel profile provided with a 2% slope on the shower inner side for a perfect aesthetic solution of the sides of the sloped surface.

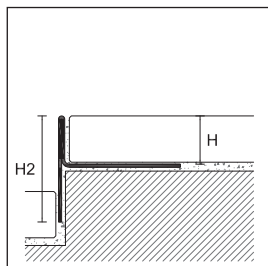

GPS3/DX/

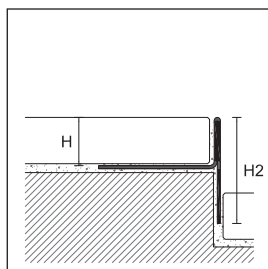



GPS3/SX/

GLASS PROFILE

length = 98 cm - pack 5 pcs

ART. finishing

STAINLESS STEEL

		H	H2	RH	LH
GPS3/10	satin stainless steel AISI 304 DIN 1.4301 <i>euro/pc</i>	 10	25	31615	31617
GPS3/12	satin stainless steel AISI 304 DIN 1.4301 <i>euro/pc</i>	 12,5	27,5	31625	31627



individually packed - Article GPS3/ is not available for the markets of Germany, Austria and Switzerland

GLASS PROFILE

length = 120 cm - pack 5 pcs

ART. finishing

STAINLESS STEEL

		H	H2	RH	LH
GPS3/10	satin stainless steel AISI 304 DIN 1.4301 <i>euro/pc</i>	 10	28	31645	31647
GPS3/12	satin stainless steel AISI 304 DIN 1.4301 <i>euro/pc</i>	 12,5	30,5	31655	31657



individually packed - Article GPS3/ is not available for the markets of Germany, Austria and Switzerland

GLASS PROFILE

length = 148 cm - pack 5 pcs

ART. finishing

STAINLESS STEEL

		H	H2	RH	LH
GPS3/10	satin stainless steel AISI 304 DIN 1.4301 <i>euro/pc</i>	 10	33	31675	31677
GPS3/12	satin stainless steel AISI 304 DIN 1.4301 <i>euro/pc</i>	 12,5	35,5	31685	31687



individually packed - Article GPS3/ is not available for the markets of Germany, Austria and Switzerland

GLASS PROFILE

length = 200 cm - pack 5 pcs

ART. finishing

STAINLESS STEEL

		H	H2	RH	LH
GPS3/10	satin stainless steel AISI 304 DIN 1.4301 <i>euro/pc</i>	 10	51	31694	31695
GPS3/12	satin stainless steel AISI 304 DIN 1.4301 <i>euro/pc</i>	 12,5	53,5	31698	31699

individually packed - Article GPS3/ is not available for the markets of Germany, Austria and Switzerland

Complete the article code with DX and SX (DX = RH and SX = LH) - for example GPS3//10 RH becomes GPS3/DX/10)

For a single piece, see sales conditions on page 305

glass profile

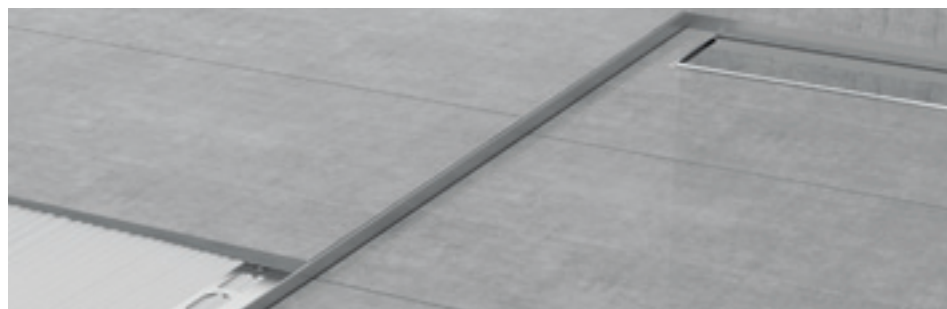

GPS8/SX/10 satin stainless steel AISI 304 DIN 1.4301

Glass Profile GPS8/ is a modular stainless steel profile provided with a 2% slope on the shower inner side for a perfect aesthetic solution of the sides of the sloped surface.

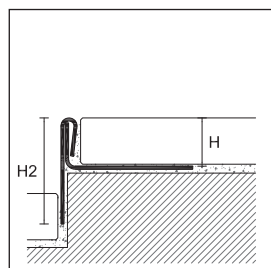

GPS8/DX/

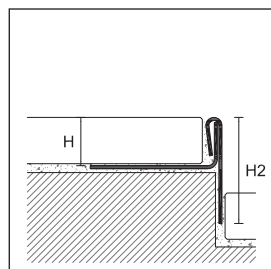

GPS8/SX/

GLASS PROFILE

length = 98 cm - pack 5 pcs

ART. finishing

STAINLESS STEEL

		H	H2	RH	LH
GPS8//8	satin stainless steel AISI 304 DIN 1.4301 <i>euro/pc</i>	8	23	31905	31907
GPS8//10	satin stainless steel AISI 304 DIN 1.4301 <i>euro/pc</i>	10	25	31915	31917
GPS8//12	satin stainless steel AISI 304 DIN 1.4301 <i>euro/pc</i>	12,5	27,5	31925	31927

individually packed - GPS8/ is also available for the markets of Germany, Austria and Switzerland

GLASS PROFILE

length = 120 cm - pack 5 pcs

ART. finishing

STAINLESS STEEL

		H	H2	RH	LH
GPS8//8	satin stainless steel AISI 304 DIN 1.4301 <i>euro/pc</i>	8	26	31935	31937
GPS8//10	satin stainless steel AISI 304 DIN 1.4301 <i>euro/pc</i>	10	28	31945	31947
GPS8//12	satin stainless steel AISI 304 DIN 1.4301 <i>euro/pc</i>	12,5	30,5	31955	31957

individually packed - GPS8/ is also available for the markets of Germany, Austria and Switzerland

GLASS PROFILE

length = 148 cm - pack 5 pcs

ART. finishing

STAINLESS STEEL

		H	H2	RH	LH
GPS8//8	satin stainless steel AISI 304 DIN 1.4301 <i>euro/pc</i>	8	31	31965	31967
GPS8//10	satin stainless steel AISI 304 DIN 1.4301 <i>euro/pc</i>	10	33	31975	31977
GPS8//12	satin stainless steel AISI 304 DIN 1.4301 <i>euro/pc</i>	12,5	35,5	31985	31987

individually packed - GPS8/ is also available for the markets of Germany, Austria and Switzerland

GLASS PROFILE

length = 200 cm - pack 5 pcs

ART. finishing

STAINLESS STEEL

		H	H2	RH	LH
GPS8//8	satin stainless steel AISI 304 DIN 1.4301 <i>euro/pc</i>	8	49	31990	31991
GPS8//10	satin stainless steel AISI 304 DIN 1.4301 <i>euro/pc</i>	10	51	31994	31995
GPS8//12	satin stainless steel AISI 304 DIN 1.4301 <i>euro/pc</i>	12,5	53,5	31998	31999

individually packed - l'art. GPS8/ is also available for the markets of Germany, Austria and Switzerland

Complete the article code with DX and SX
(DX = RH and SX = LH) - for example GPS8//8 RH becomes
GPS8/RH/8)

For a single piece, see sales conditions on page 305

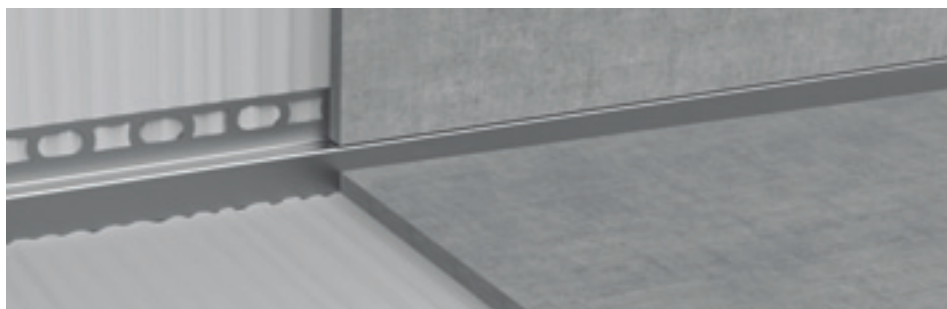

GPS4/SX/10 satin stainless steel AISI 304 DIN 1.4301

Glass Profile GPS4/ is a stainless steel profile provided with a 2% slope on the shower inner side. It connects the sloped floor and the covering perfectly, thus avoiding the oblique cut of the tiles.

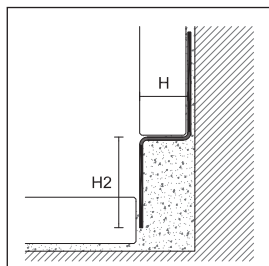

GPS4/DX/

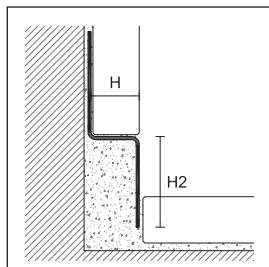

GPS4/SX/

GLASS PROFILE

length = 98 cm - pack 5 pcs

ART. finishing

STAINLESS STEEL

		H	H2	RH	LH
GPS4/8	satin stainless steel AISI 304 DIN 1.4301 euro/pc	8	23	31705	31707
GPS4/10	satin stainless steel AISI 304 DIN 1.4301 euro/pc	10	23	31715	31717
GPS4/12	satin stainless steel AISI 304 DIN 1.4301 euro/pc	12,5	23	31725	31727

individually packed

GLASS PROFILE

length = 120 cm - pack 5 pcs

ART. finishing

STAINLESS STEEL

		H	H2	RH	LH
GPS4/8	satin stainless steel AISI 304 DIN 1.4301 euro/pc	8	26	31735	31737
GPS4/10	satin stainless steel AISI 304 DIN 1.4301 euro/pc	10	26	31745	31747
GPS4/12	satin stainless steel AISI 304 DIN 1.4301 euro/pc	12,5	26	31755	31757

individually packed

GLASS PROFILE

length = 148 cm - pack 5 pcs

ART. finishing

STAINLESS STEEL

		H	H2	RH	LH
GPS4/8	satin stainless steel AISI 304 DIN 1.4301 euro/pc	8	31	31765	31767
GPS4/10	satin stainless steel AISI 304 DIN 1.4301 euro/pc	10	31	31775	31777
GPS4/12	satin stainless steel AISI 304 DIN 1.4301 euro/pc	12,5	31	31785	31787

individually packed

GLASS PROFILE

length = 200 cm - pack 5 pcs

ART. finishing

STAINLESS STEEL

		H	H2	RH	LH
GPS4/8	satin stainless steel AISI 304 DIN 1.4301 euro/pc	8	49	31790	31791
GPS4/10	satin stainless steel AISI 304 DIN 1.4301 euro/pc	10	49	31794	31795
GPS4/12	satin stainless steel AISI 304 DIN 1.4301 euro/pc	12,5	49	31798	31799

individually packed

Complete the article code with DX and SX (DX = RH and SX = LH) - for example GPS4/8 RH becomes GPS4/RH/8)

For a single piece, see sales conditions on page 305

glass profile



Glass Profile GPS5/ is a stainless steel profile to be positioned on the wall covering, above the shower drain with sloped surface, in order to avoid the cut of the tiles.

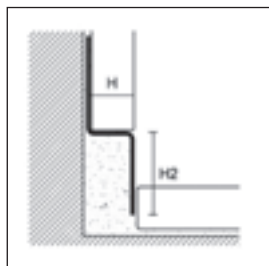

GPS5/ satin stainless steel AISI 304 DIN 1.4301



GPS5/

GLASS PROFILE

length = 125 cm - pack 5 pcs

		H2			
ART.	finishing	23	33	45	
STAINLESS STEEL		H			
GPS5/10/	satin stainless steel AISI 304 DIN 1.4301 <i>euro/pc</i>	 10	31551	31553	31559
GPS5/12/	satin stainless steel AISI 304 DIN 1.4301 <i>euro/pc</i>	 12,5	31555	31557	31561

individually packed



GPS1/DX/19 satin stainless steel AISI 304 DIN 1.4301



GPS2/19 satin stainless steel AISI 304 DIN 1.4301

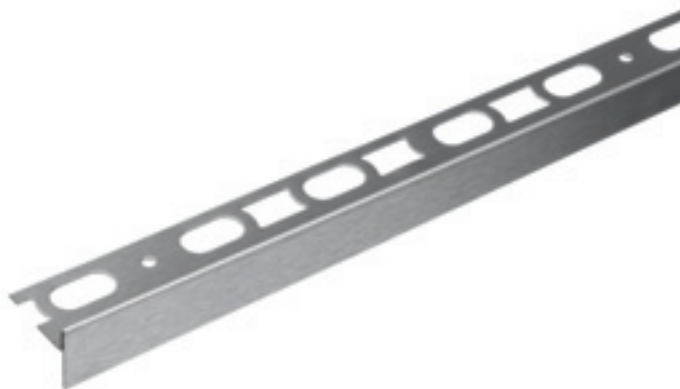

GPS3/DX/10 satin stainless steel AISI 304 DIN 1.4301



GPS4/DX/10 satin stainless steel AISI 304 DIN 1.4301

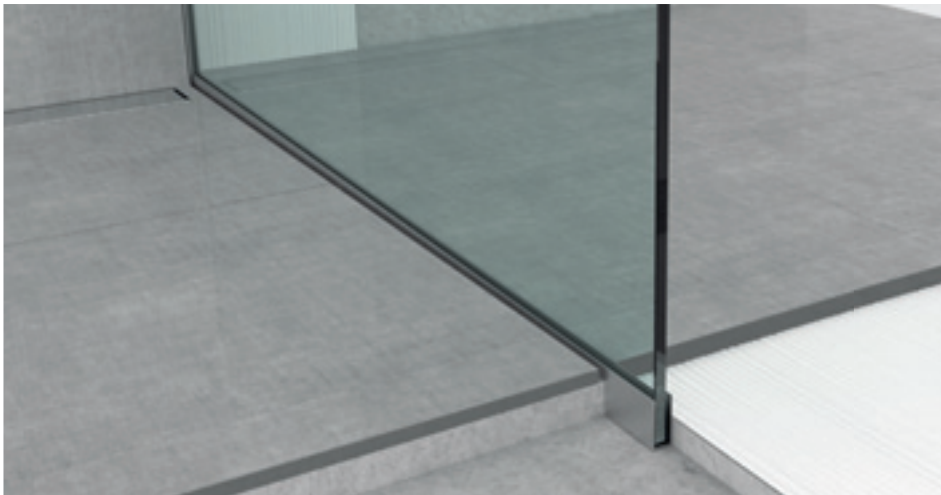

GU/ and TGU/ are anodised aluminium profiles suitable for the insertion of glass walls on the floor and on the wall of floor-level showers with Thin Drain, Slim Drain and Smart Drain.

GU/40/12 + TGU/12 silver anodised aluminium

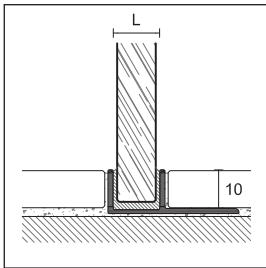

TGU/

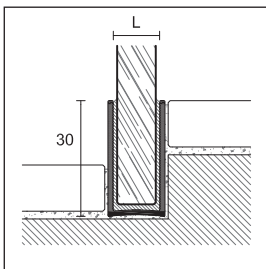

GU/30/

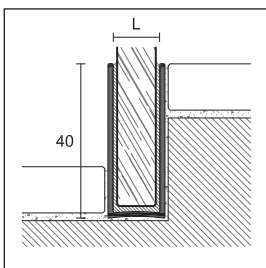

GU/40/

GLASS PROFILE

length = 270 cm - pack 10 pcs		L	
ART.	finishing	12	14
ALUMINIUM			
TGU/	silver anodised	67760	67762
<i>euro/m</i>			
individually packed			

GLASS PROFILE

length = 270 cm - pack 10 pcs		L	
ART.	finishing	12	14
ALUMINIUM			
GU/30/	silver anodised	67770	67772
<i>euro/m</i>			
GU/40/	silver anodised	67780	67782
<i>euro/m</i>			
individually packed			

Complete the article code with L measure
(for example GU/30/ for L=12 becomes GU/30/12)

For a single piece, see sales conditions on page 305

sanibord



BP/22 anti-mould white co-extruded PVC



BP/25 anti-mould white co-extruded PVC

Sanibord BP/22 and BP/25 are technical profiles in coextruded PVC to be installed between the covering and the bath tub or shower tray during the laying. These profiles allow to avoid the use of silicone and, besides the aesthetic advantages, guarantee a high hygienic level over time.

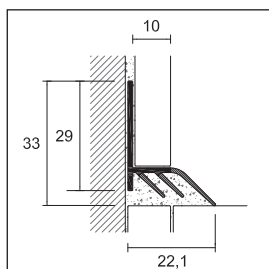

BP/22

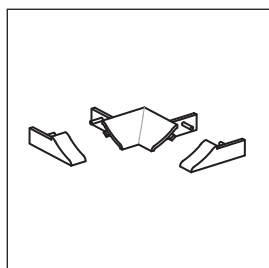

BPT/22

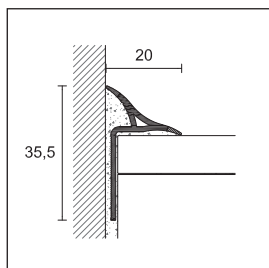

BP/25

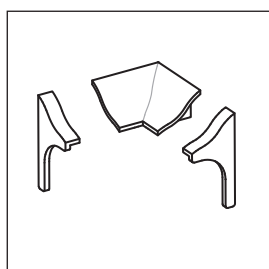

BPT/25

SANIBORD

length = 270 cm - pack 20 pcs

ART. finishing

CO-EXTRUDED PVC

BP/22 anti-mould white 95520

euro/m

no partial packaging

INSIDE CORNER AND RIGHT/LEFT END CAPS FOR BP/22

pack 6 blister

ART. finishing

POLYPROPYLENE

BPT/22 white 95530

euro/blister

no partial packaging

SANIBORD

length = 270 cm - pack 20 pcs

ART. finishing

CO-EXTRUDED PVC

BP/25 anti-mould white 95540

euro/m

no partial packaging

INSIDE CORNER AND RIGHT/LEFT END CAPS FOR BP/25

pack 6 blister

ART. finishing

POLYPROPYLENE

BPT/25 white 95545

euro/blister

no partial packaging

KIT: 1 PC OF 180 CM + 2 PCS OF 90 CM + 2 INSIDE CORNERS AND RIGHT/LEFT END CAPS

pack 10 pcs

ART. finishing

CO-EXTRUDED PVC

BPK/25 anti-mould white 95494

euro/kit

individually packed - no partial packaging



BP/20 anti-mould white co-extruded PVC

Sanibord BH/20 and BP/20 are technical profiles in colour-coated aluminium and coextruded PVC to be installed between the covering and the bath tub or the shower tray. These profiles allow to avoid the use of silicone and, besides the aesthetic advantages, guarantee a high hygienic level over time.

BH/20 in colour-coated aluminium is provided with the certified antibacterial technology (according to the internationally recognized laboratory test JIS Z 2801:2000) which allows to reduce the presence of the most dangerous bacteria up to 99%.

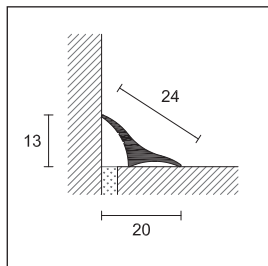

BH/20

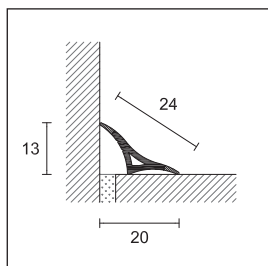

BP/20

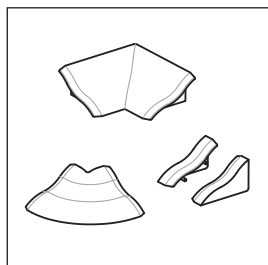

BPT/20

SANIBORD

length = 270 cm - pack 20 pcs

ART. finishing

ANTIBACTERIAL COLOUR-COATED ALUMINIUM

BH/20	colour-coated white antibacterial RAL 9003	<input type="checkbox"/>	95459
euro/m			
BH/20/A adhesive	colour-coated white antibacterial RAL 9003	<input type="checkbox"/>	95460
euro/m			

SANIBORD

length = 270 cm - pack 20 pcs

ART. finishing

CO-EXTRUDED PVC

BP/20	anti-mould white	<input type="checkbox"/>	95490
euro/m			
BP/20/A adhesive	anti-mould white	<input type="checkbox"/>	95470
euro/m			

no partial packaging

INSIDE CORNER, OUTSIDE CORNER, RIGHT/LEFT END CAPS FOR BH/20 AND BP/20

pack 6 blister

ART. finishing

POLYPROPYLENE

BPT/20	white	<input type="checkbox"/>	95480
euro/blister			

no partial packaging

KIT: 1 PC OF 180 CM + 2 PCS OF 90 CM + 2 INSIDE CORNERS AND RIGHT/LEFT END CAPS

pack 10 pcs

ART. finishing

CO-EXTRUDED PVC

BPK/20	anti-mould white	<input type="checkbox"/>	95544
euro/kit			

individually packed excepted BP20 - no partial packaging

MS POLYMER-BASED ADHESIVE FOR SKIRTING BOARDS

quantity 290 ml - pack 24 pcs

ART.

PP/96		<input type="checkbox"/>	78301
euro/pc			





profiles for floors of same height

The range of profiles is designed to combine different materials with elegance and simplicity. The coupling of different materials thus becomes interior style and not visual limit.





AI/10 stainless steel AISI 304 DIN 1.4301

Proangle is a line of profiles to smooth, seal, protect and decorate floors of same level in ceramic, marble, granite, wood or other material. It is also ideal as a separation joint between floors and decoration made of different materials (eg. between ceramic flooring and parquet or carpet). The stainless steel version is recommended as a finishing profile and protection for the edges of steps, platforms and plans of work and as perimeter profile for the shaping of doormats. Proangle B proposed in natural aluminium, is particularly suitable where it is necessary to proceed to polishing, even deep, of marble, resin and wood floor surfaces.

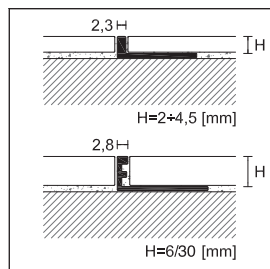

ZG/
ZA/
ZN/

PROANGLE

length = 270 cm - pack 20 pcs

		H					
ART.	finishing	2	2,5	3	4,5	6	
ALUMINIUM							
ZG/	natural aluminium		90207	90206	90208	90210	88159
	<i>euro/m</i>						
ZA/	silver anodised		90336	90337	90338	90340	88204
	<i>euro/m</i>						
BRASS							
ZN/	natural brass		-	-	90078	90080	88024
	<i>euro/m</i>						
ZK/	chromium plated		-	-	90079	90081	88114
	<i>euro/m</i>						

individually packed - ZA/ H 10 and ZG/ H 8-10-12 are available in length of 90 cm euro/m + art. ZN/22,5 pack 5 pcs - art. ZN/25 and ZN/30 pack 10 pcs

PROANGLE

length = 270 cm - pack 20 pcs

		H					
ART.	finishing	3	4,5	5	6	8	
STAINLESS STEEL							
AI/	stainless steel AISI 304 DIN 1.4301		91636	91638	91640	91642	91644
	<i>euro/m</i>						
AIX/	stainless steel AISI 316 DIN 1.4404		-	-	-	91684	91685
	<i>euro/m</i>						

individually packed - AI/ H 10 is available in length of 90 cm euro/m +

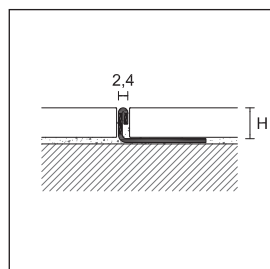

AI/
AIX/

Profiles PROANGLE sandblasted and satin stainless steel finish see page 75

Complete the article code with H measure (for example ZG/ for H=10 becomes ZG/10)

ZG/, ZN/, AI/ and ZBG/ Flex version see page 223

Items AIX/ in other heights, on demand for minimum 540 meters for each height

For a single piece, see sales conditions on page 305



ZG/10 natural aluminium

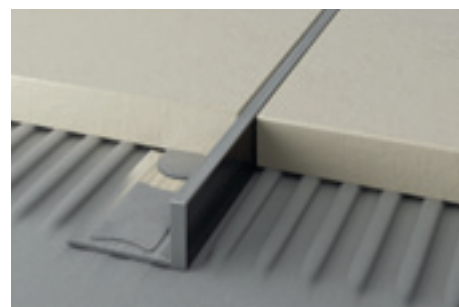

ZBG/10 natural aluminium



ZN/10 natural brass

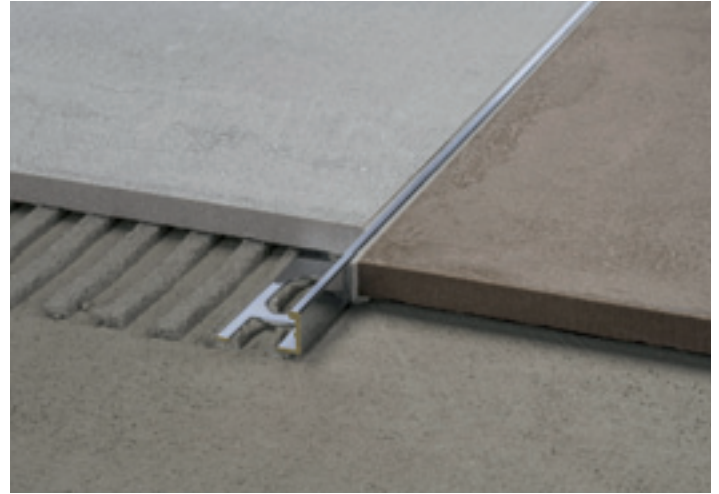

ZK/10 chromium-plated brass

H												
8	9	10	11	12,5	14	15	17,5	20	22,5	25	27,5	30
88160	88155	88161	88156	88162	88157	88163	88164	88165	88166	88167	88168 *	88169
88205	88217	88206	88218	88207	-	88208	88209	88210	88211	88212	-	88214
					-						-	
88025	88037	88026	88038	88027	-	88028	88029	88030	88031	88032 *	-	88034
					-						-	
88115	-	88116	88118	88117	-	-	-	-	-	-	-	-
	-				-	-	-	-	-	-	-	-

H											
9	10	11	12,5	14	15	17,5	20	22,5	25	27,5	30
91645	91646	91647	91648	91649	91650	91652	91654	91656	91658	91660	91662
-	91686	91688	91687	-	-	-	-	-	-	-	-
-				-	-	-	-	-	-	-	-

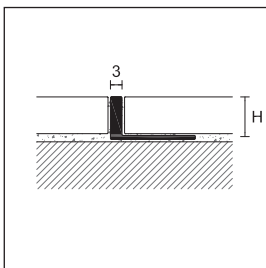

ZBG/

PROANGLE B

length = 270 cm - pack 20 pcs

		H					
ART.	finishing	8	10	12,5	15	20	22,5
ALUMINIUM							
ZBG/	natural aluminium	90010	90012	90014	90016	90018	90020
	euro/m						

individually packed

* Out of production items, available till end of stock

Complete the article code with H measure (for example ZBG/ with H=10 becomes ZBG /10)

For a single piece, see sales conditions on page 305



DJK/15 chromium-plated brass

Prodecor is a line of profiles made for finish, seal, protect and decorate floors of same level in ceramic, marble, granite, wood or other materials. It is also ideal as a separation joint between floors and decoration made of different materials (eg. between ceramic flooring and parquet or carpet). edge profile for the sharpening of doormats, protection for footboard and / or ceramic steps. The thickness in view of Prodecor makes the separation element of elegant visual impact, combining it with the floor.

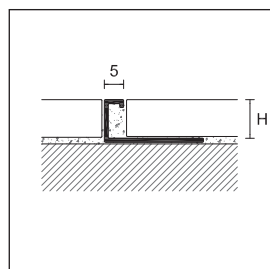

DA/10 silver anodised aluminium

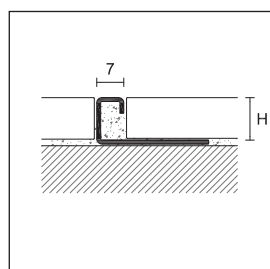

DI/

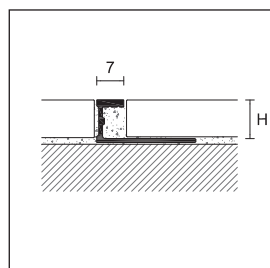

DG/
DA/
DN/
DK/

Complete the article code with H measure (for example DJG/ with H=8 becomes DJG/8)

For a single piece, see sales conditions on page 305

PRODECOR DJ

length = 270 cm - pack 20 pcs

ART.	finishing		8	10	12,5	15	20
ALUMINIUM							
DJG/	natural aluminium		95670	95672	95674	-	-
	<i>euro/m</i>					-	-
DJA/	silver anodised		95680	95682	95684	-	-
	<i>euro/m</i>					-	-
BRASS							
DJN/	natural brass		95690	95692	95694	95691	95693
	<i>euro/m</i>						
DJK/	chromium plated		95700	95702	95704	95703	95705
	<i>euro/m</i>						

individually packed - art. DJN/20 and DJK/20 pack 10 pcs

OUTSIDE AND INSIDE CORNERS

pack 5 pcs

ART.	finishing		8	10	12,5	15	20
ALUMINIUM							
DJG/ /EI	natural aluminium		95676	95677	95678	-	-
	<i>euro/pc</i>					-	-
ALUMINIUM							
DJA/ /EI	silver anodised		95686	95687	95688	-	-
	<i>euro/pc</i>					-	-
no partial packaging							
BRASS							
DJN/ /EI	natural brass		95696	95697	95698	95715	95716
	<i>euro/pc</i>						
DJK/ /EI	chromium plated		95706	95707	95708	95709	95710
	<i>euro/pc</i>						

no partial packaging

PRODECOR

length = 270 cm - pack 20 pcs

ART.	finishing		8	10	12,5	15	20
ALUMINIUM							
DG/	natural aluminium		95920	95922	95924	95926	-
	<i>euro/m</i>						-
DA/	silver anodised		95930	95932	95934	95936	-
	<i>euro/m</i>						-
STAINLESS STEEL							
DI/	polished stainless steel AISI 304 DIN 1.4301		95906	95908	95910	95911	95907
	<i>euro/m</i>						
art. DI/20 pack 10 pcs							
BRASS							
DN/	natural brass		95620	95622	95624	95626	-
	<i>euro/m</i>						-
DK/	chromium plated		95900	95902	95904	95905	-
	<i>euro/m</i>						-

individually packed - art. DK/12,5 and DK/15 pack 10 pcs

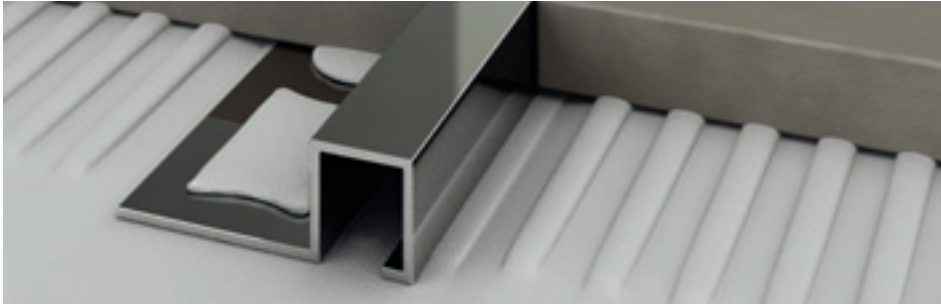

UG/12 chromium-plated brass

Prostyle is a line of multi-purpose profiles for finishing and decoration of floors of the same level in ceramic, marble, granite or other types of materials. It is also ideal as a separation joint and / or decoration between floors of different materials (eg, between ceramic flooring and parquet), and in the stainless steel version it solves problems related to the protection of ceramic steps or passage of heavy and frequent loads.

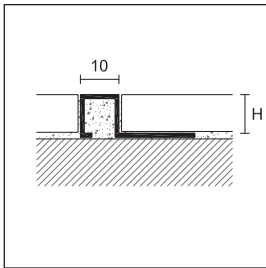

UG/
UA/
UN/
UK/

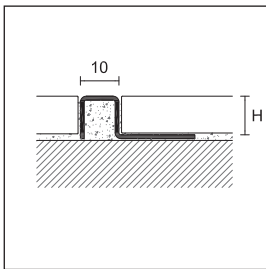

UI/
UIS/

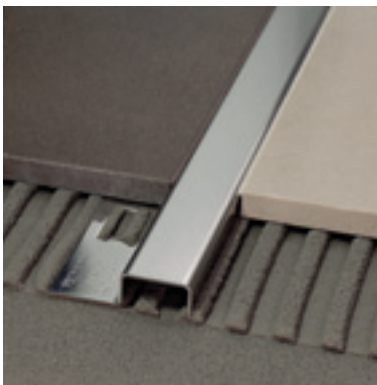

LUI/10 stainless steel AISI 304 DIN 1.4301

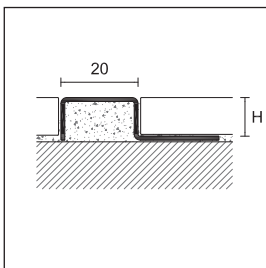

LUI/
LUIS/

Complete the article code with H measure (for example UG/ for H=8 becomes UG/8)

For a single piece, see sales conditions on page 305

PROSTYLE

length = 270 cm - pack 20 pcs		H						
ART.	finishing	8	10	11	12,5	15	20	
ALUMINIUM								
UG/	natural aluminium		93368	93370	-	93372	93377	-
	<i>euro/m</i>			-				-
UA/	silver anodised		93378	93380	-	93382	93387	-
	<i>euro/m</i>			-				-
length = 270 cm - pack 10 pcs								
STAINLESS STEEL								
UI/	polished stainless steel AISI 304 DIN 1.4301		93400	93401	-	93402	93403	93404
	<i>euro/m</i>			-				
UIS/	satin stainless steel AISI 304 DIN 1.4301		93348	93350	-	93352	93360	93361
	<i>euro/m</i>			-				
BRASS								
UN/	natural brass		93300	93302	93311	93304	93306	93308
	<i>euro/m</i>							
UK/	chromium plated		93325	93327	93312	93329	93338	93340
	<i>euro/m</i>							

individually packed

OUTSIDE AND INSIDE CORNERS

pack 10 pcs		H						
ART.	finishing	8	10	11	12,5	15	20	
ALUMINIUM								
UG/ /EI	natural aluminium		93373	93374	-	93375	93376	-
UA/ /EI	silver anodised		93383	93384	-	93385	93386	-
	<i>euro/pz</i>			-				-
no partial packaging								
STAINLESS STEEL								
UI/ /EI	polished stainless steel AISI 304 DIN 1.4301		93405	93406	-	93407	93408	93409
	<i>euro/pz</i>			-				
UIS/ /EI	satin stainless steel AISI 304 DIN 1.4301		93353	93354	-	93355	93356	93357
	<i>euro/pz</i>			-				
no partial packaging								
BRASS								
UN/ /EI	natural brass		93301	93303	93341	93305	93307	93309
	<i>euro/pz</i>							
UK/ /EI	chromium plated		93334	93335	93342	93336	93337	93339
	<i>euro/pz</i>							
no partial packaging								

PROSTYLE

length = 270 cm - pack 10 pcs		H			
ART.	finishing	8	10	12,5	
STAINLESS STEEL					
LUI/	polished stainless steel AISI 304 DIN 1.4301		93291	93292	93293
	<i>euro/m</i>				
LUIS/	satin stainless steel AISI 304 DIN 1.4301		93314	93315	93316
	<i>euro/m</i>				

individually packed



399/T/14 polished brass

Projoint T is a line of profiles for the separation, protection and decoration of floors at the same level in ceramic, marble, granite, wood or other materials. It is also ideal as covering of any imperfections due to the cutting or the laying of floors made of different materials (eg, between ceramic flooring and parquet). Its particular section permits to cover the gap between two different types of floor, where there is a slight difference in level (2 ÷ 3 mm). It is also easy to apply, thanks to the arrow-shaped profile which allows a perfect anchorage with sealants or adhesives.

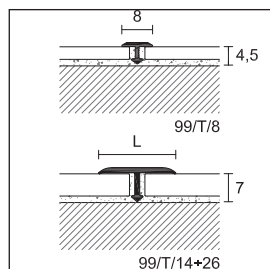

99/T/
399/T/
399/TC/



799/T/26 polished stainless steel AISI 304 DIN 1.4301

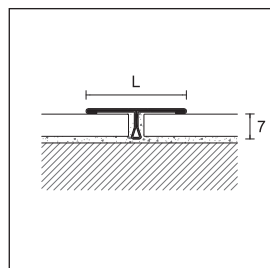







799/T/
799/TS/
799/TP/

Complete the article code with L measure (eg. 99/T with 99/T becomes 99/T/14)

 packaging in blister no partial packaging



For a single piece, see sales conditions on page 305

PROJOINT T - SEPARATION JOINTS





length = 270 cm - pack	50 pcs	50 pcs	30 pcs	20 pcs		
width	8	14	20	26		
ART.	finishing					
ALUMINIUM						
silver anodised		75075	75080	63600	75082	
gold anodised		-	75083	75084	75085	
<i>euro/m</i>						
99/T/	titanium anodised		-	75099	-	-
<i>euro/m</i>						
	colour-coated anthracite grey		-	75091	-	-
<i>euro/m</i>						
length = 270 cm - pack	50 pcs	20 pcs	20 pcs	20 pcs		
BRASS						
399/T/	polished		75070	75087	75090	75088
<i>euro/m</i>						
	pack		30 pcs	30 pcs	-	10 pcs
399/TC/	chromium plated		75071	75086	-	75089
<i>euro/m</i>						

individually packed

PROJOINT T - SEPARATION JOINTS

length = 90 cm - pack 10 pcs / blister		L	
ART.	finishing		
ALUMINIUM			
silver anodised		20008	
499/T	gold anodised		20010
<i>euro/pc</i>			
BRASS			
4399/T	polished		20016
<i>euro/pc</i>			

PROJOINT T - SEPARATION JOINTS

length = 270 cm - pack	30 pcs	20 pcs		
width	14	26		
ART.	finishing			
STAINLESS STEEL				
799/T/	polished stainless steel AISI 304 DIN 1.4301		75092	75096
<i>euro/m</i>				
799/TS/	satin stainless steel AISI 304 DIN 1.4301		75093	75097
<i>euro/m</i>				
799/TP/	sandblasted stainless steel AISI 304 DIN 1.4301		75094	-
<i>euro/m</i>				
individually packed				
length = 90 cm - pack 10 pcs / blister				
4799/T	polished stainless steel AISI 304 DIN 1.4301		20001	-
<i>euro/pc</i>				
4799/TS	satin stainless steel AISI 304 DIN 1.4301		20002	-
<i>euro/pc</i>				



399/R/10 natural brass

Projoint R is a line of profiles for subdivision and / or decoration of floors of the same level in ceramic, marble, granite, wood or other materials. The thickness of the upper part makes it particularly suitable for the polishing of wood, marble, etc...

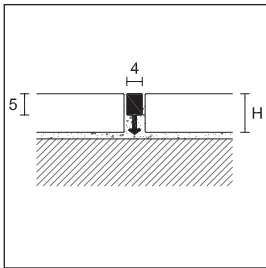

99/R/
399/R/

PROJOINT R - SEPARATION JOINTS

length = 270 cm - pack 50 pcs		H	
ART.	finishing	10	14
ALUMINIUM			
99/R/	natural aluminium		75006
	<i>euro/m</i>		75016
length = 270 cm - pack 20 pcs		H	
BRASS			
399/R/	natural brass		75007
	<i>euro/m</i>		75017
length = 90 cm - pack 10 pcs			
BRASS			
4399/R/10	natural brass		20006
	<i>euro/pc</i>		-



399/M natural brass

Projoint M is ideal as a separation joint and / or renovation and decoration between floors of the same level laid with glue or mortar. Used between materials of different thickness or type, it could also be polished both in the aluminium and brass version.

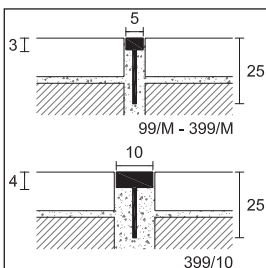

99/M
399/M
399/10

PROJOINT M - SEPARATION JOINTS

length = 270 cm - pack		50 pcs	
measures		5x3x25	10x4x25
ART.	finishing		
ALUMINIUM			
99/M	natural aluminium		75005
	<i>euro/m</i>		-
	pack		-
			20 pcs
			10 pcs
BRASS			
399/M	natural brass		74975
	<i>euro/m</i>		-
399/10	natural brass		-
	<i>euro/m</i>		74906

Complete the article code with H measure (eg. 99/R/ with H=10 becomes 99/R/10)

packaging in blister no partial packaging

For a single piece, see sales conditions on page 305

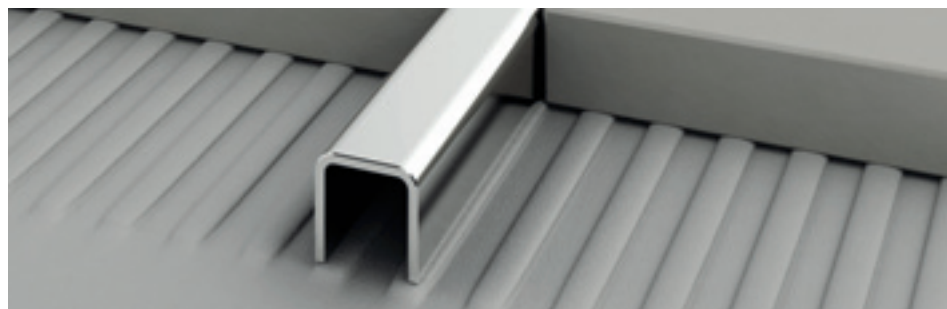

799/U/12 polished stainless steel AISI 304 DIN 1.4301

Projoint U and Projoint they are a range of separation joints in stainless steel and brass, especially suitable in case of transit of high and frequent loads. The version 799 / in case of need can be inserted and polished even after the installation after the cutting of the flooring.

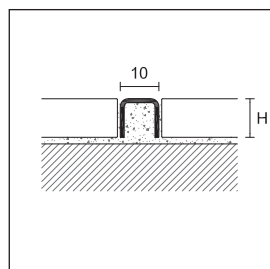

799/U/
399/U

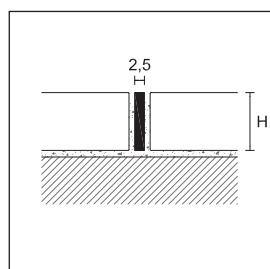

799/

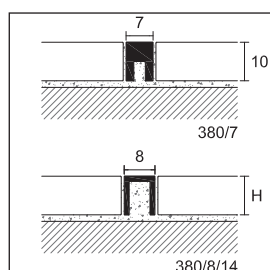
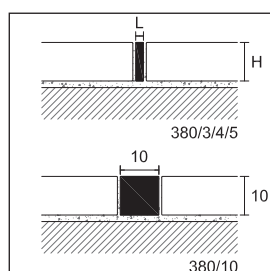

Complete the article code with H measure (eg. 799/U/ with H=10 becomes 799/U/10)

* Out of production items, available till end of stock

For a single piece, see sales conditions on page 305

PROJOINT U - SEPARATION JOINTS

length = 270 cm - pack		20 pcs	20 pcs	20 pcs	20 pcs	
H		10	12,5	15	20	
ART. finishing						
STAINLESS STEEL						
799/U/	polished stainless steel AISI 304 DIN 1.4301		75078	75072	75073	75074
<i>euro/m</i>						
BRASS						
399/U	brass polished		75077	-	-	-
<i>euro/m</i>						

individually packed

PROJOINT - SEPARATION JOINTS

length = 270 cm - pack		20 pcs	20 pcs	10 pcs	5 pcs	
H		10	15	20	40	
ART. finishing						
STAINLESS STEEL						
799/	stainless steel AISI 304 DIN 1.4301		74966	74968 *	74970 *	74972 *
<i>euro/m</i>						

PROJOINT - SEPARATION JOINTS

length = 200 cm - pack 10 pcs		measures LxH			
ART. finishing					
BRASS					
380/4	natural brass		2x15		12510 *
<i>euro/m</i>					
380/5	natural brass		2x20		12514 *
<i>euro/m</i>					
380/3	natural brass		3x10		75032
<i>euro/m</i>					
380/10	natural brass		10x10		12598 *
<i>euro/m</i>					

PROJOINT - SEPARATION JOINTS

length = 270 cm		measures LxH		pack	
ART. finishing					
BRASS					
380/7	natural brass		7x10	10	75037 *
<i>euro/m</i>					
380/8	natural brass		8x10	20	75047
<i>euro/m</i>					
380/14	natural brass		8x14	20	75067 *
<i>euro/m</i>					



30/A silver anodised aluminium

Proclassic R is a line of profiles specifically designed as a cover for entrance to hide the junctions and imperfections due to the cutting or laying between floors of different nature (eg between ceramic flooring and parquet or carpet). The rounded section, compared to the flat version, allows to compensate a slight difference in height (2 to 3 mm) between two different types of flooring. The fixing also appears to be particularly easy, thanks to the possibility of fixing with adhesive or screws.

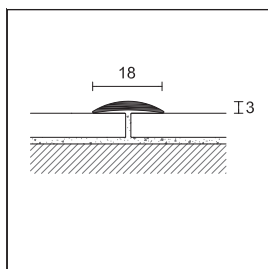

21/

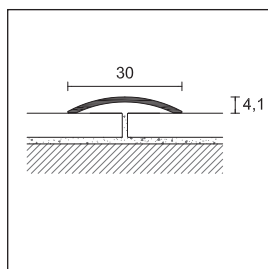

30/

PROCLASSIC R

length = 270 cm - pack 20 pcs

ART.	finishing		F	A
ALUMINIUM				
21/	silver anodised		71007 *	71037
	gold anodised		-	71047
<i>euro/m</i>				
individually packed				

PROCLASSIC R

pack	30 pcs		10 pcs / blister								
length cm	270		83		93		103		166		
ART.	30/		430/								
finishing	F	A	CV	AD	CV	AD	CV	AD	CV	AD	
ALUMINIUM											
silver anodised		71067	71097	20128	20148	20132	20152	-	20156	20140	20160
gold anodised		71077	71107	20129	20149	20133	20153	-	20157	20141 *	20161
bronze anodised		71087 *	71117	-	-	20134 *	20154	-	-	-	-
<i>euro/m</i>											
<i>euro/pc</i>											
titanium anodised		-	71098	-	-	-	-	-	-	-	-
<i>euro/m</i>											
colour-coated anthracite grey		-	71101	-	-	-	-	-	-	-	-
<i>euro/m</i>											

individually packed

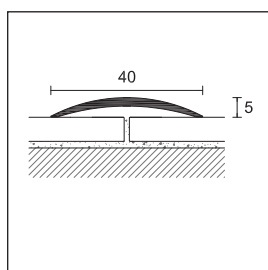
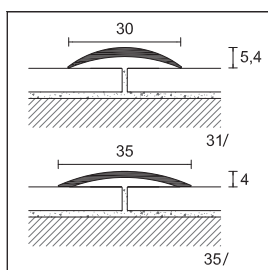

41/

PROCLASSIC R

length = 270 cm - pack 20 pcs

ART.	31/		35/		
finishing	F	A	F	A	
ALUMINIUM					
silver anodised		71127	71157	71387	71417
gold anodised		-	-	71397 *	71427 *
bronze anodised		-	-	71407 *	71437 *
<i>euro/m</i>					
individually packed					

PROCLASSIC R

pack	20 pcs		10 pcs / blister	
length cm	270		90	
ART.	41/		441/	
finishing	F	A	AD	
ALUMINIUM				
silver anodised		71587	71617	20552
gold anodised		71597	71627	20553
bronze anodised		-	71637	20554 *
<i>euro/m</i>				
<i>euro/pc</i>				
titanium anodised		71588 *	71618	20555
<i>euro/m</i>				
<i>euro/pc</i>				
individually packed				

Complete the article code with F= drilled, A-AD=adhesive, CV=with screws (for example 30/ becomes 30/F)

packaging in blister no partial packaging

* Out of production items, available till end of stock

For a single piece, see sales conditions on page 305



722/A satin stainless steel AISI 304 DIN 1.4301

Proclassic R in the stainless steel version is particularly suitable in public and private environments, and in the case of transit of high and frequent loads. The shine of the polished stainless steel also makes perfect the matching with the modern floorings and furnishings.

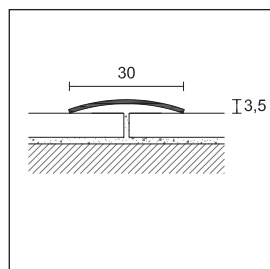

020/A polished brass

PROCLASSIC R

pack	20 pcs	PRO					
length cm	270	73	83	93	103	166	
ART.	720/	720/					
finishing	F A	F A	F A	F A	F A	F A	
STAINLESS STEEL							
polished stainless steel AISI 430 - DIN 1.4016	71287 71297	71280 71290	71281 71291	71282 71292	- -	71284* 71294	
euro/m	- -	- -	- -	- -	- -	- -	
euro/pc	- -	- -	- -	- -	- -	- -	

		10 pcs / blister					
ART.		4720/					
finishing		CV AD	CV AD	CV AD	CV AD	CV AD	
polished stainless steel AISI 430 - DIN 1.4016	- -	20287 20293	20288 20294	20289 20295	20290 20296	20291 20297	
euro/pc	- -	- -	- -	- -	- -	- -	
satin stainless steel AISI 430 - DIN 1.4016	- 71298	- -	- -	- -	- -	- -	
euro/m	- -	- -	- -	- -	- -	- -	

individually packed

PROCLASSIC R

pack	20 pcs	10 pcs / blister					
length cm	270	73	83	93	103	166	
ART.	722/	4722/					
finishing	F A	CV AD	CV AD	CV AD	CV AD	CV AD	
STAINLESS STEEL							
satin stainless steel AISI 304 - DIN 1.4301	71269 71268	- -	- -	20310* 20300	- -	- -	
euro/m	- -	- -	- -	- -	- -	- -	
euro/pc	- -	- -	- -	- -	- -	- -	

individually packed

PROCLASSIC R

pack	20 pcs	PRO					
length cm	270	73	83	93	103	166	
ART.	020/	020/					
finishing	F A	F A	F A	F A	F A	F A	
BRASS							
polished	71187 71207	- -	71181* 71201*	71182 71202	71183* 71203	71184* 71204*	
euro/m	- -	- -	- -	- -	- -	- -	
euro/pc	- -	- -	- -	- -	- -	- -	

		10 pcs / blister					
ART.		4020/					
finishing		CV AD	CV AD	CV AD	CV AD	CV AD	
polished	- -	20207 20213	20208 20214	20209 20215	20210 20216	20211 20217	
euro/pc	- -	- -	- -	- -	- -	- -	

individually packed

Complete the article code with F= drilled, A=adhesive, CV=with screws (for example 720/ drilled becomes 720/F)

packaging in blister no partial packaging

* Out of production items, available till end of stock

For a single piece, see sales conditions on page 305



726/A polished stainless steel AISI 430 DIN 1.4016

Proclassic are available in different widths and materials; the flat aluminium versions have a useful non - slip knurling and do not create thickness under the doors. Aso these versions can be fixed both with adhesive and screws.

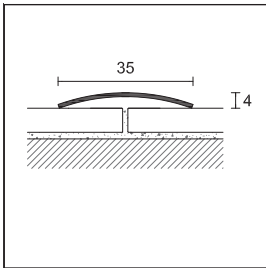

726/

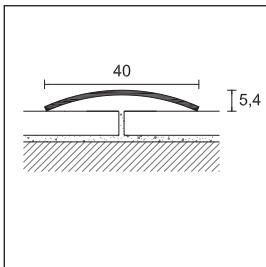

729/

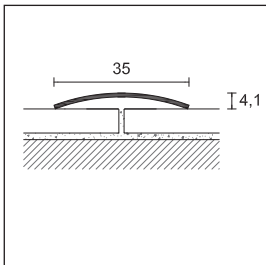

026/

PROCLASSIC R

pack	20 pcs		PRO			
length	270		83	93	166	
ART.	726/		726/			
finishing	F	A	F	A	F	A

STAINLESS STEEL

polished stainless steel AISI 430 - DIN 1.4016		71507	71517	-	-	71502	71512	-	-
euro/m		-	-	-	-	-	-	-	-
euro/pc		-	-	-	-	-	-	-	-

	10 pcs / blister					
ART.	4726/					
finishing			CV	AD	CV	AD
polished stainless steel AISI 430 - DIN 1.4016		-	-	26016	26010	26017
euro/pc		-	-	-	-	-

satin stainless steel AISI 430 - DIN 1.4016		-	71518	-	-	-	-
euro/m		-	-	-	-	-	

individually packed

PROCLASSIC R

pack	20 pcs		5 pcs / blister	
length	270		93	
ART.	729/		4729/	
finishing	F	A	CV	AD

STAINLESS STEEL

polished stainless steel AISI 430 - DIN 1.4016		71667	71677	40214	40220
euro/m		-	-	-	-
euro/pc		-	-	-	-
satin stainless steel AISI 430 - DIN 1.4016		-	71678	-	-
euro/m		-	-	-	-

individually packed

PROCLASSIC R

pack	20 pcs		PRO	
thickness =10/10 - length cm	270		93	
ART.	026/		026/	
finishing	F	A	F	A

BRASS

polished		71447	71457	71442 *	71452 *
euro/m		-	-	-	-
euro/pc		-	-	-	-

	10 pcs / blister	
ART.	4026/	
finishing	CV	AD
polished		20409
euro/pc		20415

individually packed

Complete the article code with F= drilled, A-AD=adhesive, CV=with screws (for example 726/ drilled becomes 726/F)

packaging in blister no partial packaging

* Out of production items, available till end of stock

For a single piece, see sales conditions on page 305

proclassic



25/A silver anodised aluminium



525/A polished brass

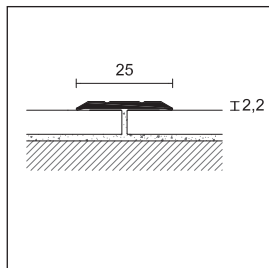

19/

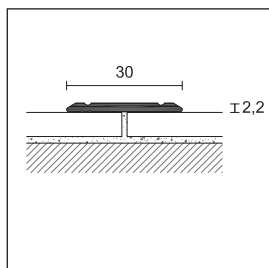

24/

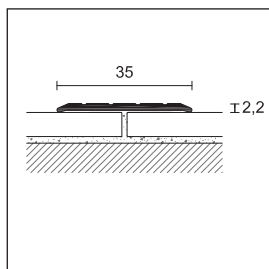

25/

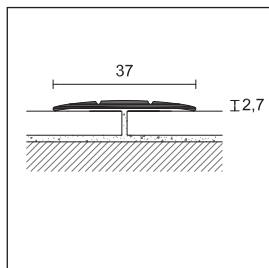

23/





Complete the article code with F= drilled, A/AD=adhesive, CV=with screws (for example 19/ drilled becomes 19/F)

 packaging in blister no partial packaging

• Out of production items, available till end of stock



For a single piece, see sales conditions on page 305
129

PROCLASSIC F

pack	30 pcs		10 pcs / blister 		
length cm	270		93		
ART.	19/		419/		
finishing	F	A	CV	AD	
ALUMINIUM					
silver anodised		71867	71897	27074	27092
gold anodised		71877	71907	27080	27099
bronze anodised		71887 *	71917	27086 *	27106 *
euro/m			-	-	
euro/pc			-	-	





individually packed

PROCLASSIC F

pack	20 pcs		10 pcs / blister 		
length cm	270		90		100
ART.	24/		424/		
finishing	F	A	CV	CV	
ALUMINIUM					
silver anodised		79067	79097	00230	00231
gold anodised		79077	79107	00234	00235
euro/m			-	-	
euro/pc			-	-	



individually packed

PROCLASSIC F

pack	20 pcs		10 pcs / blister 			
length cm	270		93			
ART.	25/		425/			
finishing	F	D	A	CV	AD	
ALUMINIUM						
silver anodised		71947	71948	71977	22533	22553
gold anodised		71957	-	71987	22534	22554
bronze anodised		71967 *	71968 *	71997	22535 *	22555
euro/m			-	-		
euro/pc			-	-		

individually packed

PROCLASSIC F

length = 270 cm - pack 20 pcs				
ART.	finishing	F	A	
ALUMINIUM				
23/	silver anodised		64007	64037
	gold anodised		64017	64047
	bronze anodised		64027 *	64057 *
euro/m				

individually packed

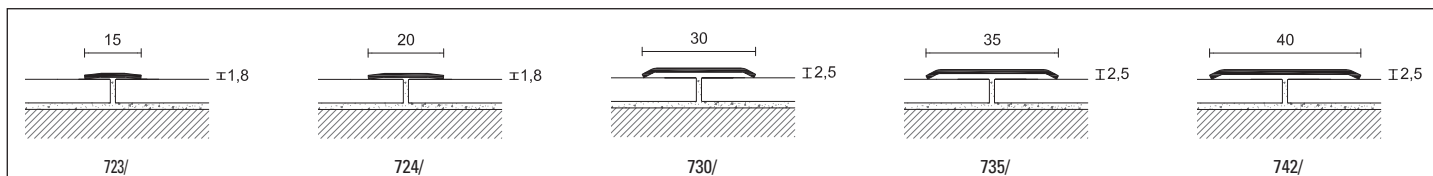

PROCLASSIC F

pack	20 pcs				10 pcs / blister		20 pcs		10 pcs				
length cm	270				93		270						
measures LxH	15x1,8		20x1,8		30x2,5		30x2,5		35x2,5 40x2,5 thickness 12/10				
ART.	723/		724/		730/		4730/		735/ 742/				
finishing	F	A	F	A	F	A	CV	AD	F	A			
STAINLESS STEEL													
polished stainless steel AISI 430 - DIN 1.4016		-	71717	-	71777	72107	72117	20689	20695	-	72237	72387	72397
euro/m	-	-	-	-	-	-	-	-	-	-	-	-	-
euro/pc	-	-	-	-	-	-	-	-	-	-	-	-	-

art. 723/ no individually packed - art. 730/, 735/ and 742/ individually packed

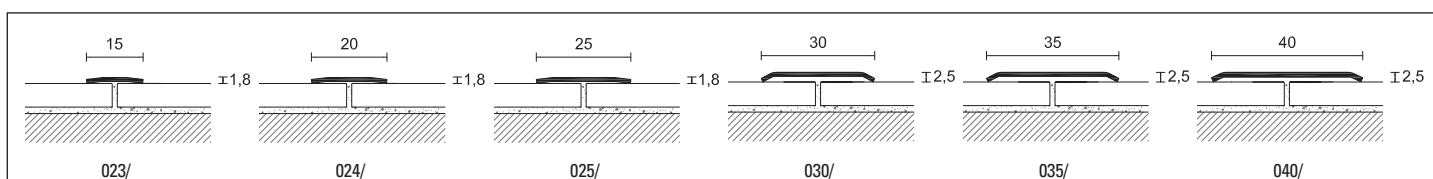

PROCLASSIC F

thickness 10/10 - length = 270 cm - pack 20 pcs													
measures LxH	15x1,8		20x1,8		25x1,8		30x2,5		35x2,5		40x2,5		
ART.	023/		024/		025/		030/		035/		040/		
finishing	SF	A	SF	A	F	A	F	A	F	A	F	A	
BRASS													
polished		71687 *	71697	-	71757	-	71817	72047 *	72057	-	72197	72307	72317
euro/m	-	-	-	-	-	-	-	-	-	-	-	-	-

art. 025/, 030/, 035/ and 040/ individually packed - art. 023/, 024/ and 025/ not individually packed - art. 040/F and 040/A pack 10 pcs

PROCLASSIC F

thickness = 10/10													
pack 10 pcs / blister				pack 5 pcs / blister									
length cm	93		103		166		93		93		103		
measures LxH	30x2,5		30x2,5		35x2,5		35x2,5		40x2,5				
ART.	4030/		4030/		4035/		4035/		4040/				
finishing	CV	AD	CV	AD	CV	AD	CV	AD	CV	AD	CV	AD	
BRASS													
polished		-	20615	-	20616	-	20617	20709 *	20715	20769 *	20775	-	20776
euro/pc	-	-	-	-	-	-	-	-	-	-	-	-	-

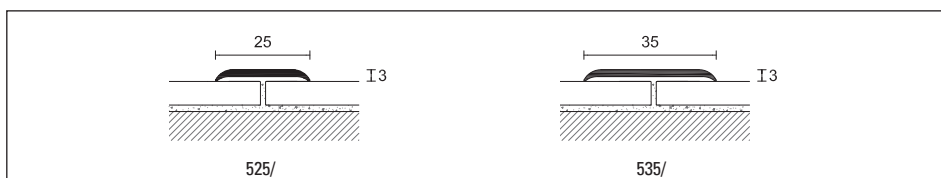

PROCLASSIC F

thickness = 18/10 - length 270 cm - pack 20 pcs					
measures LxH	25x3		35x3		
ART.	525/		535/		
finishing	F	A	F	A	
BRASS					
polished		-	72477 *	72487 *	72497 *
euro/m	-	-	-	-	-

individually packed

Complete the article code with F=drilled, A-AD=adhesive, CV=with screws (for example 723/ with adhesive becomes 723/A)

packaging in blister no partial packaging - * Out of production items, available till end of stock - For a single piece, see sales conditions on page 305





profiles for floors of different height

The range of profiles for floors of different height is made with a sloping section and allows to connect floors with different thicknesses. Products made of stainless steel, brass or aluminium, are chosen according to the target environment.



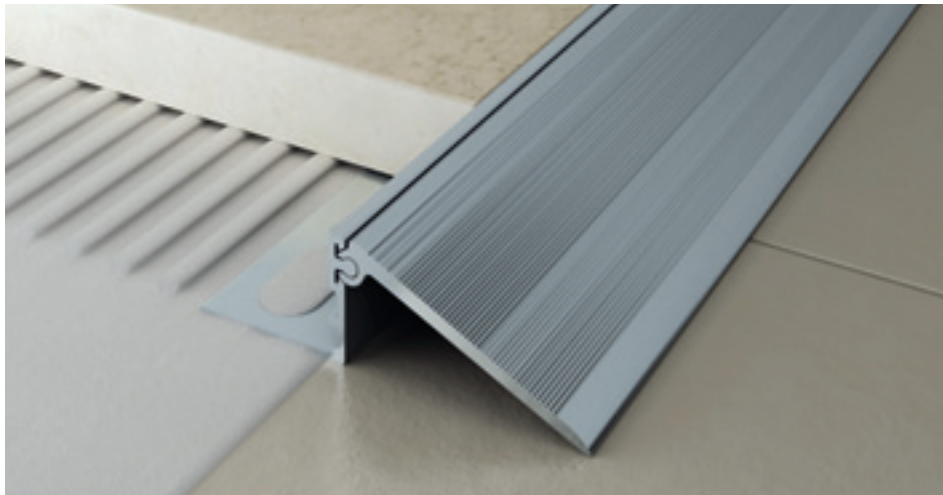

Pronivel NZS / is a line of connection between floors of different level composed by a bearing profile and two connection wings of different size. Together the two pieces allow the elimination of the step between floors of different thickness. The articulated connector permits many combinations and the laying of a new flooring on the side of the connector, even after the application of NZS /.

NZS/B/12 + NZS/S2 silver anodised aluminium

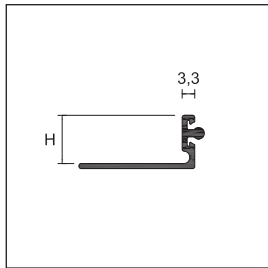

NZS/B/

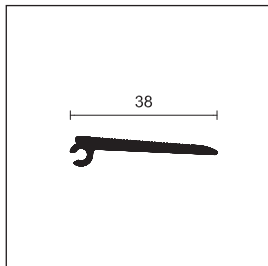

NZS/S1

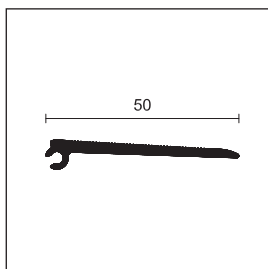

NZS/S2

PRONIVEL N

length = 270 cm - pack 10 pcs

		H			
ART.	finishing	10	12,5	15	20
ALUMINIUM					
NZS/B/	silver anodised	99905	99906	99907	99908
		L			
		38		50	
NZS/S1	connection silver anodised	99900			
NZS/S2	connection silver anodised			99901	

euro/m

individually packed

10 art. NZS/B/10	38,5 → +7 0 → -15	51 → +5 0 → -25
12,5 art. NZS/B/12,5	38 → +10 0 → -12	50,5 → +5 0 → -23
15 art. NZS/B/15	37 → +10 0 → -10	50 → +6 0 → -21
20 art. NZS/B/20	35 → +18 0 → -5	48 → +15 0 → -15

Complete the article code with H measure (eg. NZS/B/ with H=10 becomes NZS/B/10)

For a single piece, see sales conditions on page 305

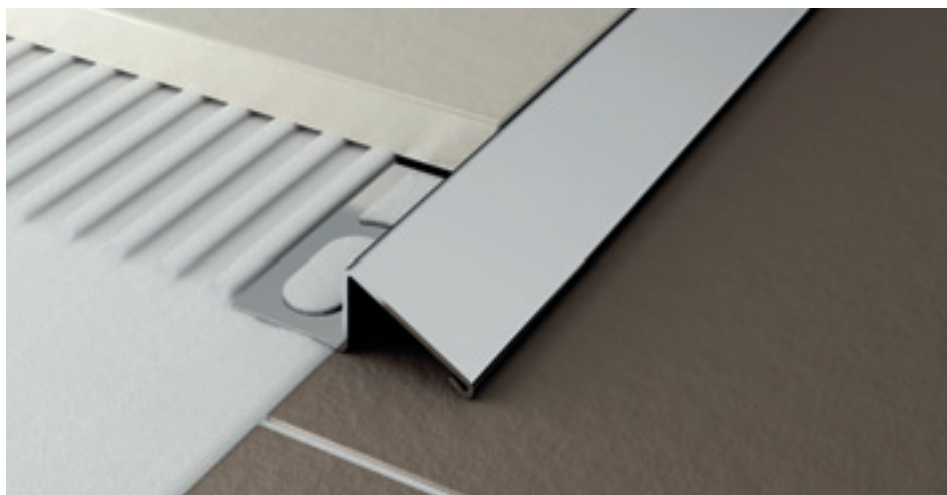

Pronivel P is a line of profiles to be applied during the laying of ceramic or marble flooring and suitable for connect different thicknesses. The versions in stainless steel and brass are suitable to withstand heavy stress

PN1/10 polished stainless steel AISI 304 DIN 1.4301

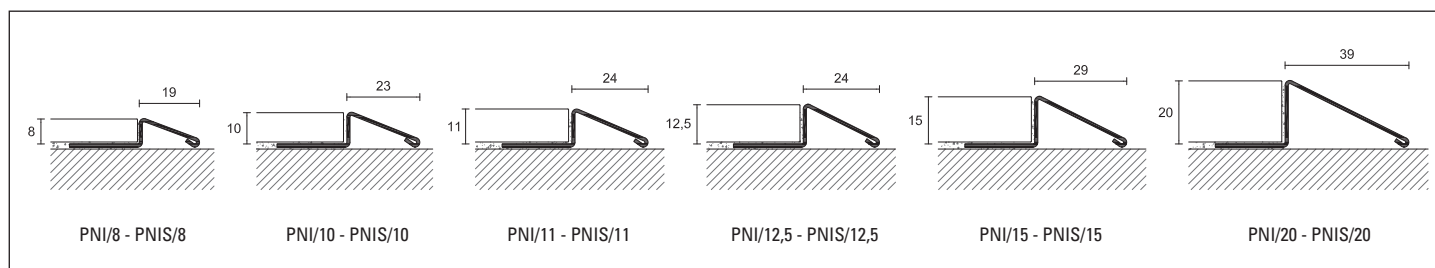
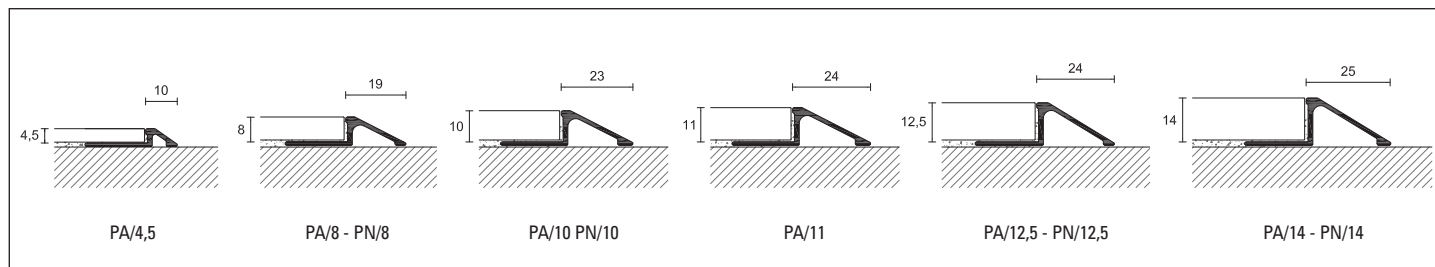

PRONIVEL P

length = 270 cm - pack 10 pcs		H							
ART.	finishing	4,5	8	10	11	12,5	14	15	20
ALUMINIUM									
PA/	silver anodised		93175	93181	93182	93185	93183	93184	-
	<i>euro/m</i>								-
STAINLESS STEEL									
PN1/	polished stainless steel AISI 304 DIN 1.4301		-	93092	93094	93090	93096	-	93098
	<i>euro/m</i>		-					-	
PNIS/	satin stainless steel AISI 304 DIN 1.4301		-	93093	93095	93091	93097	-	93099
	<i>euro/m</i>		-					-	
BRASS									
PN/	natural brass		-	93121	93122	-	93123	93124	-
	<i>euro/m</i>		-			-			-
PR/	polished		-	93151 *	93152 *	-	93153 *	93154 *	-
	<i>euro/m</i>		-			-			-

Complete the article code with H measure (eg. PA/ with H=8 becomes PA/8)

* Out of production items, available till end of stock

For a single piece, see sales conditions on page 305

individually packed - item PR/ available in length 90 cm - surcharge for cut euro



45/SF silver anodised aluminium

Pronivel L is a profile suitable to connect floors of different heights. Applicable on flooring already laid, it is fixed to the floor with adhesive.

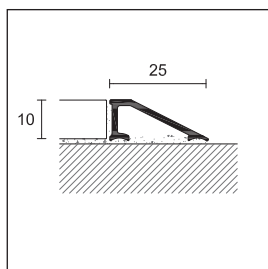

45/
345/

PRONIVEL L

length = 270 cm - pack 20 pcs H

ART. finishing 10

SF **A**

ALUMINIUM

45/	silver anodised		73550		73552
	<i>euro/m</i>				

length = 270 cm - pack 10 pcs H

BRASS 10

345/	polished		73553		73554 *
	<i>euro/m</i>				

individually packed



PBA/10 silver anodised aluminium

Pronivel PB is a transition profile between two floors subject to stress. The slight slope makes easier the passing of trolleys or wheelchairs.

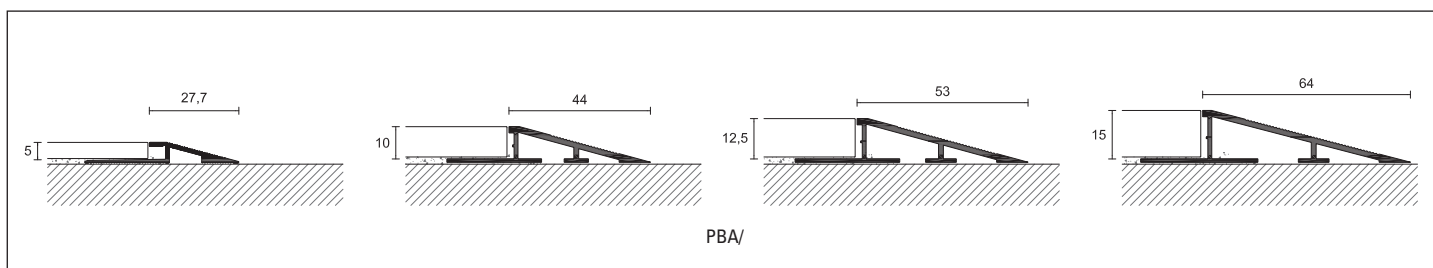

PRONIVEL PB

length = 270 cm - pack 10 pcs H

ART. finishing 5 10 12,5 15

ALUMINIUM

PBA/	silver anodised		93204	93206	93208	93210
	<i>euro/m</i>					

individually packed

Complete the article code with SF=undrilled, A=adhesive, (eg. 45/ adhesive becomes 45/A)

Complete the article code with the height (eg. PBA/ with H=10 becomes PBA/10)

* Out of production items, available till end of stock

For a single piece, see sales conditions on page 305



SWP/15 oak + aluminium

Pronivel Wood is a line of edge profiles in natural oak, which allows the elimination of the step between floors of different levels. Also suitable for laying a parquet over an existing floor allows the painting of the wooden part in the favourite shade.

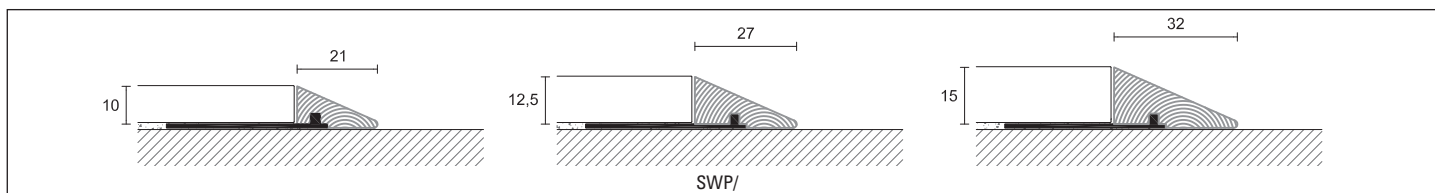

PRONIVEL WOOD

length = 270 cm - pack 10 pcs

		H		
ART.	finishing	10	12,5	15
OAK + ALUMINIUM				
SWP/	oak + aluminium	90550	90554	90558

euro/m

individually packed

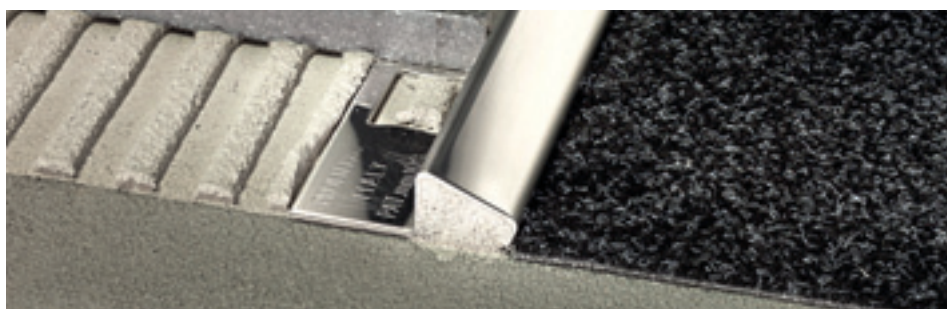

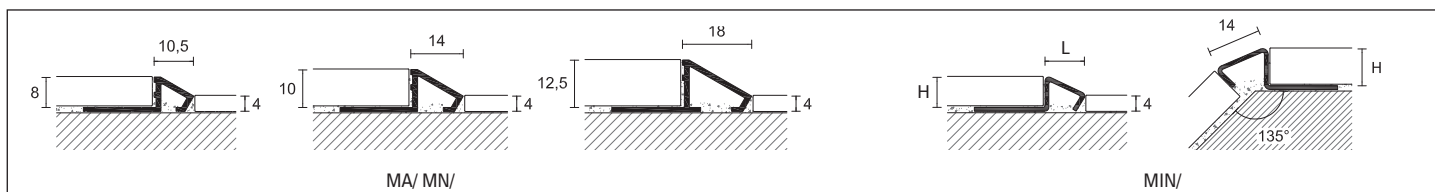

MIN/10 polished stainless steel AISI 304 DIN 1.4301

Pronivel M is a line of profiles designed to connect during installation floors of different heights. The special section is effective in case of connection with carpet or LVT.



PRONIVEL M

length = 270 cm - pack 10 pcs

		H			
ART.	finishing	8	10	12,5	
ALUMINIUM					
MA/	silver anodised		93010	93012	93014
STAINLESS STEEL					
MIN/	polished stainless steel AISI 304 DIN 1.4301		93023	93024	-

euro/m

BRASS

MN/	natural brass		92890 *	92892 *	92894 *
-----	---------------	---	---------	---------	---------

euro/m

individually packed

Complete the article code with the height (eg. SWP/ with H=10 becomes SWP/10)

* Out of production items, available till end of stock

For a single piece, see sales conditions on page 305





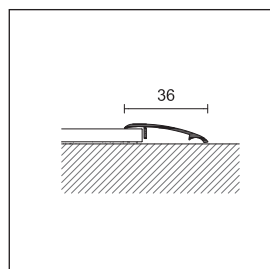

61/A silver anodised aluminium

Prolevel 61 / and 358 / are a line of profiles to be applied after the installation, and can compensate for differences in height between 6.5 and 13 mm.



61/
358/

PROLEVEL HIGH

pack	20 pcs	10 pcs / blister	
length cm	270	90	
ART.	61/	461/	
finishing	A	AD	
ALUMINIUM			
silver anodised	 73437	21200	
gold anodised	 73447 *	21201 *	
euro/m		-	
euro/pc	-		
pack	10 pcs	5 pcs / blister	
ART.	358/	4358/	
finishing	A	AD	
BRASS			
polished	 73467 *	22470 *	
euro/m		-	
euro/pc	-		

art. 61/ and 358/ individually packed

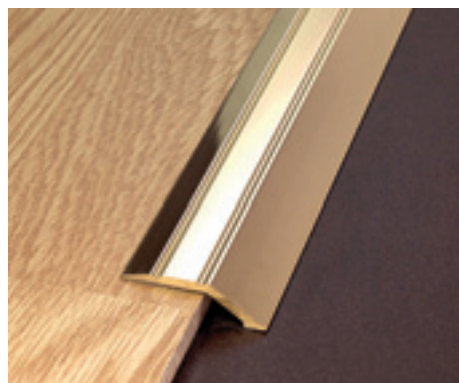



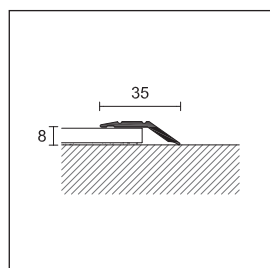

355/A polished brass

Prolevel 55/ and 355 / are a line of aluminium and brass profiles which allows the elimination of the step between floors with 8 mm slope. Available also in blister pack and self-adhesive, they are easily applicable in DIY field.



55/
355/

PROLEVEL HIGH

pack	20 pcs	10 pcs / blister	
length cm	270	90	
ART.	55/	455/	
finishing	F	A	CV AD
ALUMINIUM			
silver anodised	 73907	73937	42312 42330
gold anodised	 73917 *	73947	42318 42336
euro/m			- -
euro/pc	-	-	
pack	20 pcs	5 pcs / blister	
ART.	355/	4355/	
finishing	F	A	CV AD
BRASS			
polished	 73507 *	73517 *	- 22464 *
euro/m			- -
euro/pc	-	-	

art. 55/ and 355/ individually packed

Complete the item code with F=drilled, A-AD=adhesive, CV=screws (eg. 61/ adhesive becomes 61/A)

 packaging in blister no partial packaging - * Out of production items, available till end of stock - For a single piece, see sales conditions on page 305

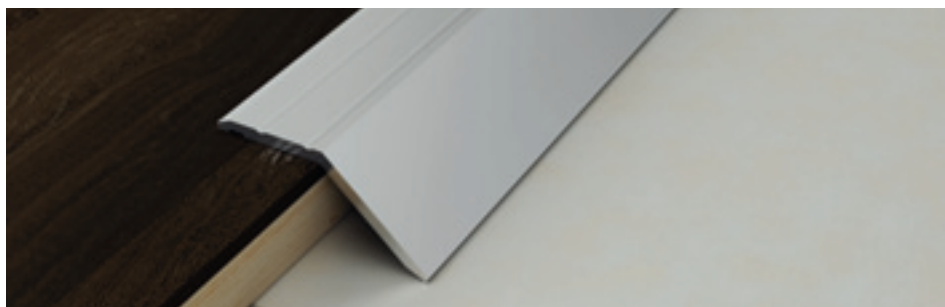

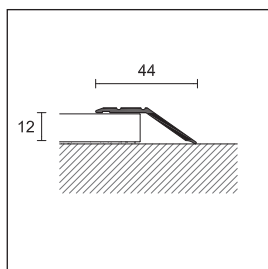

57/A silver anodised aluminium

Prolevel 57/ and 357 / are a line of aluminium and brass profiles which allows the elimination of the step between floors with 12 mm slope. Available also in blister pack and self-adhesive, they are easily applicable in DIY field.



57/

PROLEVEL HIGH

pack	20 pcs	10 pcs / blister 		
length cm	270	90		
ART.	57/	457/		
finishing	F	A	CV	AD
ALUMINIUM				
silver anodised	 73967	73997	42352	42370
gold anodised	 -	74007	42358	42376
euro/m			-	-
euro/pc	-	-		

art. 57/ individually packed

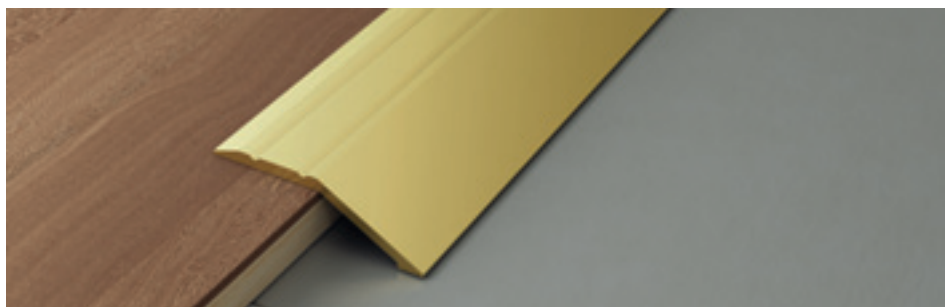

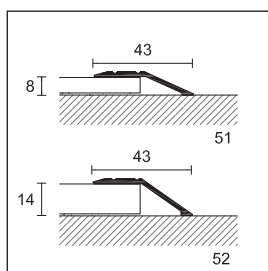

51/A gold anodised aluminium

Prolevel 51/ and 52/ are a line of aluminium profiles which allows the elimination of the step between floors with 8 or 14 mm slope. It could be used after the laying, using screws or adhesive.



PROLEVEL HIGH

length = 270 cm - pack 20 pcs				
ART.	51/		52/	
finishing	F	A	F	A
ALUMINIUM				
silver anodised	 74022	74026	74050	74056
gold anodised	 74023 *	74027	74051 *	74057
euro/m				

individually packed

Complete the article code with F=drilled, A=adhesive, CV=screws (eg. 57/ drilled becomes 57/F)

 packaging in blister no partial packaging - * Out of production items, available till end of stock - For a single piece, see sales conditions on page 305



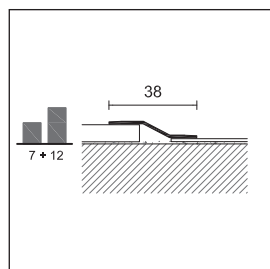

711/A polished stainless steel AISI 430 - DIN 1.4016

Prolevel 711/ and 311/ are a line of self-adhesive stainless steel and polished brass profiles which allows the elimination of the step between floors with 7 or 12 mm slope. Available also in blister pack and self-adhesive, they are easily applicable in DIY field.



711/
311/

PROLEVEL HIGH

pack	20 pcs	10 pcs / blister 			
length cm	270	83	93	103	166
ART.	711/	4711/			
finishing	A	AD	AD	AD	AD
STAINLESS STEEL					
polished stainless steel AISI 430 - DIN 1.4016	 73627	40431	40432	-	40434
euro/m	-	-	-	-	-
euro/pc	-	-	-	-	-
satin stainless steel AISI 430 - DIN 1.4016	 73628	-	-	-	-
euro/m	-	-	-	-	-

ART.	311/	4311/			
finishing	A	AD	AD	AD	AD
BRASS					
polished	 73607	22655	22656	22657	22658
euro/m	-	-	-	-	-
euro/pc	-	-	-	-	-

art. 711/ and 311/ individually packed



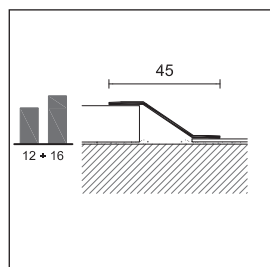

312/A polished brass

Prolevel 712/ and 312/ are a line of self-adhesive stainless steel and polished brass profiles which allows the elimination of the step between floors with 12 or 16 mm slope. Available also in blister pack and self-adhesive, they are easily applicable in DIY field.



712/
312/

PROLEVEL HIGH

pack	10 pcs	5 pcs / blister 	
length cm	270	90	
ART.	712/	4712/	
finishing	A	AD	
STAINLESS STEEL			
polished stainless steel AISI 430 - DIN 1.4016	 73637	40898	
euro/m	-	-	
euro/pc	-	-	
ART.	312/	4312/	
finishing	A	AD	
BRASS			
polished	 73617	40868	
euro/m	-	-	
euro/pc	-	-	

art. 712/ and 312/ individually packed



734/A polished stainless steel AISI 430 DIN 1.4016

Prolevel 034/ and 734/ are a line of stainless steel and brass profiles of small dimensions to apply after the laying to connect floors with a difference level of 10 mm.

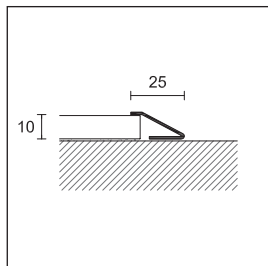

734/A
034/A

PROLEVEL HIGH

length = 270 cm - pack 15 pcs		H
ART.	finishing	10
STAINLESS STEEL		
734/A	polished stainless steel AISI 430 DIN 1.4016 <i>euro/m</i>	73737
BRASS		
034/A	polished <i>euro/m</i>	73667
individually packed		



032/SF/10 polished brass

Prolevel 732/ and 032/ are a line of border profiles to be used to protect border floor. Available in stainless steel and brass, it could be used also as stair nosing.

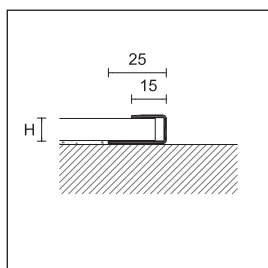

732/SF/
032/SF/

PROLEVEL HIGH

length = 270 cm - pack 15 pcs		H		
ART.	finishing	10	12,5	15
STAINLESS STEEL				
732/SF/	polished stainless steel AISI 430 DIN 1.4016 <i>euro/m</i>	74217	74227	74237
BRASS				
032/SF/	polished <i>euro/m</i>	74147 *	-	-
individually packed				

Complete the article code with H measure (eg. 732/SF/ with H=10 becomes 732/SF/10)

* Out of production items, available till end of stock

For a single piece, see sales conditions on page 305

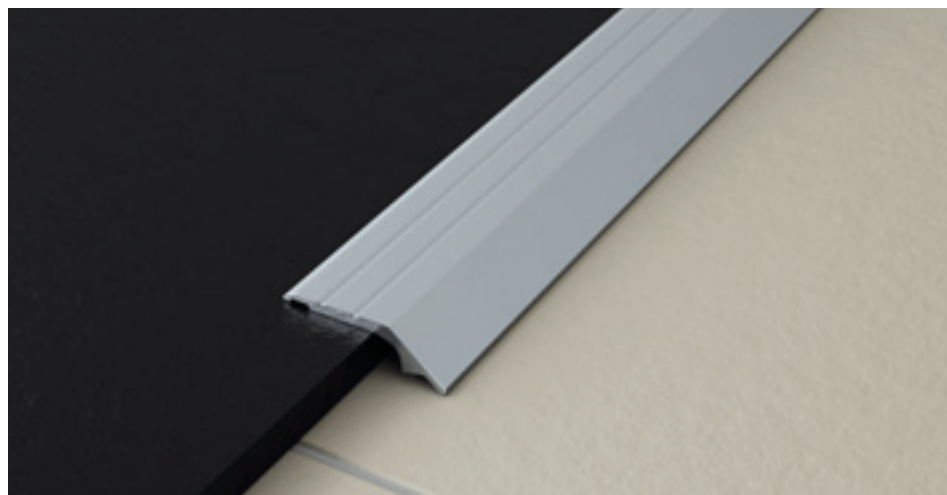



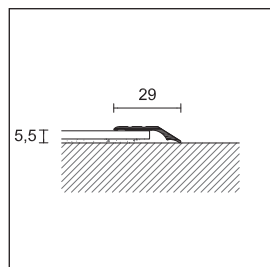

6/A silver anodised aluminium

Prolevel 6/ 7/ and 305/ are a line of transition profiles in aluminium and brass, for floors of small thickness already laid. Available also in blister pack, self-adhesive and with screws, they are easily applicable in DIY field.



6/

PROLEVEL MEDIUM

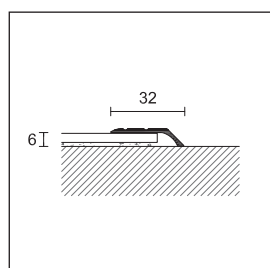

pack	30 pcs		10 pcs / blister 			
length cm	270		93		166	
ART.	6/		46/			
finishing	F	A	CV	AD	CV	AD
ALUMINIUM						
silver anodised		72727 72757	20932	20952	20940	20960
gold anodised		72737 72767	20933	20953	-	-
bronze anodised		72747* 72777	-	-	-	-
euro/m			-	-	-	-
euro/pc			-	-	-	-

art. 6/ individually packed



7/

PROLEVEL MEDIUM

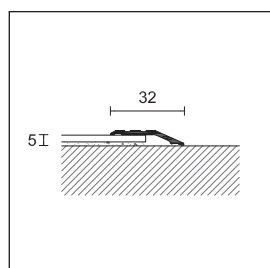

pack	30 pcs	
length cm	270	
ART.	7/	
finishing	F	
ALUMINIUM		
silver anodised		79007
gold anodised		79017*
euro/m		
euro/pc		

art. 7/ individually packed



305/

PROLEVEL MEDIUM

pack	10 pcs		10 pcs / blister 					
length cm	270		93		103		166	
ART.	305/		4305/					
finishing	F	A	CV	AD	CV	AD	CV	AD
BRASS								
polished		72787 72797	21009	21015	21010	21016	21011*	21017*
euro/m			-	-	-	-	-	-
euro/pc			-	-	-	-	-	-

art. 305/ individually packed

Complete the article code with F=drilled, A=adhesive, CV=screws (eg. 6/ drilled becomes 6/F)

 packaging in blister no partial packaging

* Out of production items, available till end of stock

For a single piece, see sales conditions on page 305

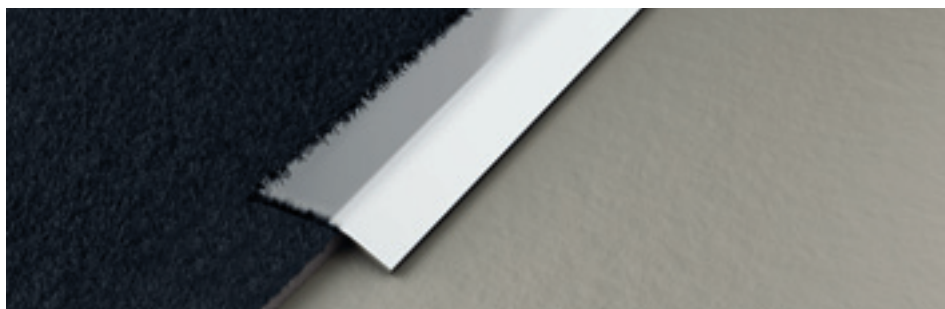

700/A polished stainless steel AISI 430 DIN 1.4016

Prolevel 700/, 300/ and 10/ are a line of transition profiles for floors of small thickness already laid. Available in different widths and also in blister pack, self-adhesive and with screws, they are easily applicable in DIY field.

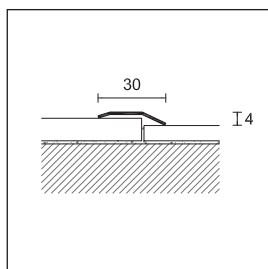

700/
300/

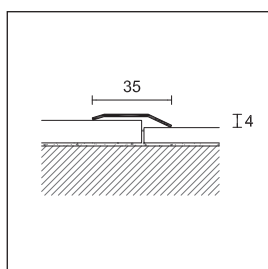

701/

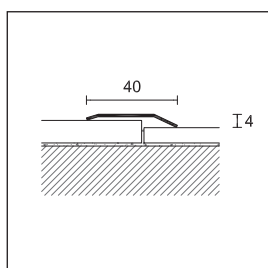

702/

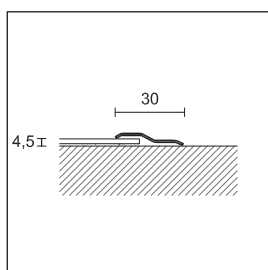



10/
710/
310/

Complete the article code with F=drilled, A-AD=adhesive, CV=screws (eg. 700/ drilled becomes 700/F)

 packaging in blister no partial packaging



For a single piece, see sales conditions on page 305

PROLEVEL MEDIUM

pack	20 pcs		10 pcs / blister 	20 pcs
length cm	270	270	93	270
ART.	700/	701/	4701/	702/
finishing	A	F A	AD	A
STAINLESS STEEL				
polished stainless steel AISI 430 DIN 1.4016 	72877	- 72957	21135	73057
euro/m	-	-	-	-
euro/pc	-	- -	-	-



art. 700/ 701/ 702/ individually packed

PROLEVEL MEDIUM

pack	20 pcs	10 pcs / blister 
length cm	270	93
ART.	300/	4300/
finishing	A	AD
BRASS		
polished 	72857	21035
euro/m	-	-
euro/pc	-	-

art. 300/ individually packed

PROLEVEL MEDIUM

pack	20 pcs		10 pcs / blister	20 pcs	10 pcs / blister
length cm	270		93	270	93
ART.	10/	710/	4710/	310/	4310/
finishing	A	A	AD	A	AD
ALUMINIUM					
silver anodised 	72527	-	-	-	-
STAINLESS STEEL					
polished stainless steel AISI 430 DIN 1.4016 	-	72567	20886	-	-
BRASS					
polished 	-	-	-	72557	20872
euro/m	-	-	-	-	-
euro/pc	-	-	-	-	-

art. 10/ 710/ 310/ individually packed

prolevel - prolock



54/A gold anodised aluminium

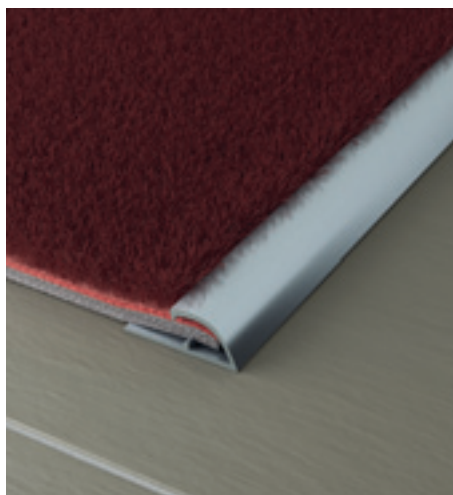

85/A silver anodised aluminium

Prolevel Thin is a transition profile for PVC flooring. To be used after the laying, it can protect the edge of the floor and it permits the connection.

Prolock is a line of profiles that could be deformed in a plastic way. It is useful as edge trim for carpet of different materials and thickness.

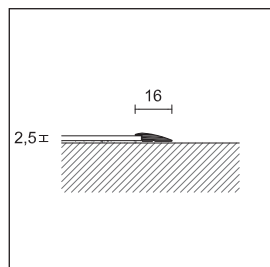

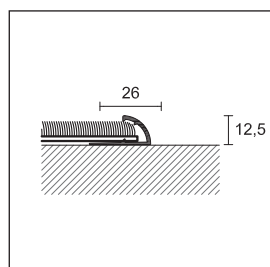

54/



85/





PROLEVEL THIN

length = 270 cm - pack 20 pcs

ART.	finishing	SF	A
ALUMINIUM			
54/	silver anodised	 72587	72617
	gold anodised	 -	72627
euro/m			

individually packed

PROLOCK

pack	20 pcs	10 pcs / blister 	
length cm	270	93	
ART.	85/	485/	
finishing	SF	A	AD
ALUMINIUM			
silver anodised	 73137	73167	21302
gold anodised	 73147	73177	21303
bronze anodised	 -	73187 *	-
euro/m			
euro/pc			
	-	-	

art. 85/ individually packed

Complete the item code with SF=undrilled,
A-AD=adhesive, (eg. 54/ undrilled becomes 54/SF)

 packaging in blister no partial packaging

* Out of production items, available till end of stock

For a single piece, see sales conditions on page 305



movement joints

A line designed to permit the expansion and contraction that materials undergo as a result of the seasonal temperature. A wide range of finishes to suit different stresses to which the coating is subjected.



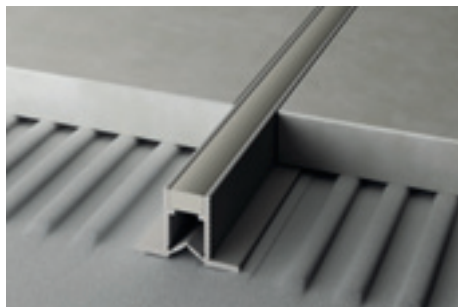

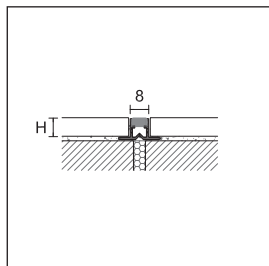

NE/10 co-extruded PVC grey+grey RAL 7035



NE/

Projoint NE is an expansion joint in co-extruded PVC. Suitable for the laying with glue, it is available in three colors and four heights and it is suitable for large areas with pedestrian traffic. Set on the joints created on the screed, it allows to absorb stresses of compression and expansion.

PROJOINT DIL

length = 270 cm		H				
ART.	finishing	8	10	12,5	15	
CO-EXTRUDED PVC						
NE/	grey+grey RAL 7035		99650	99660	99670	99680
	stone grey+stone grey RAL 7030		99653	99663	99673	99683
	cream white+cream white RAL 9001		99652	99662	-	-
pack 20 pcs						
euro/m						
pack 100 pcs						
euro/m						

no partial packaging



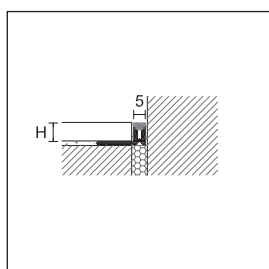

NJ/10 co-extruded PVC light grey RAL 7035



NJ/SA



Projoint NJ is an expansion joint in co-extruded PVC with perforated side flanges. Suitable for floors laid with glue, it is able to absorb tensile and compression stresses, thanks to the elastic central part. Made of PVC non-toxic and anti shock, UV resistant and it can be used indoors and outdoors. The SA version is a suitable border joint to connect a floor with a coating.

PROJOINT DIL

length = 270 cm - pack 20 pcs		H					
ART.	finishing	4,5	8	10	12,5	15	
CO-EXTRUDED PVC							
NJ/SA	light grey RAL 7035		99755	99751	99761	99771	99781
	stone grey RAL 7030		99756	99753	99763	99773	99783
euro/m							

no partial packaging - SA = without flange

PROJOINT DIL

length = 270 cm - pack 20 pcs		H					
ART.	finishing	4,5	8	10	12,5	15	
CO-EXTRUDED PVC							
NJ/	light grey RAL 7035		99757	99750	99760	99770	99780
	stone grey RAL 7030		99758	99752	99762	99772	99782
euro/m							

no partial packaging

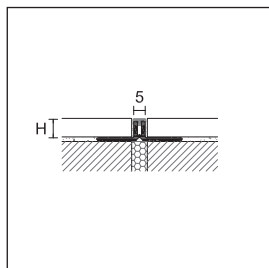

NJ/

Complete the article code with H measure (eg. NE/ with H=8 becomes NE/8)

For a single piece, see sales conditions on page 305

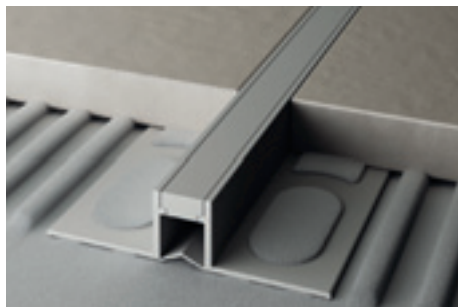

NL/10 co-extruded PVC grey + grey RAL 7035

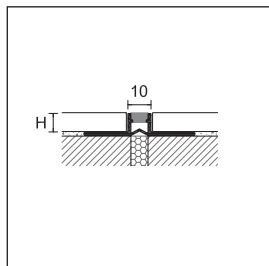

NL/

Projoint NL is an expansion joint in co-extruded PVC perforated with perforated side flanges. Suitable for floors or marble laid with glue, of a thickness between 8 and 20 mm, it is able to absorb tensile and compression stresses thanks to the elastic central part. It is suitable for both pedestrian traffic and light driveway (car and transpallet). Made of PVC non-toxic and anti shock, UV resistant and it can be used indoors and outdoors.

PROJOINT DIL

length = 270 cm - pack 20 pcs		H					
ART.	finishing	8	10	12,5	15	20	
CO-EXTRUDED PVC							
NL/	grey+grey RAL 7035		99700	99710	99720	-	-
	stone grey+ stone grey RAL 7030		99704	99714	99724	99734	99744
	white+white		99702	99712	99722	-	-
	black+black RAL 9005		99703	99713	99723	-	-
euro/m							

no partial packaging

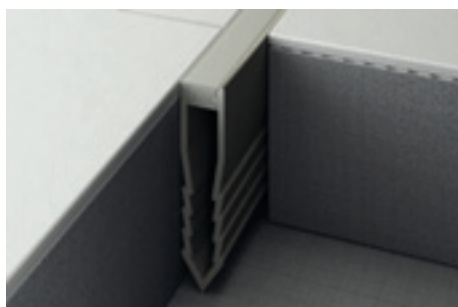

NF/45 co-extruded PVC grey + grey RAL 7035

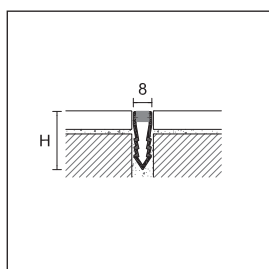

NF/

Projoint NF is an expansion joint in co-extruded PVC for the laying with mortar. Available in three colors and three heights, it is suitable to divide large areas with pedestrian traffic. It allows to absorb compressive and expansion stresses.

PROJOINT DIL

length = 270 cm		H			
ART.	finishing	25	35	45	
CO-EXTRUDED PVC					
NF/	grey+grey RAL 7035		99800	99810	99820
	stone grey+ stone grey RAL 7030		99803	99813	99823
	cream white+cream white RAL 9001		99802	99812	-
pack 20 pcs					
euro/m					
pack 40 pcs					
euro/m					
-					
pack 50 pcs					
euro/m					
-					
pack 80 pcs					
euro/m					
-					

no partial packaging



NAN/10 natural aluminium + stone grey rubber

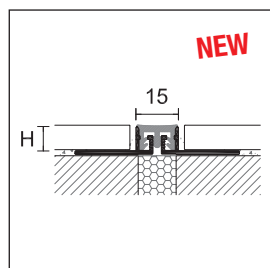

NAN/

Projoint DIL NAN is a new expansion joint in aluminium, with an interchangeable insert in elastic vinyl resin, characterized by a reduced section of 15 mm that makes it less visible. The structure of the joint allows to protect the edge of the tile and is able to withstand high traffic, both pedestrian and vehicular.

PROJOINT DIL

length = 270 cm - pack 10 pcs H

ART.	finishing	10	12,5	15
------	-----------	----	------	----

ALUMINIUM

NAN/	natural aluminium + grey RAL 7035 rubber		99974	99975	99976
	natural aluminium + stone grey RAL 7030 rubber		99977	99978	99979

euro/m

individually packed - NAN/ available with black rubber upon request, minimum order 100 pcs

SPARE INSERT FOR NAN/

length= 270 cm - pack 20 pcs

ART.	finishing		
------	-----------	--	--

GM/I	grey RAL 7035		99993
	stone grey RAL 7030		99989

euro/m



NPAN/10 natural aluminium + stone grey rubber

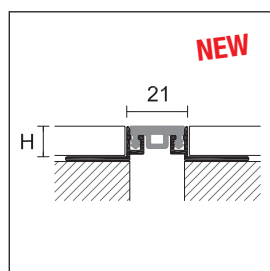

NPAN/

Projoint DIL NPAN is a new expansion joint in aluminium, with an interchangeable insert in elastic vinyl resin, characterized by a reduced section of 21 mm that makes it less visible. The structure of the joint allows to protect the edge of the tile and is able to withstand high traffic, both pedestrian and vehicular.

PROJOINT DIL

length = 270 cm - pack 10 pcs H

ART.	finishing	10	12,5	15
------	-----------	----	------	----

ALUMINIUM

NPAN/	natural aluminium + stone grey RAL 7030 rubber		99984	99985	99986
-------	--	--	-------	-------	-------

euro/m

individually packed - NPAN/ available with black rubber upon request, minimum order 100 pcs

SPARE INSERT FOR NPAN/

length= 270 cm - pack 20 pcs

ART.	finishing		
------	-----------	--	--

NEW GMP/I	stone grey RAL 7030		99988
-----------	---------------------	--	-------

euro/m

Complete the article code with H measure (for example NAN/ for H=10 becomes NAN/10)

For a single piece, see sales conditions on page 305



NIN/10 stainless steel + stone grey rubber

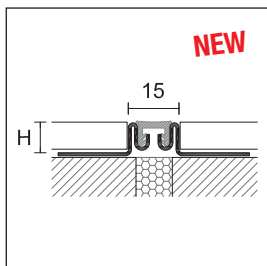

NIN/

Projoint DIL NIN is a new expansion joint in stainless steel, with an interchangeable insert in elastic vinyl resin, characterized by a reduced section of 15 mm. The structure of the joint allows to protect the edge of the tile and is able to withstand heavy traffic, both pedestrian and vehicular (forklifts, transpallets and cars).

PROJOINT DIL

length = 270 cm - pack 5 pcs H

ART.	finishing	10	12,5	15	20
------	-----------	----	------	----	----

STAINLESS STEEL

NIN/	stainless steel AISI 304 DIN 1.4301 + grey RAL 7035 rubber		99915	99916	99917	99918
	stainless steel AISI 304 DIN 1.4301 + stone grey RAL 7030 rubber		99925	99926	99927	99928
<i>euro/m</i>						

individually packed - NIN/ available with black rubber upon request, minimum order 100 pcs

SPARE INSERT FOR NIN/

length= 270 cm - pack 20 pcs

ART.	finishing		
------	-----------	--	--

GM/10	grey RAL 7035		99998
	stone grey RAL 7030		99999
<i>euro/m</i>			



NTA/10 natural aluminium + EPDM grey polishable RAL 7046

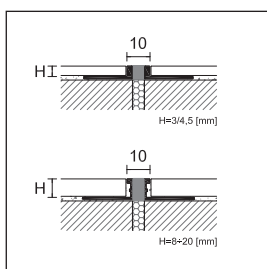

NTA/
NTO/

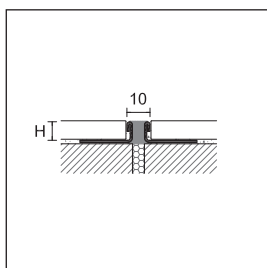

NTI/

Projoint NTA/, NTI/ e NTO/ sono giunti di dilatazione per posa a colla con sezione interna in EPDM vulcanizzato. La struttura in metallo resiste agevolmente al passaggio frequente pedonale e veicolare (carrelli elevatori, transpallet e autovetture).

PROJOINT DIL

length = 270 cm - pack 10 pcs H

ART.	finishing	3	4,5	8	10	12,5	15	20
------	-----------	---	-----	---	----	------	----	----

ALUMINIUM

NTA/	natural aluminium + EPDM grey polishable RAL 7046		99421	99425	99441	99445	99449	99453	99457
	natural aluminium + EPDM black polishable RAL 9005		99422	99426	99442	99444	99450	99454	99458
	<i>euro/m</i>								

NTI/	natural aluminium + EPDM bahama polishable RAL 10070		99427	99428	-	-	-	-	-
	natural aluminium + EPDM brown polishable RAL 10071		99429	99430	-	-	-	-	-
	<i>euro/m</i>								

PROJOINT DIL

length = 270 cm - pack 10 pcs

ART.	finishing	3	4,5	8	10	12,5	15	20
------	-----------	---	-----	---	----	------	----	----

STAINLESS STEEL

NTI/	stainless steel AISI 304 DIN 1.4301 + EPDM grey RAL 7046		99471	99475	99481	99485	99489	99493	99497
	stainless steel AISI 304 DIN 1.4301 + EPDM black RAL 9005		99472	99474	99482	99486	99490	-	-
<i>euro/m</i>									

NTI/	stainless steel AISI 304 DIN 1.4301 + EPDM bahama RAL 10070		99431	99432	-	-	-	-	-
	stainless steel AISI 304 DIN 1.4301 + EPDM brown RAL 10071		99433	99434	-	-	-	-	-
<i>euro/m</i>									

PROJOINT DIL

length = 270 cm - pack 10 pcs H

ART.	finishing	3	4,5	8	10	12,5	15	20
------	-----------	---	-----	---	----	------	----	----

BRASS

NTO/	natural brass + EPDM grey polishable RAL 7046		-	-	99401	99405	99409	99413	99417
<i>euro/m</i>									

art. NTO/15 and NTO/20 pack 5 pcs

Complete the article code with H measure (for example NIN/ for H=10 becomes NIN/10)

For a single piece, see sales conditions on page 305



NZA/10 natural aluminium

Projoint NZA is an expansion joint in natural aluminium or silver anodised consisting of two interlocking and sliding profiles. Suitable for ceramic floors subjected to intense traffic, it ensures a high resistance to loads and high traffic both pedestrian and vehicular (forklifts, transpallet and cars).

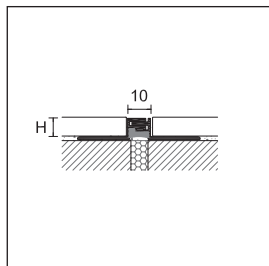

NZA/

PROJOINT DIL

length = 270 cm - pack 20 pcs		H				
ART.	finishing	3	5	8	10	12,5
ALUMINIUM						
NZA/	natural aluminium	-	-	99910	99912	99914
	<i>euro/m</i>	-	-			
NZA/	silver anodised	99300	99320	-	-	-
	<i>euro/m</i>			-	-	-

individually packed



NZS/10 silver anodised aluminium



NZS/A/40 silver anodised aluminium

Projoint NZS is an expansion joint in aluminium with high absorption. Thanks to the 2 interlocking parts, the joint can absorb movements of +/- 5 mm with articulated flins that permit tridimensional movements. The structure of the joint protects the edge of the tile, and it bears the pedestrian and vehicular passage. NZS is also available as a joint cover (when tiles are already laid), NZS/A, or side joint for industrial buildings, NZS/L.

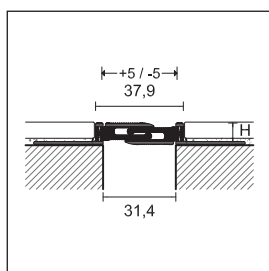

NZS/

PROJOINT DIL

length = 270 cm - pack 5 pcs		H			
ART.	finishing	10	12,5	15	20
ALUMINIUM					
NZS/	silver anodised	99880	99881	99882	99883
	<i>euro/m</i>				

PROJOINT DIL

length = 270 cm - pack 5 pcs		H
ART.	finishing	8
ALUMINIUM		
NZS/A/40	silver anodised	99885
	<i>euro/m</i>	

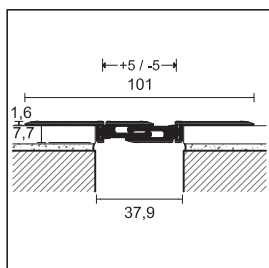

NZS/A/40

PROJOINT DIL

length = 270 cm - pack 5 pcs		H			
ART.	finishing	10	12,5	15	20
ALUMINIUM					
NZS/L/	silver anodised	99890	99891	99892	99893
	<i>euro/m</i>				

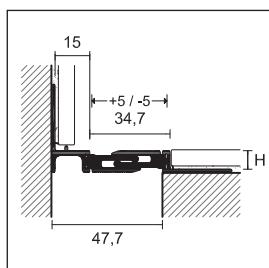

NZS/L/

Complete the article code with H measure (eg. NZA/ with H=8 becomes NZA/8)

For a single piece, see sales conditions on page 305



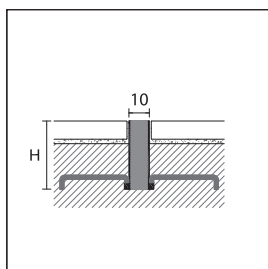

STI/40 stainless steel AISI 304 DIN 1.4301 + EPDM grey polishable RAL 7046

Projoint STA/STI/STO are expansion joints for the division of floors laid with mortar, with inner section in vulcanized EPDM. The metal structure easily stands up to the recurring pedestrian and vehicular traffic (forklift trucks, transpallets and cars). It is particularly suitable for shopping malls and frequent passages of loads.



STA/
STI/
STO/

PROJOINT DIL

length = 250 cm - pack 10 pcs		H		
ART.	finishing	30	40	50
ALUMINIUM				
STA/	natural aluminium + EPDM grey polishable RAL 7046 	99581	99585	99589
STAINLESS STEEL				
STI/	stainless steel AISI 304 DIN 1.4301 + EPDM grey polishable RAL 7046 	99621	99625	99629
BRASS				
STO/	natural brass + EPDM grey polishable RAL 7046 	99541 *	99545 *	99549 *

Complete the article code with H measure (for example STA/ for H=8 becomes STA/8)

Upon request, we can make different measures and colours for articles STA/, STI/ and STO. Please contact our sales department

* Out of production items, available till end of stock

For a single piece, see sales conditions on page 305

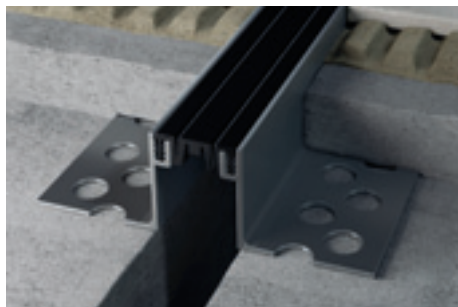

PBE/30 natural aluminium + striated black rubber

Projoint DIL PBE is a structural joint composed of two L-shaped profiles in natural aluminium and an expanding part in interchangeable plasticized PVC, available in black or grey. The two L-shaped profiles have drilled bases to allow the mechanical fixing with screws to the underlying structure.

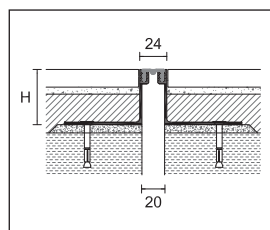

PBE/20 smooth rubber

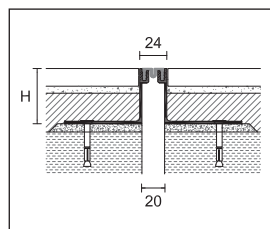

PBE/20 striated rubber

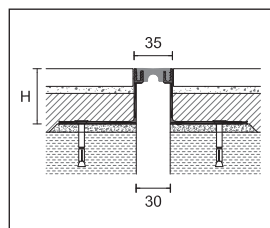

PBE/30 smooth rubber

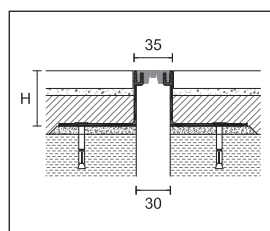

PBE/30 striated rubber

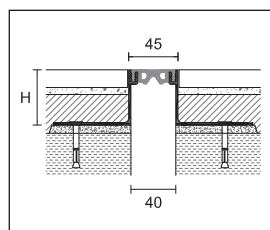

PBE/40 smooth rubber

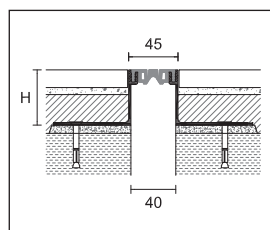

PBE/40 striated rubber

NEW PROJOINT DIL

length = 300 cm - pack 5 pcs		H					
ART.	finishing	14	24	42	50	82	
ALUMINIUM							
	natural aluminium + smooth grey rubber		99321	99322	99323	99324	99325
	natural aluminium + smooth black rubber		99326	99327	99328	99329	99330
PBE/20/ euro/m							
	natural aluminium + striated grey rubber		99331	99332	99333	99334	99335
	natural aluminium + striated black rubber		99336	99337	99338	99339	99340

no partial packaging - profiles are provided with accessories for mechanical fixing



smooth rubber



striated rubber

NEW PROJOINT DIL

length = 300 cm - pack 5 pcs		H					
ART.	finishing	14	24	42	50	82	
ALUMINIUM							
	natural aluminium + smooth grey rubber		99341	99342	99343	99344	99345
	natural aluminium + smooth black rubber		99346	99347	99348	99349	99350
PBE/30/ euro/m							
	natural aluminium + striated grey rubber		99351	99352	99353	99354	99355
	natural aluminium + striated black rubber		99356	99357	99358	99359	99360

no partial packaging - profiles are provided with accessories for mechanical fixing



smooth rubber



striated rubber

NEW PROJOINT DIL

length = 300 cm - pack 5 pcs		H					
ART.	finishing	14	24	42	50	82	
ALUMINIUM							
	natural aluminium + smooth grey rubber		99361	99362	99363	99364	99365
	natural aluminium + smooth black rubber		99366	99367	99368	99369	99370
PBE/40/ euro/m							
	natural aluminium + striated grey rubber		99371	99372	99373	99374	99375
	natural aluminium + striated black rubber		99376	99377	99378	99379	99380

no partial packaging - profiles are provided with accessories for mechanical fixing



smooth rubber



striated rubber

We suggest the use of the black insert.

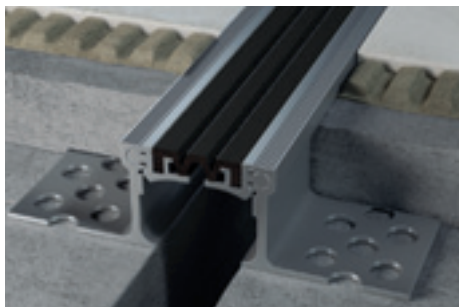

PBH/65/ natural aluminium + black EPDM insert

Projoint DIL PBH and PAS are two structural joints composed of two L-shaped profiles in natural aluminium and an expanding part in interchangeable EPDM, available in black or grey. The two L-shaped profiles have drilled bases to allow the mechanical fixing with screws to the underlying structure and are designed to withstand structural movements of big buildings.

Projoint DIL PHDE is a structural joint composed of two interlocking and sliding profiles in natural aluminium. The two profiles have drilled bases to allow the mechanical fixing with screws to the underlying structure and are designed to withstand structural movements of big buildings.

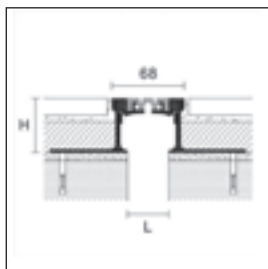

PBH/65

PROJOINT DIL

length = 300 cm - pack 2 pcs

		H			
ART.	finishing	18	35	50	80
ALUMINIUM		L=50	L=40	L=40	L=40
NEW PBH/65/	natural aluminium + grey EPDM insert	99500	99501	99502	99503
	natural aluminium + black EPDM insert	99504	99505	99506	99507
<i>euro/m</i>					

no partial packaging - profiles are provided with accessories for mechanical fixing

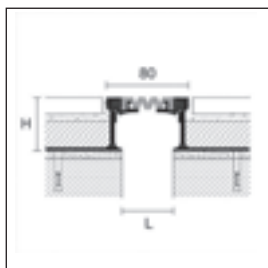

PBH/75

PROJOINT DIL

length = 300 cm - pack 2 pcs

		H			
ART.	finishing	18	35	50	80
ALUMINIUM		L=60	L=50	L=50	L=50
NEW PBH/75/	natural aluminium + grey EPDM insert	99508	99509	99510	99511
	natural aluminium + black EPDM insert	99512	99513	99514	99515
<i>euro/m</i>					

no partial packaging - profiles are provided with accessories for mechanical fixing

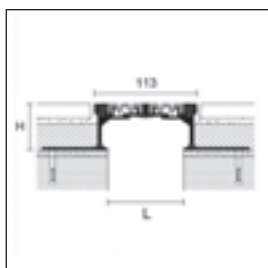

PAS/105

PROJOINT DIL

length = 300 cm - pack 2 pcs

		H			
ART.	finishing	18	35	50	80
ALUMINIUM		L=95	L=85	L=85	L=85
NEW PAS/105/	natural aluminium + grey EPDM insert	99516	99517	99518	99519
	natural aluminium + black EPDM insert	99520	99521	99522	99523
<i>euro/m</i>					

no partial packaging - profiles are provided with accessories for mechanical fixing

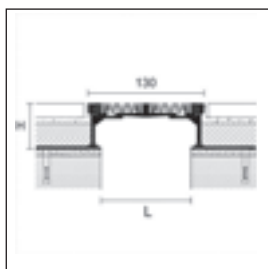

PAS/125

PROJOINT DIL

length = 300 cm - pack 2 pcs

		H			
ART.	finishing	18	35	50	80
ALUMINIUM		L=111	L=100	L=100	L=100
NEW PAS/125/	natural aluminium + grey EPDM insert	99524	99525	99526	99527
	natural aluminium + black EPDM insert	99528	99529	99530	99531
<i>euro/m</i>					

no partial packaging - profiles are provided with accessories for mechanical fixing

We suggest the use of the black insert.

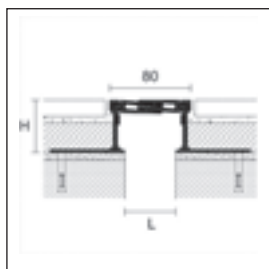

PHDE/80

PROJOINT DIL

length = 300 cm - pack 2 pcs		H			
ART.	finishing	18	35	50	80
ALUMINIUM		L=60	L=50	L=50	L=50
NEW	PHDE/80/ natural aluminium	99590	99591	99592	99593
<i>euro/m</i>					

no partial packaging - profiles are provided with accessories for mechanical fixing

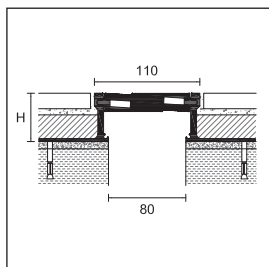

PHDE/110

PROJOINT DIL

length = 300 cm - pack 2 pcs		H			
ART.	finishing			50	80
ALUMINIUM					
NEW	PHDE/110/ natural aluminium			99594	99595
<i>euro/m</i>					

no partial packaging - profiles are provided with accessories for mechanical fixing

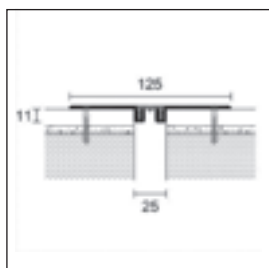

PFFE/20

PROJOINT DIL

length = 300 cm - pack 5 pcs		H			
ART.	finishing				
ALUMINIUM					
	natural aluminium + smooth grey rubber			99596	
	natural aluminium + smooth black rubber			99597	
NEW	PFFE/20/ <i>euro/m</i>				
	natural aluminium + striated grey rubber			99598	
	natural aluminium + striated black rubber			99599	
<i>euro/m</i>					

no partial packaging - profiles are provided with accessories for mechanical fixing



smooth rubber striated rubber

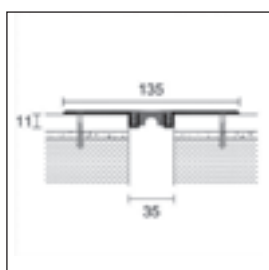

PFFE/30

PROJOINT DIL

length = 300 cm - pack 5 pcs		H			
ART.	finishing				
ALUMINIUM					
	natural aluminium + smooth grey rubber			99600	
	natural aluminium + smooth black rubber			99601	
NEW	PFFE/30/ <i>euro/m</i>				
	natural aluminium + striated grey rubber			99602	
	natural aluminium + striated black rubber			99603	
<i>euro/m</i>					

no partial packaging - profiles are provided with accessories for mechanical fixing



smooth rubber striated rubber

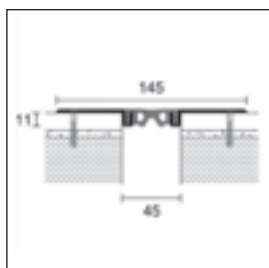

PFFE/40

PROJOINT DIL

length = 300 cm - pack 5 pcs		H			
ART.	finishing				
ALUMINIUM					
	natural aluminium + smooth grey rubber			99604	
	natural aluminium + smooth black rubber			99605	
NEW	PFFE/40/ <i>euro/m</i>				
	natural aluminium + striated grey rubber			99606	
	natural aluminium + striated black rubber			99607	
<i>euro/m</i>					

no partial packaging - profiles are provided with accessories for mechanical fixing



smooth rubber striated rubber

We suggest the use of the black insert.

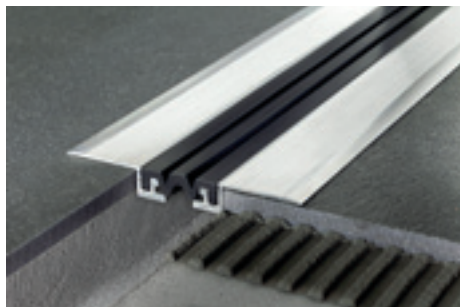

GJF/40 natural aluminium + EPDM black RAL 9005



GJA/70 silver anodised aluminium

Procover GJF/40 and GJF/50 are structural aluminium joint covers designed to withstand tensile and compressive transverse movements of large buildings. They withstand pedestrian and vehicular with rubber wheels (cars) traffic. GJA, GWA are flat joint covering profiles in aluminium, suitable to cover structural movements of expansion or compression of two different structures. Available also in the corner version.

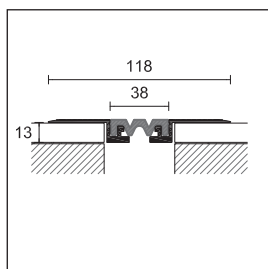

GJF/40

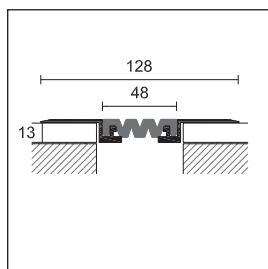

GJF/50

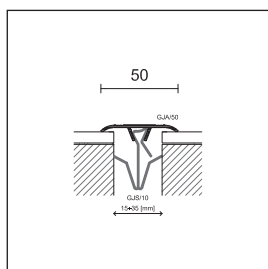

GJA/50

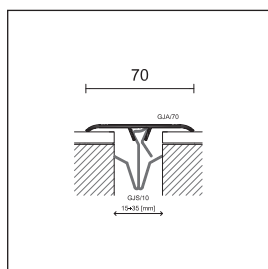

GJA/70

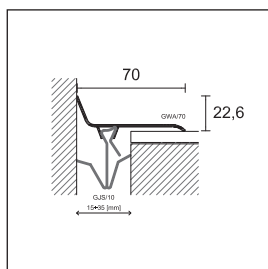

GWA/70

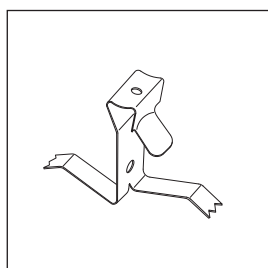

GJS/10

PROCOVER FLEX

		length = 400 cm - pack 5 pcs		L
ART.	finishing	40	50	
ALUMINIUM				
GJF/	natural aluminium + EPDM black insert RAL 9005		74490	74492
	<i>euro/m</i>			

SPARE INSERT

		length = 400 cm		L
ART.	finishing	40	50	
ALUMINIUM				
GM/	EPDM black RAL 9005		74491	74493
	<i>euro/m</i>			

PROCOVER FIX

		length = 300 cm - pack 10 pcs		L
ART.	finishing	50	70	
ALUMINIUM				
GJA/	silver anodised		74550	74610
	<i>euro/m</i>			
GWA/	silver anodised		-	74552
	<i>euro/m</i>			

SPRING CLIP

		from 15 to 35 mm - pack 50 pcs	
STAINLESS STEEL			
GJS/10	harmonic stainless steel		74730
	<i>euro/pc</i>		

Complete the article code with L measure (eg. GJF/ with L=40 becomes GJF/40)

For a single piece, see sales conditions on page 305

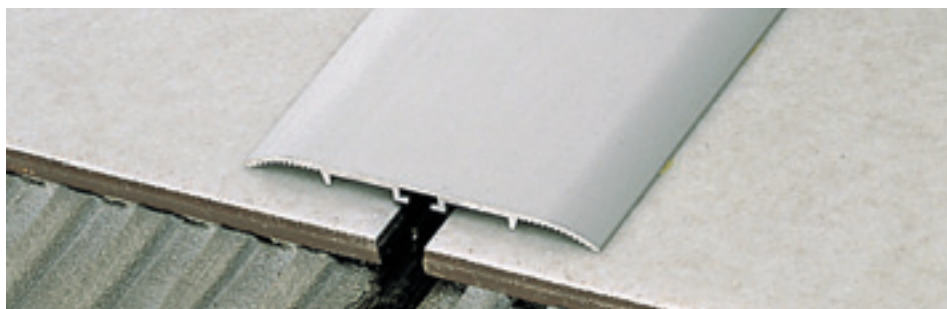

G/80/A silver anodised aluminium

Procover G in anodized aluminium are joint covering profiles, suitable for creating continuity on structures with continuous bays. These joint coverings are supplied with adhesive or are fixed with screws and dowels. In this case it is perforated laterally, and fixed only to one structure allowing the free sliding over the other.

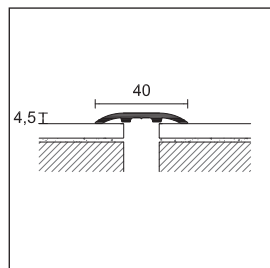

G/40/

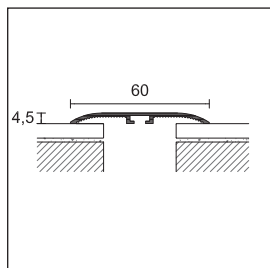

G/60/

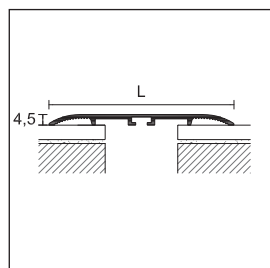

G/80/100/



GB/660/F silver anodised aluminium

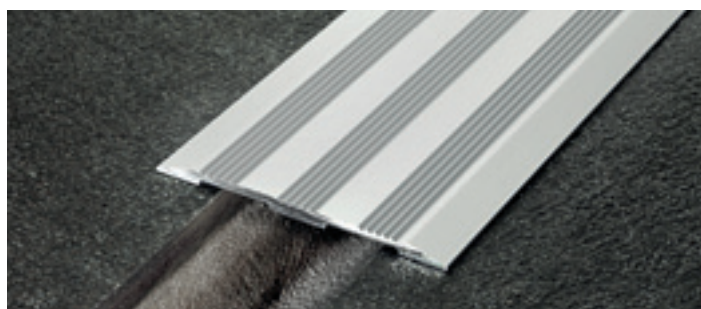

GR/80/SF silver anodised aluminium

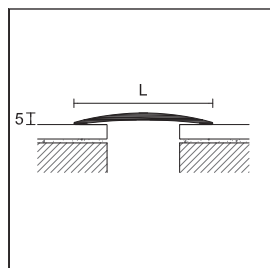

GB/660/F
GB/880/F

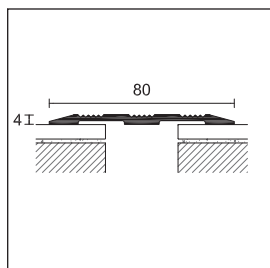

GR/80/SF

PROCOVER

pack	20 pcs	20 pcs	6 pcs/blister	20 pcs	10 pcs
length cm	300	300	100	300	300
ART.	G/40/	G/60/	G/460/	G/80/	G/100/
finishing	A	SF A	AD	SF A	SF A
ALUMINIUM					
silver anodised	74528	74558 74588	21982	74618 74648	74678 74708
euro/m			-		
euro/pc	-	-	-	-	-

art. G/40, G/60, G/80, G/100 individually packed

PROCOVER

length = 270 cm - pack 10 pcs	L		L
width	60	80	80
ART.	GB/660/	GB/880/	GR/80/
finishing	F	F	SF
ALUMINIUM			
silver anodised	71840	71850	71855
gold anodised	71842 *	71852 *	-
euro/m			

individually packed

Complete the article code with A-AD=adhesive, SF=undrilled (for example G/40/ adhesive becomes G/40/A)

📦 packaging in blister no partial packaging

* Out of production items, available till end of stock

For a single piece, see sales conditions on page 305

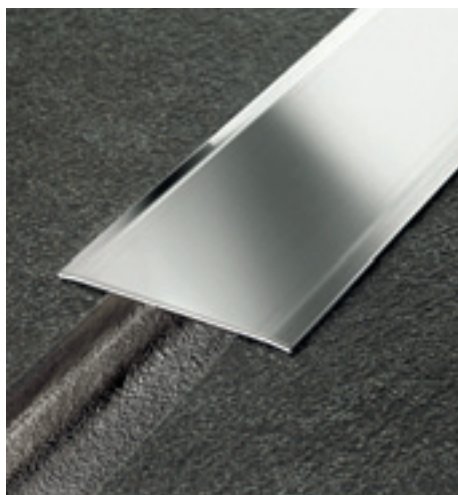

760/SF polished stainless steel AISI430-DIN 1.4016

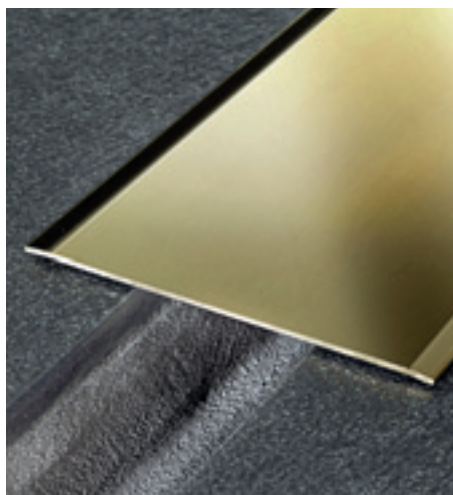

0100/A polished brass

Procover G in stainless steel and polished brass are joint covering profiles, suitable for creating continuity on structures with continuous bays. These joint coverings are supplied with adhesive or are fixed with screws and dowels. In this case it is perforated laterally, and fixed only to one structure allowing the free sliding over the other. In these versions they are suitable even to vehicular traffic.

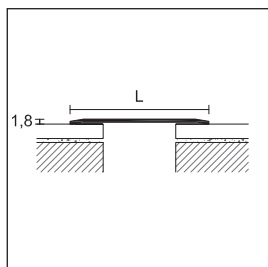

PROCOVER												
	10 pcs		6 pcs / blister		10 pcs		6 pcs / blister		5 pcs		3 pcs / blister	
length cm	300		100		300		100		300		100	
width mm	50		50		60		60		80		80	
thickness	12/10											
ART.	750/		4750/		760/		4760/		780/		4780/	
finishing	SF	A	AD	SF	A	AD	SF	A	AD	SF	A	
STAINLESS STEEL												
polished stainless steel AISI 430 - DIN 1.4016		74818	74828	22090	74838	74848	40531	74858	74868	40553	74878	74888
euro/m			-				-			-		
euro/pc		-	-		-	-		-	-		-	-

art. 750/, 760/, 780/, 7100/ individually packed

PROCOVER												
	10 pcs		6 pcs / blister		5 pcs		6 pcs / blister		5 pcs		3 pcs / blister	
length cm	300		100		300		100		300		100	
width mm	50		50		60		60		80		80	
thickness	13/10											
ART.	050/		4050/		060/		4060/		080/		4080/	
finishing	SF	A	AD	SF	A	AD	SF	A	AD	SF	A	
BRASS												
polished		74738	74748	22050	74758	74768	40504	74778*	74788	40512	74798	74808
euro/m				-			-			-		
euro/pc		-	-		-	-		-	-		-	-

art. 050/, 060/, 080/, 0100/ individually packed

Complete the article code with A-AD=adhesive, SF=undrilled (eg. 050/ adhesive becomes 050/A)

packaging in blister no partial packaging

* Out of production items, available till end of stock

For a single piece, see sales conditions on page 305





waterproofing, drainage, uncoupling

A line of waterproofing, uncoupling and draining membranes for the laying of ceramic floors and coverings of bathrooms, balconies, terraces and problematic supports.





WPstop system

WPstop is a waterproof membrane in polyethylene with a textile in polypropylene in both sides in order to facilitate the grip of the adhesive, thus ensuring a high adhesion to the support. It is particularly suitable for the waterproofing of floors and tiled walls of bathrooms. For the application, we recommend the use of tiles adhesive C2, while in the joints between sheets and accessories we recommend the use of a polymer sealant MS (type PP/96).



rolls



strips

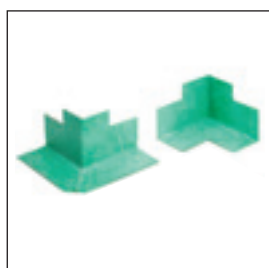

corners



colar

WPSTOP

ART.	measures	
PR30	roll 1 m height 30 mt length - pack 1 roll	19900
	<i>euro/m</i>	
PR5	roll 1 m height 5 mt length - pack 6 rolls	19902
	<i>euro/m</i>	
PB30	stripe 14 cm height 30 mt length - pack 1 roll	19910
	<i>euro/m</i>	
PB5	stripe 14 cm height 5 mt length - pack 6 rolls	19912
	<i>euro/m</i>	
PAE	outside corners - pack 10 pcs	19920
	<i>euro/pc</i>	
PAI	inside corners - pack 10 pcs	19922
	<i>euro/pc</i>	
PF12	colar cm 12x12 - pack 10 pcs	19930
	<i>euro/pc</i>	

no partial packaging

INSTRUCTIONS

Store in a cool and dry place, avoiding direct exposure to sunlight and heat sources.

Please refer to the technical data sheet before the installation. For special installations, please contact our technical department.



WPstop 3

WPstop 3 is an uncoupling, waterproofing and anti-fracture membrane for indoor and outdoor use, particularly recommended before the laying of floors of bathrooms, balconies, terraces and problematic supports. We recommend the use of a tile adhesive C2 S1 for the application of the membranes and a MS polymer-based adhesive (type PP/96) with elastic strips art. PBE30 or PBE5 for the joints between membranes.



PWP30

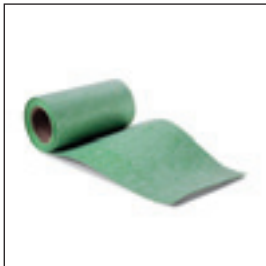

PBE30



PP/96

WPSTOP 3

ART. measures

PWP30 roll 1 m height 30 mt length - pack 8 rolls 19940
euro/m

PBE30 elastic stripe of 12 cm height and 30 m length - pack 1 roll 19945
euro/m

PBE5 elastic stripe of 12 cm height and 5 m length - pack 6 rolls 19946
euro/m

no partial packaging - PWP30 sale also in rolls

INSTRUCTIONS

Store in a cool and dry place, avoiding direct exposure to sunlight and heat sources.

Please refer to the technical data sheet before the installation. For special installations, please contact our technical department.

MS POLYMER-BASED ADHESIVE

pack 24 pcs - quantity 290 ml

ART. measures

PP/96 78301
euro/pc

For a single piece, see sales conditions on page 305

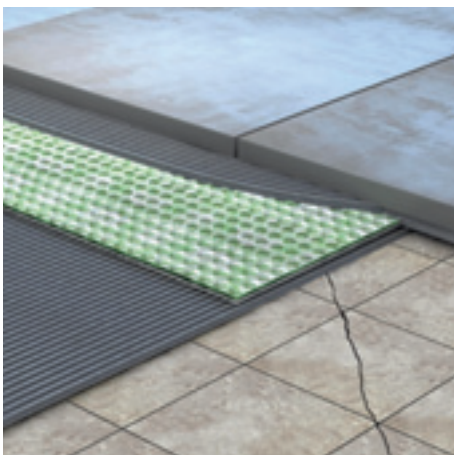

PWP30 - uncoupling

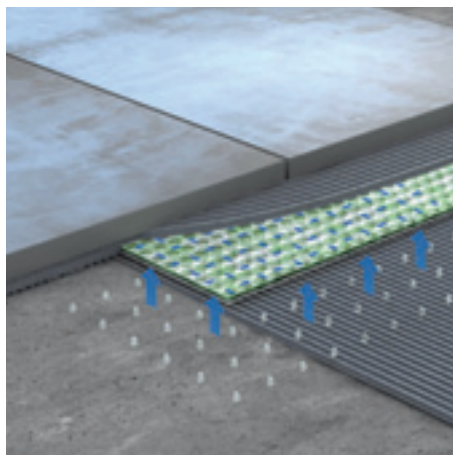

PWP30 - vapour vent

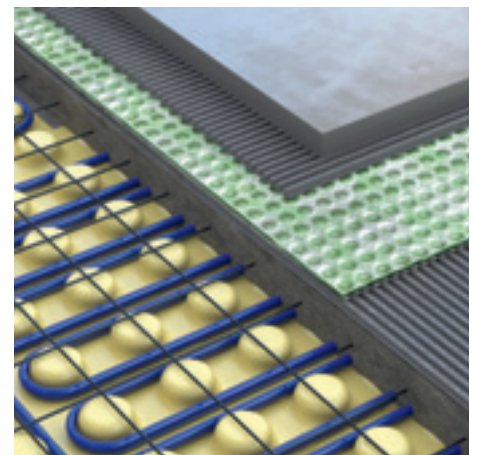

PWP30 - heated floor

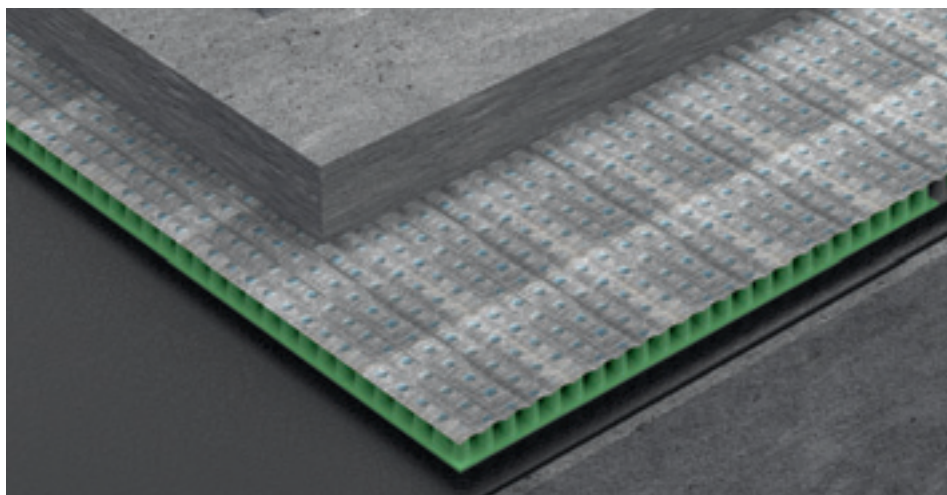

WPstop Drain 10 is a draining membrane in high-density polyethylene (HDPE) with truncated cones structure and a filtering permeable fabric on the upper side. WPstop Drain 10 complies with the regulation UNI 11493-1 which requires a protective draining layer in case of waterproofing under the screed.

WPstop Drain 10

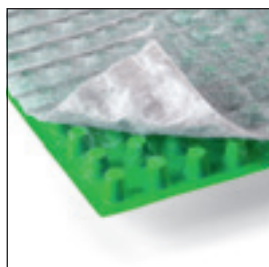

PWD12

WPSTOP DRAIN 10

ART. measures

PWD12 roll of 0,96 m height and 12,5 m length - pack 6 rolls

19950

euro/m

INSTRUCTIONS

Store in a cool and dry place, avoiding direct exposure to sunlight and heat sources.

Please refer to the technical data sheet before the installation. For special installations, please contact our technical department.

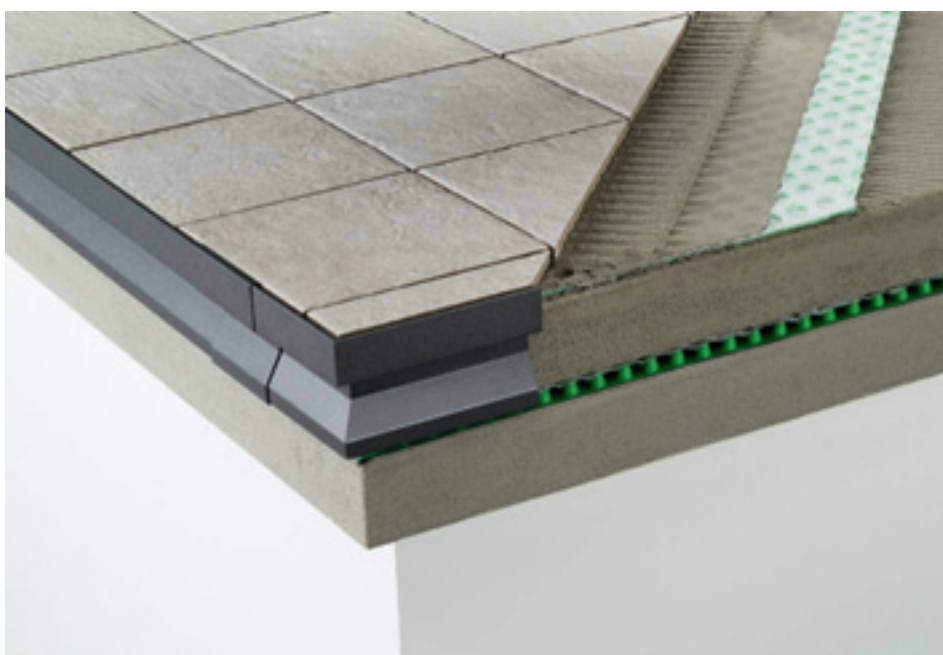

wpstop 3 + wpstop drain 10



profiles for balconies and terraces

A functional and stylish line for the protection of terraces, balconies and pavements. The effectiveness of the protection decorates and completes every architectural detail.





CPCV/55/10 colour-coated aluminium ancient grey

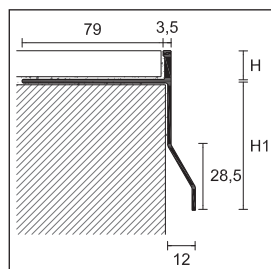

CPCV/

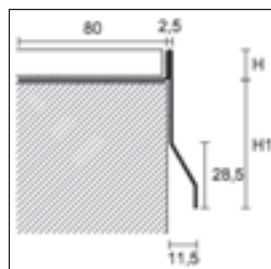

CPCI/

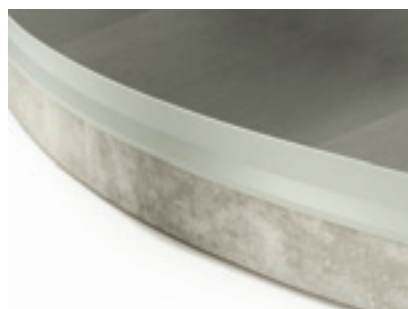

CPCVF/55/10 ash grey RAL 7038 embossed colour-coated aluminium

Protec CPCV and CPCI are a series of edge profiles for the protection and the finishing of the outside edges of terraces and balconies. Available in colour-coated aluminium and stainless steel, they have been designed with a protruding section and can be used with tiles thicknesses up to 21 mm. In addition to protecting and finishing the outside edges, they guarantee the outflow of water from the floor, avoiding the contact with the outside border.

Protec CPCV is also available in the bendable version CPCVF, provided with a special cutout that allows to bend the profile with a radius up to 1 meter.

PROTEC

length = 270 cm - pack 10 pcs		H								
		10	12,5	21	10	12,5	21	10	12,5	21
ART.		CPCV/55/			CPCV/75/			CPCV/95/		
finishing										
COLOUR-COATED ALUMINIUM										
white RAL 9003		87677	87678	-	87687	87688	-	87697	87698	-
ash grey RAL 7038		87681	87682	87660	87691	87692	87661	87701	87702	87662
ash grey RAL 7038 embossed		87713	87714	-	87715	87716	-	87717	87718	-
dark brown RAL 8019		87683	87684	-	87693	87694	-	87703	87704	-
rust		87616	87617	-	87618	87619	-	-	-	-
metal grey RAL 9006		87720	87721	-	87723	87724	-	87726	87727	-
aluminium grey RAL 9007		87750	87751	-	87753	87754	-	87756	87757	-
ancient grey		87707	87708	-	87709	87710	-	87711	87712	-
euro/m										

For different colours, please contact our sales department.

PROTEC

length = 270 cm - pack 10 pcs		H								
		10	12,5	10	12,5	10	12,5			
ART.		CPCI/55/		CPCI/75/		CPCI/95/				
finishing										
STAINLESS STEEL										
polished stainless steel AISI 304 DIN 1.4301		87671	87672	-	87673	87674	-	87675	87676	-
euro/m										

NEW **PROTEC FLEX**

length = 270 cm - pack 2 pcs		H		
		10		
ART.	finishing	CPCVF/55/		
COLOUR-COATED ALUMINIUM				
ash grey RAL 7038		87790		
ash grey RAL 7038 embossed		87791		
ancient grey		87792		
euro/m				

no partial packaging

Complete the article code with H measure (for example CPCV/55/ for H=10 becomes CPCV/55/10)

For other colours, please contact our Sales Department.

For other heights and finishes of Flex profiles, please contact our Sales Department.

For a single piece, see sales conditions on page 305

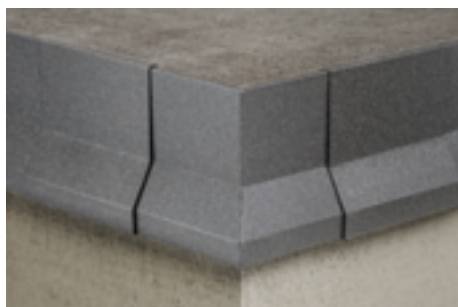

CPCV/55/E + CPCV/55/G ancient grey colour-coated aluminium

OUTSIDE CORNER 90°

		pack 5 pcs								
		H								
		10	12,5	21	10	12,5	21	10	12,5	21
ART.	finishing	CPCV/55/ /E			CPCV/75/ /E			CPCV/95/ /E		
COLOUR-COATED ALUMINIUM										
white RAL 9003		87817	87818	-	87827	87828	-	87837	87838	-
ash grey RAL 7038		87821	87822	87663	87831	87832	87664	87841	87842	87665
ash grey RAL 7038 embossed	NEW	87894	87895	-	87896	87897	-	87898	87899	-
dark brown RAL 8019		87825	87826	-	87835	87836	-	87845	87846	-
rust		87620	87621	-	87622	87623	-	-	-	-
metal grey RAL 9006		87730	87731	-	87733	87734	-	87736	87737	-
aluminium grey RAL 9007		87760	87761	-	87763	87764	-	87766	87767	-
ancient grey		87877	87878	-	87879	87880	-	87881	87882	-
euro/pc										

OUTSIDE CORNER 90°

		pack 5 pcs								
		H								
		10	12,5	10	12,5	10	12,5			
ART.	finishing	CPCI/55/ /E		CPCI/75/ /E		CPCI/95/ /E				
STAINLESS STEEL										
polished stainless steel AISI 304 DIN 1.4301		87801	87802	-	87803	87804	-	87805	87806	-
euro/pc										

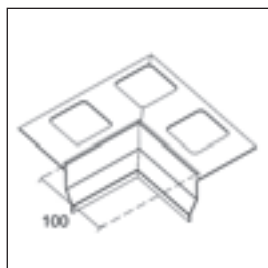

INSIDE CORNER 90°

		pack 5 pcs			
		H			
		10	12,5		
ART.	finishing	CPCV/55/ /I			
COLOUR-COATED ALUMINIUM					
ash grey RAL 7038		87890	87891	-	
ash grey RAL 7038 embossed		87807	87808	-	
ancient grey		87892	87893	-	
euro/pc					

JUNCTION

		width = 70 mm - pack 5 pcs								
		H								
		10	12,5	21	10	12,5	21	10	12,5	21
ART.	finishing	CPCV/55/ /G			CPCV/75/ /G			CPCV/95/ /G		
COLOUR-COATED ALUMINIUM										
white RAL 9003		87847	87848	-	87857	87858	-	87867	87868	-
ash grey RAL 7038		87851	87852	87666	87861	87862	87667	87871	87872	87668
ash grey RAL 7038 embossed	NEW	87748	87749	-	87758	87759	-	87768	87769	-
dark brown RAL 8019		87853	87854	-	87863	87864	-	87873	87874	-
rust		87624	87625	-	87626	87627	-	-	-	-
metal grey RAL 9006		87740	87741	-	87743	87744	-	87746	87747	-
aluminium grey RAL 9007		87770	87771	-	87773	87774	-	87776	87777	-
ancient grey		87883	87884	-	87885	87886	-	87887	87888	-
euro/pc										

no partial packaging

JUNCTION

		width = 70 mm - pack 5 pcs								
		H								
		10	12,5	10	12,5	10	12,5			
ART.	finishing	CPCI/55/ /G		CPCI/75/ /G		CPCI/95/ /G				
STAINLESS STEEL										
polished stainless steel AISI 304 DIN 1.4301		87811	87812	-	87813	87814	-	87815	87816	-
euro/pc										

no partial packaging



Protec CPCV/30/ is the new solution for old terraces. The reduced dimensions of the protruding section allow to avoid removing the perimetral balustrades in case of refurbishment.

CPCV/30/ ancient grey colour-coated aluminium

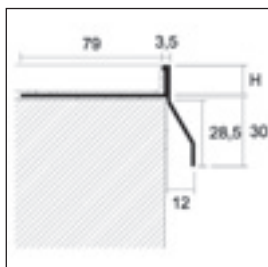

CPCV/30/

PROTEC

length = 270 cm - pack 10 pcs H

ART.	CPCV/30/10	CPCV/30/12
finishing		
COLOUR-COATED ALUMINIUM		
ash grey RAL 7038	87651	87652
ash grey RAL 7038 embossed NEW	87655	87656
ancient grey	87653	87654
euro/m		

OUTSIDE CORNER 90°

pack 5 pcs H

ART.	finishing	CPCV/30/10/E	CPCV/30/12/E
COLOUR-COATED ALUMINIUM			
ash grey RAL 7038		87780	87781
ash grey RAL 7038 embossed NEW		87784	87785
ancient grey		87782	87783
euro/pc			

JUNCTION

width = 70 mm - pack 5 pcs H

ART.	finishing	CPCV/30/10/G	CPCV/30/12/G
COLOUR-COATED ALUMINIUM			
ash grey RAL 7038		87631	87632
ash grey RAL 7038 embossed NEW		87635	87636
ancient grey		87633	87634
euro/pc			

no partial packaging

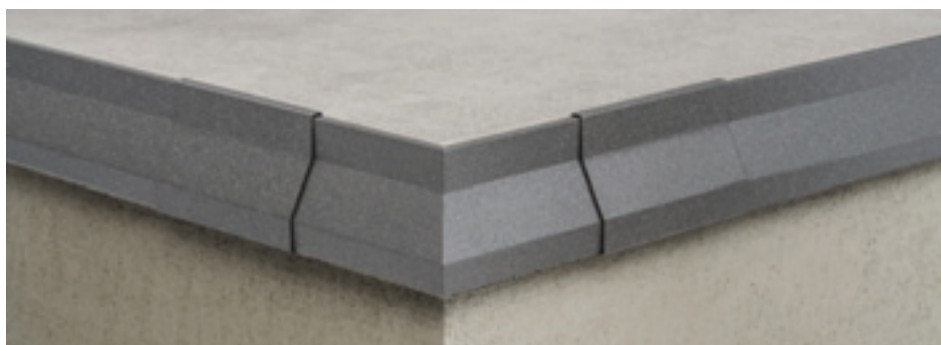

CPCV/30/ /E colour-coated aluminium ancient grey

Complete the article code with H measure (for example CPCV/30/ for H=10 becomes CPCV/30/10)

For a single piece, see sales conditions on page 305



CPHA/10 silver anodised aluminium

Protec CPHA is an edge profile in anodised and colour-coated aluminium for terraces, balconies and sidewalks. The shape allows the outflow of water, avoiding the direct contact with the screed. Installed along the perimeter, it allows to outline the ceramic tiles and to protect the border in many fields of use. It can be used with tiles thicknesses up to 21 mm.

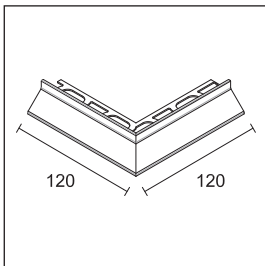
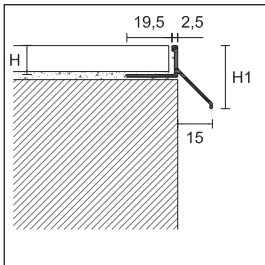

PROTEC

length = 270 cm - pack 10 pcs

		H (H1)				
ART.	finishing	8 (23)	10 (25)	12,5 (27)	21 (36)	
ALUMINIUM						
CPHA/	silver anodised	87599	87600	87601	87602	
		<i>euro/m</i>				
COLOUR-COATED ALUMINIUM						
	ash grey RAL 7038	NEW	-	87606	87607	87608
CPHV/	ash grey RAL 7038 embossed	NEW	-	87637	87638	-
	ancient grey		-	87639	87640	-
		<i>euro/m</i>				

white RAL 9003, dark brown RAL 8019, metal grey RAL 9006, aluminium grey RAL 9007 and ancient grey with a minimum of 270 meters, on request, without surcharge. For different colours, please contact our Sales Department.

OUTSIDE CORNER A 90°

dimension = 12x12 cm - pack 5 pcs

		H (H1)				
ART.	finishing	8 (23)	10 (25)	12,5 (27)	21 (36)	
ALUMINIUM						
NEW CPHA/	silver anodised		87564	87565	87597	87598
		<i>euro/pc</i>				
COLOUR-COATED ALUMINIUM						
	ash grey RAL 7038		-	87603	87604	-
NEW CPHV/	ash grey RAL 7038 embossed		-	87641	87642	-
	ancient grey		-	87643	87644	-
		<i>euro/pc</i>				

Complete the article code with H measure (for example CPHA/ for H=10 becomes CPHA/10)

For a single piece, see sales conditions on page 305



CPHA/10E silver anodised aluminium

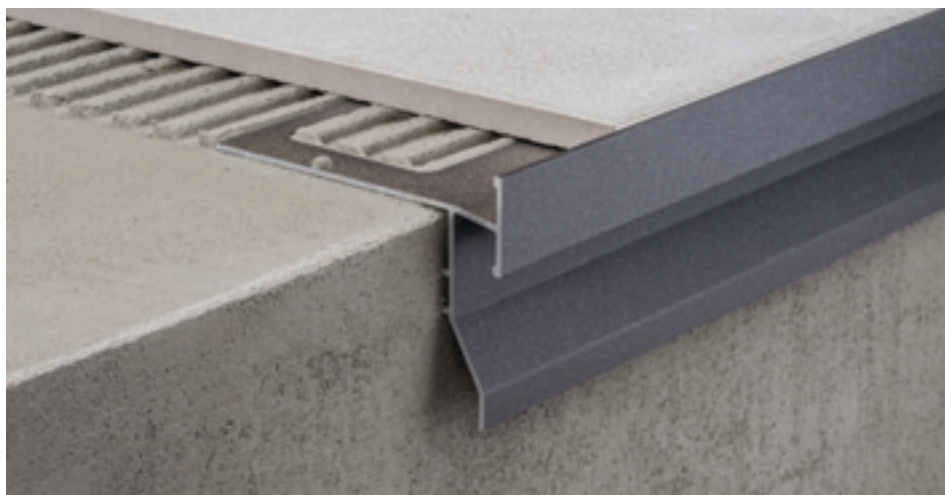

Protec CPGV is an edge profile for the protection and finishing of the outside edges of terraces and balconies. This model has a vertical part that covers the floor border and allows the outflow of water from the tiled floor; the holes in the protruding part allow a further outflow of the water that seeps down the tiles. This technical solution and the consequent drainage reduce the problems of freezing and thawing and the unsightly efflorescences on the tiles grouts. It can be used with tiles thicknesses up to 12,5 mm.

CPGV/55/10 Ancient grey colour-coated aluminium

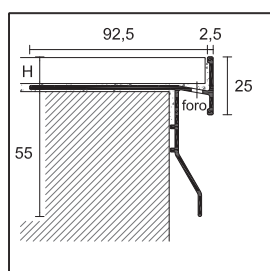

CPGV/55/

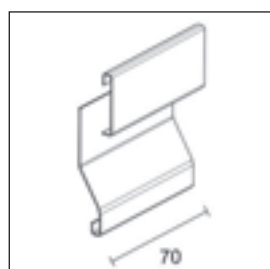
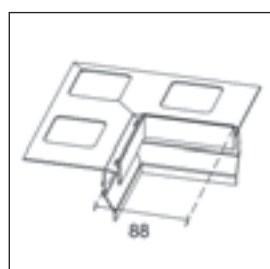
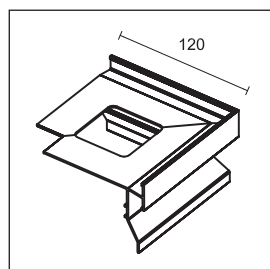

PROTEC

length = 270 cm - pack 10 pcs H

ART.	finishing	H	
		10	12,5
		CPGV/55/10	CPGV/55/12
COLOUR-COATED ALUMINIUM			
ash grey RAL 7038		87580	87581
ash grey RAL 7038 embossed		87578	87579
metal grey RAL 9006		87590	87591
ancient grey		87582	87583
white ST NEW		87547	87548
<i>euro/m</i>			

white RAL 9003, dark brown RAL 8019 and aluminium grey RAL 9007 with a minimum of 540 meters, on request, without surcharge. For lower quantities or different colours, please contact our sales department.

OUTSIDE CORNER 90°

pack 5 pcs H

ART.	finishing	H	
		10	12,5
		CPGV/55/10/E	CPGV/55/12/E
COLOUR-COATED ALUMINIUM			
ash grey RAL 7038		87584	87585
ash grey RAL 7038 embossed		87595	87596
metal grey RAL 9006		87592	87593
ancient grey		87586	87587
white ST NEW		87536	87537
<i>euro/pc</i>			

INSIDE CORNER 90°

pack 5 pcs H

ART.	finishing	H	
		10	12,5
		CPGV/55/10/I	CPGV/55/12/I
COLOUR-COATED ALUMINIUM			
ancient grey		87566	87567
white ST NEW		87538	87539
<i>euro/pc</i>			

JUNCTION

width = 70 mm - pack 5 pcs H

ART.	finishing	H	
		10	12,5
		CPGV/55/10/G	CPGV/55/12/G
COLOUR-COATED ALUMINIUM			
ash grey RAL 7038		87610	87610
ash grey RAL 7038 embossed		87612	87612
metal grey RAL 9006		87594	87594
ancient grey		87611	87611
white ST NEW		87528	87528
<i>euro/pc</i>			

no partial packaging



CPNV/45/ ash grey RAL 7038 embossed colour-coated aluminium

Protec CPNV is a series of edge profiles for the protection and the finishing of the outside edges of terraces and balconies. Available in colour-coated aluminium, they can be installed flush with the border or detached from it. Their special section makes them suitable for the protection of the borders of steps or sidewalks, since it hides the junction between the tread and the riser. Protec CPNV is also available in the bendable version CPNVF, provided with a special cutout that allows to bend the profile with a radius up to 40 cm.

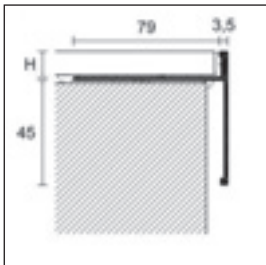

CPNV/45/

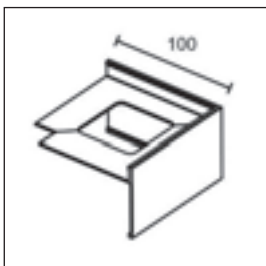

CPNV/45/ /E

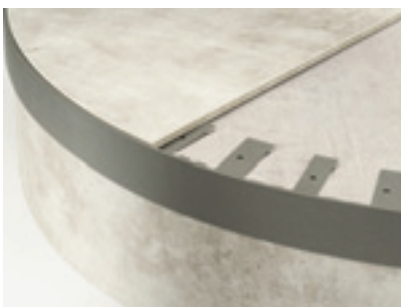

CPNVF/45/10 ancient grey colour-coated aluminium

PROTEC

length = 270 cm - pack 10 pcs		H			
ART.	finishing	10	11	12,5	
COLOUR-COATED ALUMINIUM					
CPNV/45/	ash grey	[Color swatches]	87270	87271	87272
	RAL 7038 embossed		87273	87274	87275
	ancient grey				
euro/m					

white RAL 9003, dark brown RAL 8019, metal grey RAL 9006, aluminium grey RAL 9007, ash grey RAL 7038 and rust with a minimum of 270 meters, on request, without surcharge. For different colours, please contact our Sales Department.

OUTSIDE CORNER 90°

pack 5 pcs		H			
ART.	finishing	10	11	12,5	
COLOUR-COATED ALUMINIUM					
CPNV/45/E	ash grey	[Color swatches]	87276	87277	87278
	RAL 7038 embossed		87279	87280	87281
	ancient grey				
euro/pc					

JUNCTION

width = 70 mm - pack 5 pcs		H			
ART.	finishing	10	11	12,5	
COLOUR-COATED ALUMINIUM					
CPNV/45/G	ash grey	[Color swatches]	87282	87283	87284
	RAL 7038 embossed		87285	87286	87287
	ancient grey				
euro/pc					

no partial packaging

NEW PROTEC FLEX

length = 270 cm - pack 2 pcs		H		
		10		
ART.	finishing	CPNVF/45/		
COLOUR-COATED ALUMINIUM				
	ash grey RAL 7038 embossed	[Color swatches]	87288	
	ancient grey	[Color swatches]	87289	
euro/m				

no partial packaging

For other heights and finishes of Flex profiles, please contact our Sales Department.

For a single piece, see sales conditions on page 305



Protec CPEV and CPEI are a series of edge reversible profiles for the protection and finishing of the outside edges of terraces and balconies. Available in stainless steel and colour-coated aluminium, they can be installed flush with the border or detached from it. They can be used with tiles or marble thicknesses from 11 to 32 mm. The particular section is recommended to protect the stair nosing and sidewalk edge, hiding the connection between tread and riser.

CPEV/45/12 colour-coated aluminium ancient grey

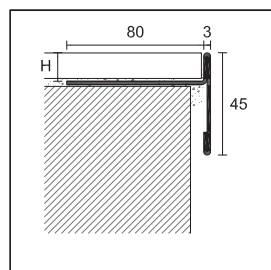

CPEV/45/

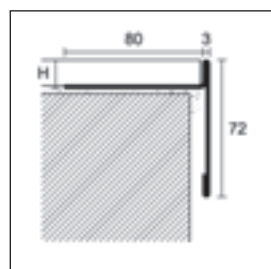

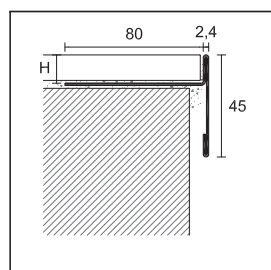

CPEV/72/



CPEI/

PROTEC

length = 270 cm - pack 10 pcs		H				
		11	12,5	15	20	12,5
ART.		CPEV/45/				CPEV/72/
finishing						
COLOUR-COATED ALUMINIUM						
ash grey RAL 7038		87530	87550	87551	87552	87252
metal grey RAL 9006		87531	87540	87541	87542	-
ancient grey		87532	87553	87554	87555	-
euro/m						

for CPEV/72 white RAL 9003, dark brown RAL 8019, metal grey RAL 9006, aluminium grey RAL 9007, ancient grey, ash grey RAL 7038 embossed and rust with minimum 270 meters, on request, without surcharge. For different colours, please contact our Sales Department. For CPEV/45 white RAL 9003, dark brown RAL 8019, aluminium grey RAL 9007, ash grey RAL 7038 embossed and rust with minimum 270 meters, on request, without surcharge. For different colours, please contact our Sales Department.

PROTEC



length = 270 cm - pack 10 pcs		H			
		12,5	15	20	
ART.		CPEI/45/			
STAINLESS STEEL					
polished stainless steel AISI 304 DIN 1.4301		-	87570	87571	87572
euro/m					

Complete the article code with H measure
(for example CPEV/45/ for H=12,5 becomes CPEV/45/12)

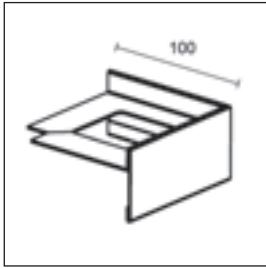

For a single piece, see sales conditions on page 305



OUTSIDE CORNER 90°

pack 5 pcs		H				
		11	12,5	15	20	12,5
ART.	CPEV/45/ /E					CPEV/72/ /E
finishing						
COLOUR-COATED ALUMINIUM						
ash grey RAL 7038		87533	87556	87557	87558	87255
metal grey RAL 9006		87534	87543	87544	87545	-
ancient grey		87535	87559	87560	87561	-
<i>euro/pc</i>						

JUNCTION

width = 70 mm - pack 5 pcs		H				
		11	12,5	15	20	12,5
ART.	CPEV/45/ /G					CPEV/72/ /G
finishing						
COLOUR-COATED ALUMINIUM						
ash grey RAL 7038		87562	87562	87562	87562	87258
metal grey RAL 9006		87546	87546	87546	87546	-
ancient grey		87563	87563	87563	87563	-
<i>euro/pc</i>						

no partial packaging

OUTSIDE CORNER 90°

pack 5 pcs		H			
		12,5	15	20	
ART.	CPEI/45/ /E				
STAINLESS STEEL					
polished stainless steel AISI 304 DIN 1.4301		-	87573	87574	87575
<i>euro/pc</i>					

JUNCTION

width = 70 mm - pack 5 pcs		H			
		12,5	15	20	
ART.	CPEI/45/ /G				
STAINLESS STEEL					
polished stainless steel AISI 304 DIN 1.4301		-	87576	87576	87576
<i>euro/pc</i>					

no partial packaging



CPEV/45/12/E + CPEV/45/12/G Ancient grey colour-coated aluminium

Complete the article code with H measure
(for example CPEV/45/ for H=12,5 becomes CPEV/45/12)

For a single piece, see sales conditions on page 305





stair nosing profiles

Protection, finishing and safety.
Protect and Prostep are two ranges
of stair nosing profiles for stairs for
public and private use.



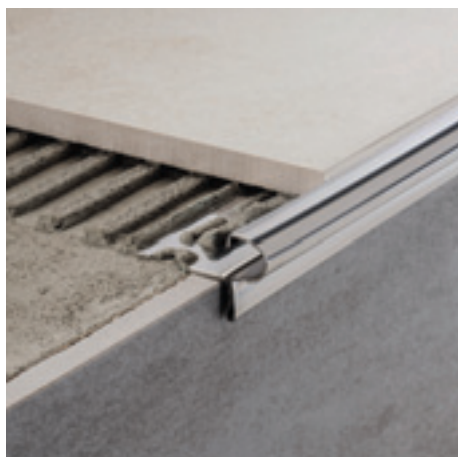

SGI/11 polished stainless steel AISI 304 DIN 1.4301

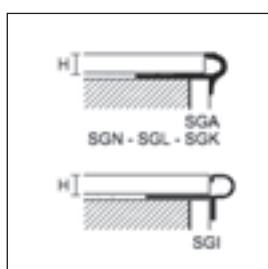

Prostep SGA, SGI, SGN, SGL and SGK are profiles for realisation and protection of ceramic, marble and stone steps. Thanks to the rounded section, they give elegance to the edges of the steps. The models in chromium-plated brass and anodized aluminium are not recommended in case of intense traffic.

PROSTEP

length = 270 cm - pack 10 pcs		H				
ART.	finishing	7	9	11	13	15
ALUMINIUM						
SGA/	silver anodised	94965	94966	94967	94968	-
	<i>euro/m</i>					-
STAINLESS STEEL						
SGI/	polished stainless steel AISI 304 DIN 1.4301	-	94922	94924	-	-
	<i>euro/m</i>	-			-	-
BRASS						
SGN/	natural brass	94970	94971	94972	-	-
	<i>euro/m</i>				-	-
SGL/	polished brass	94975	94976	94977	-	-
	<i>euro/m</i>				-	-
SGK/	chromium-plated brass	94980	94981	94982	-	-
	<i>euro/m</i>				-	-

individually packed - art. SGK/9 and SGK/11 pack 5 pcs



SMA/4,5 natural aluminium

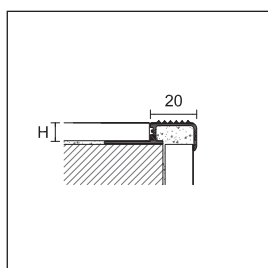

SMA/
SM/

Prostep SMA and SM are aluminium and brass profiles for realization and protection of ceramic, marble and stone steps. Thanks to the grooved top part, they are consistent with DIN 51131 law concerning non-slip stair nosing.

PROSTEP

length= 270 cm - pack 10 pcs		H				
ART.	finishing	4,5	8	10	11	12,5
ALUMINIUM						
	natural aluminium	93967	93969	93970	93979	93971
	<i>euro/m</i>					
SMA/	silver anodised	93975	93976	93977	93980	93978
	<i>euro/m</i>					
BRASS						
SM/	natural brass	-	-	93972	-	93973
	<i>euro/m</i>	-	-		-	

individually packed

Complete the article code with H measure (for example for SGA/ for H=11 becomes SGA/11) - For a single piece, see sales conditions on page 305



IPA/11 silver anodised aluminium

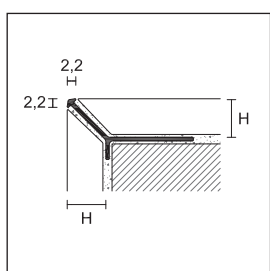

IPA/

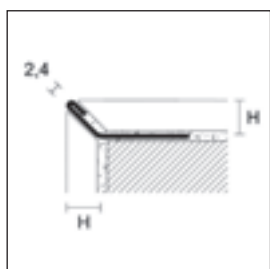

IPI/

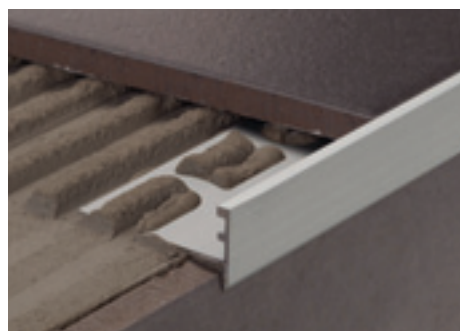

SNG/10 silver anodised aluminium

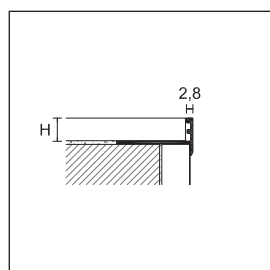

SNG/
SN/

Protrim IPA/ and IPI/ are minimal profiles suitable for the edging of external corners that need the 45 degrees cut. These profiles allow a perfect laying both on coverings and on stairs or platforms in ceramic or wood.

PROTRIM

length = 270 cm - pack 20 pcs H

ART.	finishing	4,5	8	11	15
------	-----------	-----	---	----	----

ALUMINIUM

IPA/	silver anodised		95006	95178	95181	95185
	euro/m					
IPB/	bright polished silver		95008	-	-	-
	euro/m					

individually packed

PROTRIM

length = 270 cm - pack 20 pcs H

ART.	finishing	7	8	11	12,5
------	-----------	---	---	----	------

STAINLESS STEEL

IPI/	stainless steel AISI 304 - DIN 1.4301		95169	95170	95173	95174
	euro/m					

individually packed

Prostep SNG and SN are aluminium and brass profiles for realization and protection of ceramic, marble and stone steps.

PROSTEP

length = 270 cm - pack 20 pcs H

ART.	finishing	8	10	12,5	15
------	-----------	---	----	------	----

ALUMINIUM

	natural aluminium		90040	90042	90044	90046
	euro/m					
SNG/	silver anodised		90041	90043	90045	90047
	euro/m					

SN/	natural brass		93991	93992	93993	-
	euro/m					

individually packed - SN/ pack 10 pcs



SAR/10/12 silver anodised aluminium



SIR/10/12 stainless steel AISI 304 DIN 1.4301

Prostep SAR and SIR are aluminium or stainless steel stair nosing profiles ideal to protect the edge of the stair. They can also be used as protection profiles of the edges of sidewalks. Thanks to the reversible shapes, these two models are ideal to be used for tiles of 4 different thicknesses.

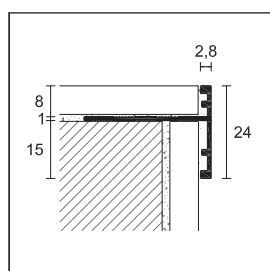

SAR/8

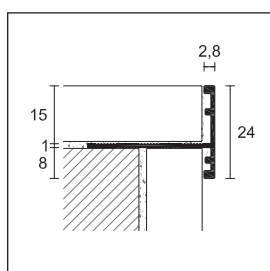

SAR/15

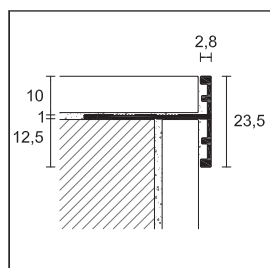

SAR/10

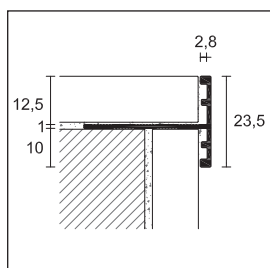

SAR/12

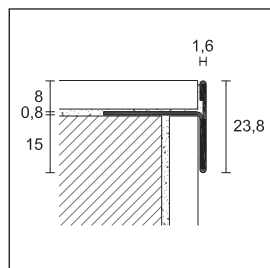

SIR/8

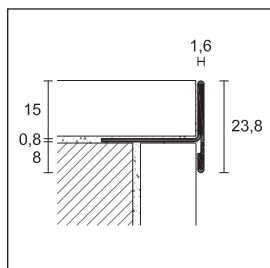

SIR/15

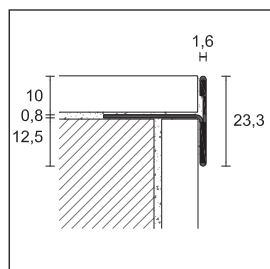

SIR/10

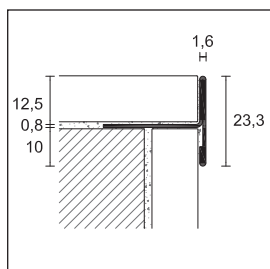

SIR/12

PROSTEP

length = 270 cm - pack 10 pcs

ART. finishing

ALUMINIUM

SAR/8/15	silver anodised		93956
	<i>euro/m</i>		

SAR/10/12	silver anodised		93958
	<i>euro/m</i>		

individually packed

PROSTEP

length = 270 cm - pack 10 pcs

ART. finishing

STAINLESS STEEL

SIR/8/15	polished stainless steel AISI 304 DIN 1.4301		93952
	<i>euro/m</i>		

SIR/10/12	polished stainless steel AISI 304 DIN 1.4301		93954
	<i>euro/m</i>		

individually packed

STAINLESS STEEL

SIRS/8/15	satin stainless steel AISI 304 DIN 1.4301		93953
	<i>euro/m</i>		

SIRS/10/12	satin stainless steel AISI 304 DIN 1.4301		93955
	<i>euro/m</i>		

individually packed

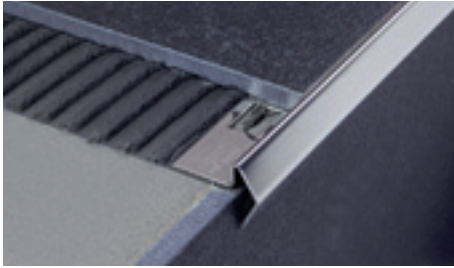

SI/10 polished stainless steel AISI 304 - DIN 1.4301

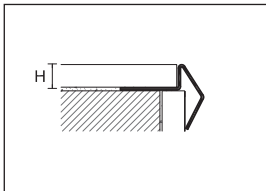

SI/

Prostep SI is a stainless steel profile for realization and protection of ceramic, marble and stone steps. They have an excellent resistance to main chemicals and atmospheric agents and it is particularly suitable for protection of stairs in case of high pedestrian traffic.

PROSTEP

length = 270 cm - pack 10 pcs H

ART.	finishing	8	10	12,5
------	-----------	---	----	------

STAINLESS STEEL

SI/	polished stainless steel AISI 304 DIN 1.4301		93962	93963	93964
<i>euro/m</i>					

individually packed

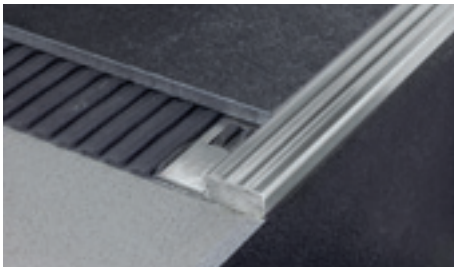

SIS/10 satin stainless steel AISI 304 - DIN 1.4301

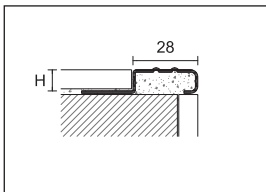

SIS/

Prostep SIS is a stainless steel profile for realization and protection of ceramic, marble and stone steps. They have an excellent resistance to main chemicals and atmospheric agents and they are in accordance with DIN 51131 regulation of non-slip stair nosing thanks to their satin tread. It is particularly suitable for protection of stairs in case of high pedestrian traffic.

PROSTEP

length = 270 cm - pack 10 pcs H

ART.	finishing	10	11	12,5
------	-----------	----	----	------

STAINLESS STEEL

SIS/	satin stainless steel AISI 304 DIN 1.4301		93987	93989	93988
<i>euro/m</i>					

SIS/10/SF	satin stainless steel AISI 304 DIN 1.4301		93997	-	-
<i>euro/m</i>					

individually packed

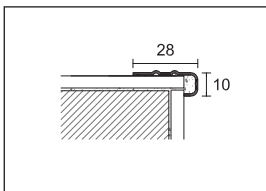

SIS/10/SF

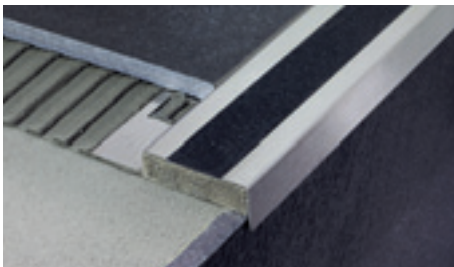

SIX/10 satin stainless steel AISI 304 - DIN 1.4301 + black slip-resistant 25 mm

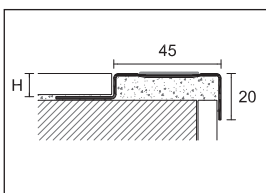

SIX/

Prostep SIX is a stainless steel profile for realization and protection of ceramic, marble and stone steps. They are in accordance with DIN 51131 regulation of non-slip stair nosing thanks to the application of non-slip strips: Safety-Step. It is particularly suitable to protect the stairs in case of high pedestrian traffic.

PROSTEP

length = 270 cm - pack 10 pcs H

ART.	finishing	8	10	12,5
------	-----------	---	----	------

STAINLESS STEEL

SIX/	satin stainless steel AISI 304 DIN 1.4301 + black slip-resistant 25 mm		93981	93982	93983
<i>euro/m</i>					

individually packed

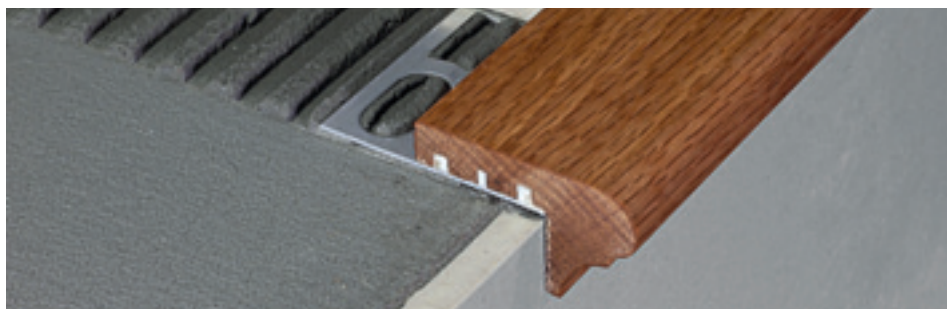



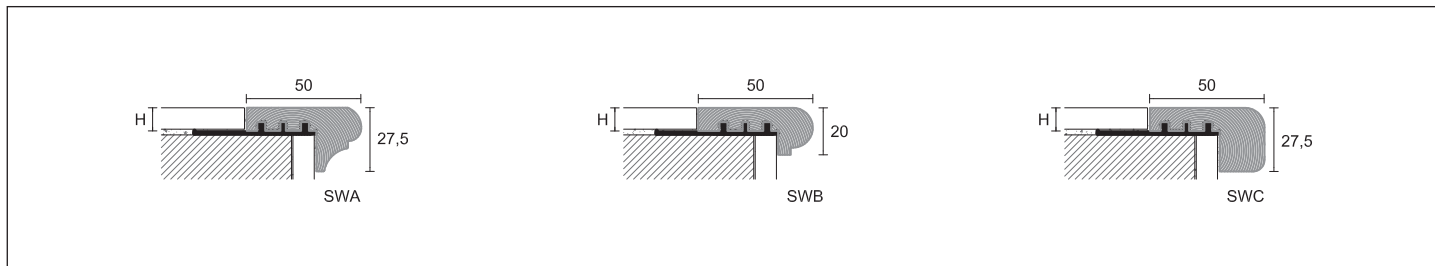

SWA/10 oak

Prostep Wood is a line of profiles made of solid wood and aluminium base for realization and protection of ceramic, wood or brick floors. Available in different heights, we recommend to paint it or immediately after installation for best finishing and durability results. They are particularly suitable for steps borders indoor for a high aesthetic value.



PROSTEP WOOD

length = 270 cm - pack 5 pcs		H			
ART.	finishing	10	12,5	15	22
	oak	 90480	90484	90488	90492 *
SWA/	<i>euro/m</i>				
	mahogany	 90496 *	90500 *	-	-
	<i>euro/m</i>				
SWB/	oak	 90512	90516	-	-
	<i>euro/m</i>				
SWC/	oak	 90530	90534	-	-
	<i>euro/m</i>				

art. SWA, SWB, SWC available in length 90-135 cm with a minimum order of 12 pcs and a surcharge euro/pc

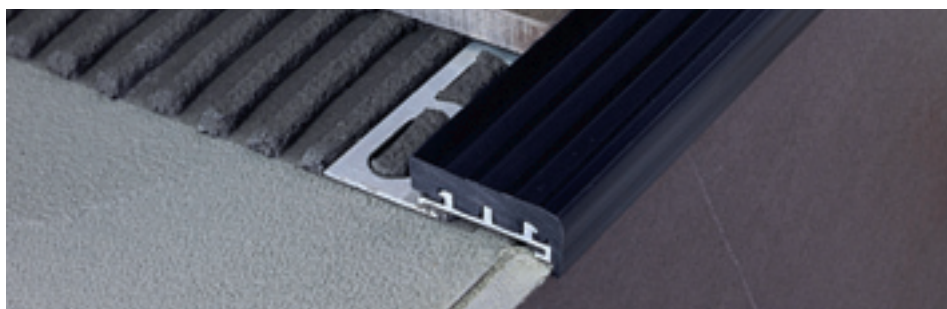

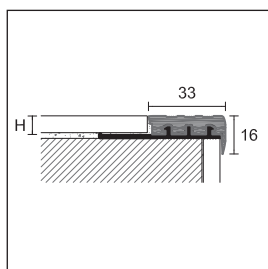

SP/10 + Black PVC

Prostep SP is a line of profiles in PVC with aluminium base for realization and protection of ceramic, stone or brick floors. The grooved PVC insert is in accordance with DIN 51131 regulation of non-slip stair nosing.



SP/

PROSTEP

length = 270 cm - pack 10 pcs		H		
ART.	finishing	8	10	12,5
	aluminium + black PVC	 95200	95210	95220
SP/	aluminium + light grey PVC	 95201	95211	95221
	aluminium + Brown PVC	 95202	95212	95222
	<i>euro/m</i>			

Complete the article code with H measure (for example SWA/ for H=10 becomes SWA/10) - * Out of production items, available till end of stock - For a single piece, see sales conditions on page 305

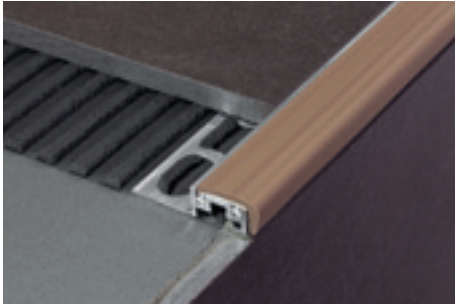

SA/10 aluminium + hazel PVC

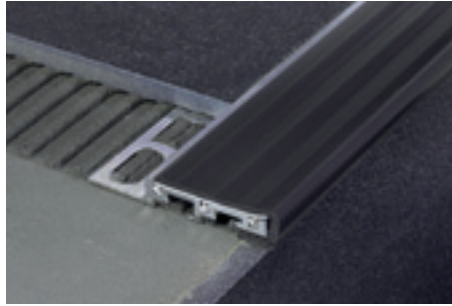

SB/10 aluminium + dark grey PVC

Prostep SA and SB is a line of profiles in PVC with aluminium base for realization and protection of ceramic, stone or brick floors. The grooved PVC insert is in accordance with DIN 51131 regulation of non-slip stair nosing.

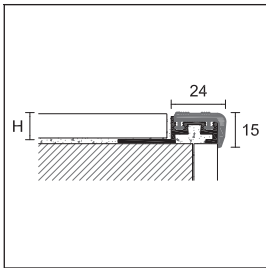

SA/

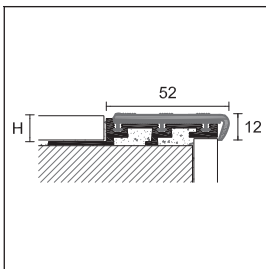

SB/



111/4/F silver anodised aluminium



75/F silver anodised aluminium

Prostep 111 and 75 are anodised aluminium profiles for realization and protection of stairs with floors with small thickness. They are suitable also for LVT floorings.

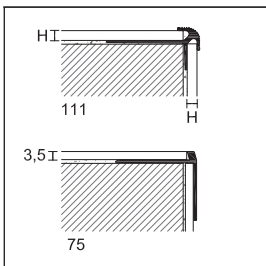

Complete the article code with H measure (for example SA/ for H=8 becomes SA/8)

* Out of production items, available till end of stock

For a single piece, see sales conditions on page 305

PROSTEP

length = 270 cm - pack 10 pcs

		H			
ART.	finishing	8	10	12,5	15
SA/	aluminium + light grey PVC	94001	94061	94121	-
	aluminium + hazel PVC	94021 *	94081	94141	-
	aluminium + dark grey PVC	94041	94101	94161	-
<i>euro/m</i>					

SPARE PVC - pack 10 pcs

SA/G	light grey PVC		94902		
	hazel PVC		94907		
	dark grey PVC		94913		
<i>euro/m</i>					

length = 270 cm - pack 10 pcs

		H			
ART.	finishing	8	10	12,5	15
SB/	aluminium + light grey PVC	94401 *	94461 *	94521 *	94581 *
	aluminium + hazel PVC	94421 *	94481 *	94541 *	94601 *
	aluminium + dark grey PVC	94441	94501	94561	94621
<i>euro/m</i>					

SPARE PVC - pack 10 pcs

SB/G	light grey PVC		94952		
	hazel PVC		94958		
	dark grey PVC		94963		
<i>euro/m</i>					

no partial packaging with SA/G and SB/G

PROTECT

length = 270 cm - pack 20 pcs

		H			
ART.	finishing	2,5	4,5	5	6
ALUMINIUM					
111/ /F	silver anodised	75782	75784	75785	75786
<i>euro/m</i>					

PROTECT

length = 340 cm - pack 20 pcs

		H
ART.	finishing	3,5
ALUMINIUM		
75/F	silver anodised	75388
<i>euro/m</i>		



74/SF silver anodised aluminium

Protect 53, 73, 74 and 58 are profiles for protection of step edge in wood, ceramic or marble already laid. Protec 87, 370 and 373 are in accordance with DIN 51131 regulation of non-slip stair nosing. They are available in version with the holes and self-adhesive.

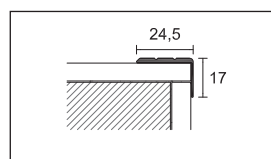

53/

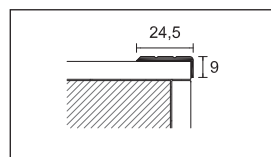

73/

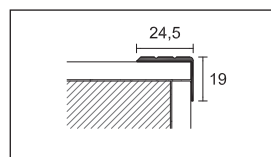

74/

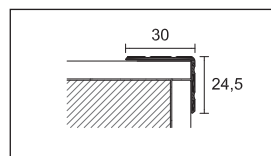

58/

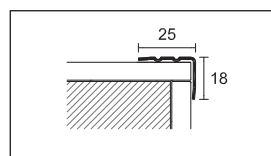

74/IF

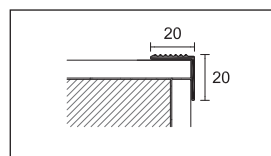

87/
370/

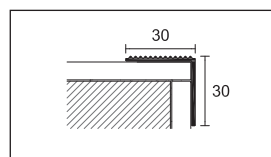

373/

Complete the article code with F=drilled, A/AD=adhesive, SF=undrilled, CV=screws (eg. 73/ drilled becomes 73/F)

packaging in blister no partial packaging

* Out of production items, available till end of stock

For a single piece, see sales conditions on page 305

PROTECT

pack	30 pcs					10 pcs / blister			
length cm	270					90	100	-	
ART.	53/		73/		473/				
finishing	F	SF	F	SF	A	CV	AD	CV	
ALUMINIUM									
silver anodised		75200 75203	75208 75209	75238	21422 21434	00337	-		
gold anodised		75201 75204	75218 75219 *	75248	21423 21435	00338	-		
bronze anodised		- -	75228 *	- 75258	21424 *	- -	-		
euro/m									
euro/pc									
pack	20 pcs.		30 pcs		10 pcs / blister			20 pcs	
ART.	58/		74/		474/			74/I	
finishing	A	-	F	SF	A	CV	AD	CV	
ALUMINIUM									
silver anodised		75900 -	75268 75269	75298	21512 21524	00390	-		
gold anodised		75910 *	75278 -	75308	21513 21525	00392	-		
bronze anodised		- -	75288 *	- 75318	21514 * 21526 *	- -	-		
euro/m									
euro/pc									
titanium anodised		- -	- -	75299	- -	- -	-		
euro/m									
colour-coated anthracite grey RAL 7016		- -	- -	75300 *	- -	- -	-		
euro/m									
length cm									270
STAINLESS STEEL									
satin stainless steel AISI 304 DIN 1.4301		- -	- -	-	- -	- -	- -	75275	
euro/m									

art. 53/, 73/, 58/ and 74/ individually packed

PROTECT

pack	30 pcs			10 pcs / blister	
length cm	340			113	
ART.	87/			487/	
finishing	F	SF	A	CV	AD
ALUMINIUM					
silver anodised		75108	75109	75138	22615 22641
euro/m					- -
euro/pc					
pack	10 pcs			5 pcs	
length cm	270			270	
ART.	370/			373/	
finishing	F	SF	A	F	A
BRASS					
polished		75168 *	75169	75178	75188 75198
euro/m					

art. 87/ and 370/ individually packed



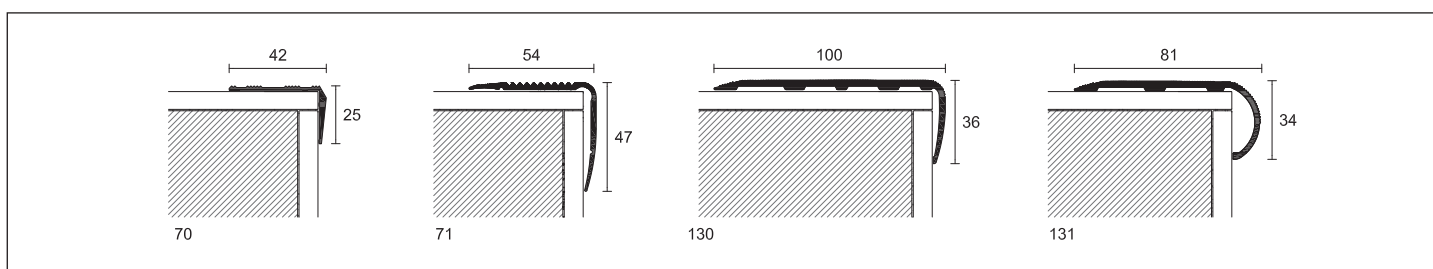

71/SF silver anodised aluminium

Protect 70, 71, 130 and 131 are profiles for protection of step edge in wood, ceramic or marble already laid. They are in accordance with DIN51131 regulation concerning non-slip stair nosing. They are available in the version with holes and self-adhesive and they are particularly suitable for public environments in adaptation to standards.



PROTECT

pack	20	10 pcs / blister 			
length cm	340	113	166		
ART.	70/	470/			
finishing	F	SF	A	CV	CV
ALUMINIUM					
silver anodised	 75328	75329	75358	21560	21564
gold anodised	 75338	-	75368	21561	21565
euro/m				-	-
euro/pc	-	-	-		

art. 70/ individually packed

PROTECT

pack	20 pcs	8 pcs	8 pcs			
length cm	340	270	270			
ART.	71/	130/	131/			
finishing	F	SF	F	SF	F	SF
ALUMINIUM						
silver anodised	 64067	64066	75804	75805	75800 *	75801 *
euro/m						

Complete the article code with F=drilled, A/AD=adhesive, SF=undrilled, CV=with screws (eg. 87/ drilled becomes 87/F)

 packaging in blister no partial packaging

For a single piece, see sales conditions on page 305

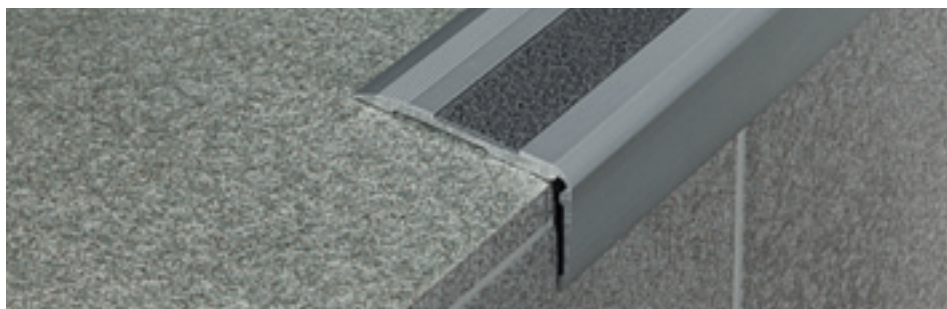



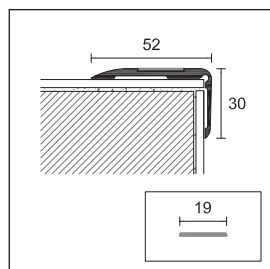

76/F silver anodised aluminium + black slip-resistant insert

Protect 76, 124, 110, 119, 117 and 80 are anodised aluminium profiles with insert non-slip roll Safety-Step replaceable for the protection fo step edge in ceramic, wood, marble and carpet already laid. They are in accordance with DIN 51131 regulation of non-slip stair nosing.They are available in the version with holes and self-adhesive and they are particularly suitable for public environments in adaptation to standards.



76/

PROTECT

pack	24 pcs	5 pcs / blister 	
length cm	340	113	
ART.	76/	476/	
finishing	F	CV	AD
ALUMINIUM			
silver anodised	 75448	21680	21696
gold anodised	 75458	21681	21697
bronze anodised	 75468 *	-	-
euro/m		-	-
euro/pc	-		
SLIP-RESISTANT ROLL			
length = 1820 cm - width mm		19	
4 rolls pack -			
black		23002	
euro/m			

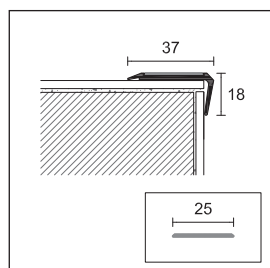

124/

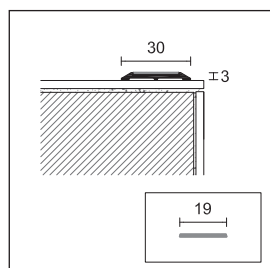

PROTECT

length = 270 cm - pack 24 pcs			
ART.		124/	
finishing		F	
ALUMINIUM			
silver anodised		75794	
euro/m			
SLIP-RESISTANT ROLL			
length = 1820 cm - width mm		25	
4 rolls pack -			
black		23004	
euro/m			



110/

PROTECT

length = 270 cm - pack 24 pcs			
ART.		110/	
finishing		F	
ALUMINIUM			
silver anodised		75780	
euro/m			
SLIP-RESISTANT ROLL			
length = 1820 cm - width mm		19	
4 rolls pack -			
black		23002	
euro/m			

The price per meter of 76/, 124/ and 110/ does not include the non-slip insert that must be ordered separately.

Complete the article code with F=drilled, AD=adhesive, CV=screws (eg. 110/ drilled becomes 110/F)

 packaging in blister no partial packaging

* Out of production items, available till end of stock

For a single piece, see sales conditions on page 305



124/F silver anodised aluminium + black slip-resistant insert

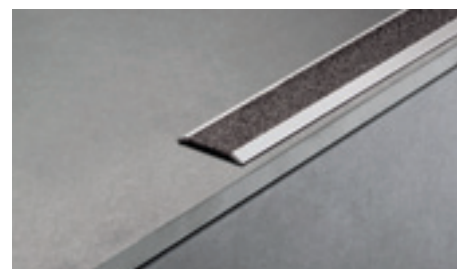

110/F silver anodised aluminium + black slip-resistant insert

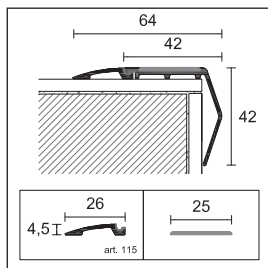

119/
115

PROTECT

pack	12 pcs	24 pcs
length cm	270	270
ART.	119/	115
finishing	F	-
ALUMINIUM		
silver anodised	 75792 *	75788 *
<i>euro/m</i>		

SLIP-RESISTANT ROLL

length = 1820 cm - width mm	25
4 rolls pack -	
black	 23004
<i>euro/m</i>	

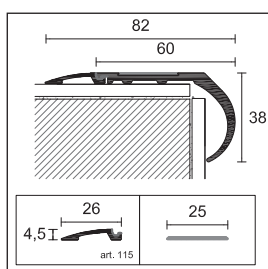

117/
115

PROTECT

pack	12 pcs	24 pcs
length cm	270	270
ART.	117/	115
finishing	F	-
ALUMINIUM		
silver anodised	 75790 *	75788 *
<i>euro/m</i>		

SLIP-RESISTANT ROLL

length = 1820 cm - width mm	25
4 rolls pack -	
black	 23004
<i>euro/m</i>	

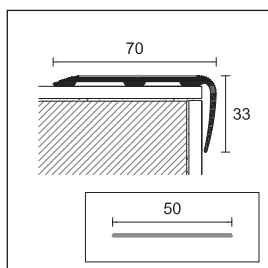

80/

PROTECT

length = 340 cm - pack 10 pcs	
ART.	80/
finishing	F
ALUMINIUM	
silver anodised	 64077
<i>euro/m</i>	

SLIP-RESISTANT ROLL

length = 1820 cm - width mm	50
2 rolls pack -	
black	 23006
<i>euro/m</i>	

The price per meter of 119/, 115/, 117/ and 80/ does not include the non-slip insert that must be ordered separately.

Complete the article code with F=drilled (eg. 119/ drilled becomes 119/F)

• Out of production items, available till end of stock

For a single piece, see sales conditions on page 305

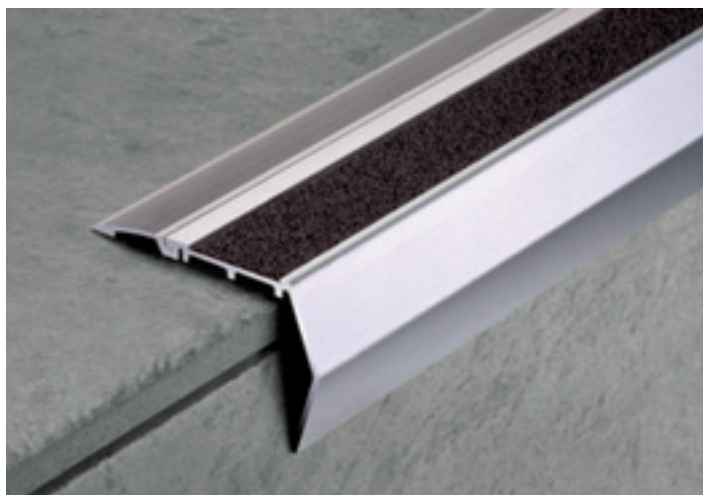

119/F + 115/ silver anodised aluminium

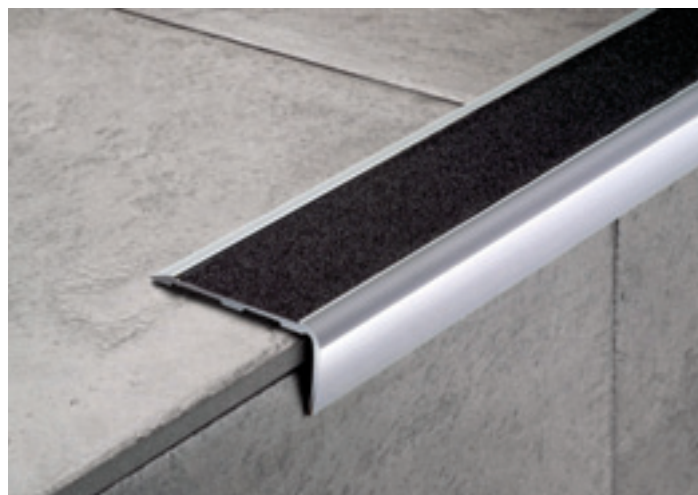

80/F silver anodised aluminium



72/F silver anodised aluminium + GM/72 black

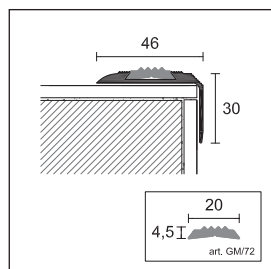

Protect 72/, 77/, 79/, 125/, 78/, 126/ and 128/ are anodised aluminium profiles with rubber insert replaceable for the protection fo step edge in ceramic, wood, marble and carpet already laid. They are in accordance with DIN 51131 regulation of non-slip stair nosing. They are available in the version with holes and self-adhesive and they are particularly suitable for public environments in adaptation to standards.



72/

PROTECT

length = 340 cm - pack 20 pcs

ART.		72/
finishing		F
ALUMINIUM		
silver anodised		75508
gold anodised		75518
bronze anodised		75528 *

euro/m

GROOVED RUBBER



length = 3400 cm - 2 rolls pack

ART.		GM/72
black		75565
brown		75569 *

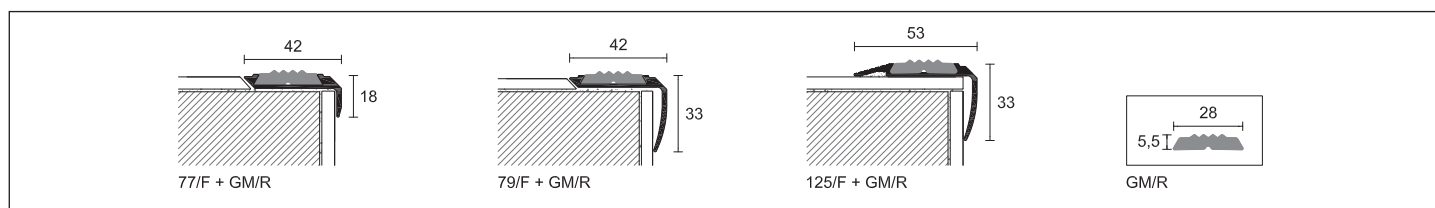
euro/m



PROTECT

pack	20	24		
length cm	340	270		
ART.	77/	79/	125/	
finishing	F	F	F	
ALUMINIUM				
silver anodised		75648	75728	75796
bronze anodised		75668 *	-	-

euro/m

GROOVED RUBBER

length = 3400 cm - 2 rolls pack

ART.		GM/R
black		75705

euro/m

The price per meter of 72/, 77/, 79/ and 125/ does not include the grooved rubber that must be ordered separately.

Complete the article code with F=drilled (eg. 72/ drilled becomes 72/F)

* Out of production items, available till end of stock

For a single piece, see sales conditions on page 305



77/F silver anodised aluminium + GM/R black

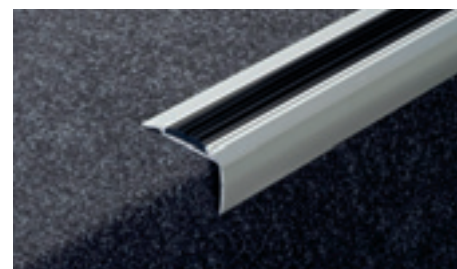

125/F silver anodised aluminium + GM/R black

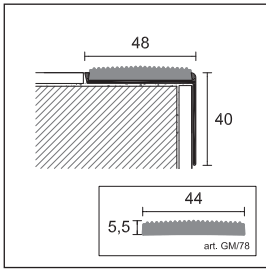

78/

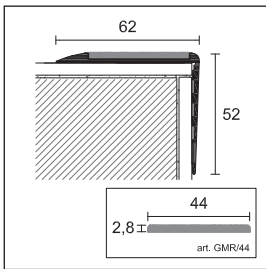

126/

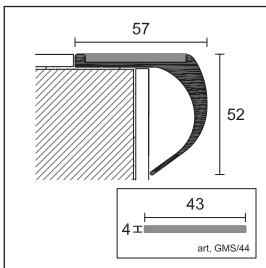

128/

PROTECT

length = 340 cm - pack 20 pcs

ART.		78/
finishing		F
ALUMINIUM		
silver anodised		75578
<i>euro/m</i>		

GROOVED RUBBER

length = 1700 cm - 2 rolls pack

ART.		GM/78
black		75635
brown		75639 *
<i>euro/m</i>		

PROTECT

length = 270 cm - pack 6 pcs

ART.	126/	128/
finishing	F	F
ALUMINIUM		
silver anodised		75798
		75802
<i>euro/m</i>		

GROOVED RUBBER

length = 1700 cm - pack 1 roll

ART.	GMR/44	GMS/44 polished
black		75706
		75720
<i>euro/m</i>		

The price per meter of 78/, 126/ and 128/ does not include the grooved rubber that must be ordered separately.

Complete the article code with F=drilled (eg. 78/ drilled becomes 78/F)

* Out of production items, available till end of stock

For a single piece, see sales conditions on page 305



126/F silver anodised aluminium

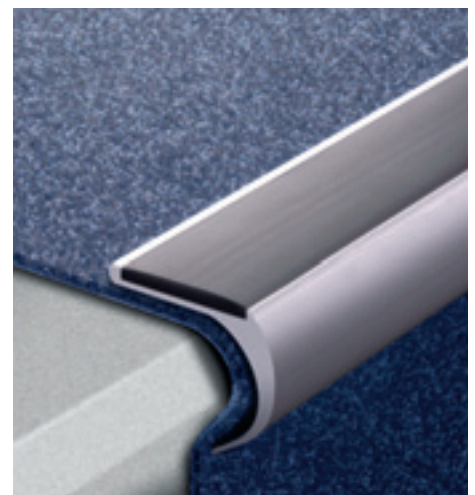

128/F silver anodised aluminium

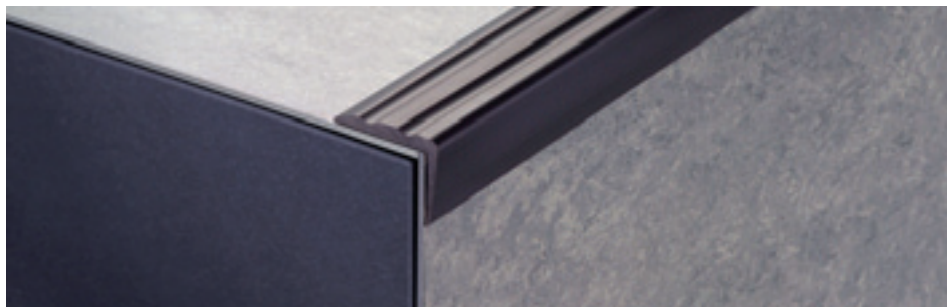

150 black PVC

Protect 150, 151, 152, 153, 154, 155, 156 and 158 are PVC profiles for the protection of the step edge in ceramic, marble, wood, PVC, linoleum, carpet or LVT to be laid or already laid.

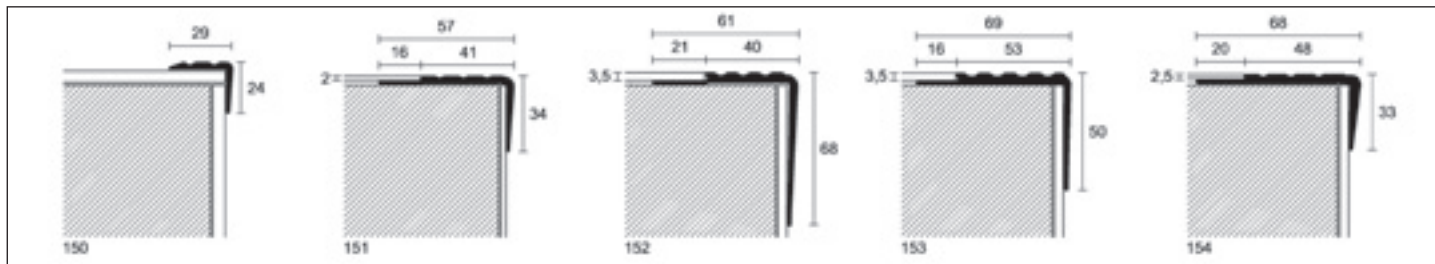

PROTECT

length = 300 cm - pack 15 pcs

ART.	150	151	152	153	154
finishing					
PVC					
black	19100	19110	19120	19130 *	19140
grey	19101	19111	19121	-	19141
brown	19102	19112	-	19132 *	-
euro/m					

no partial packaging

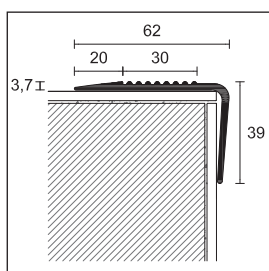

155

PROTECT

length = 300 cm - pack 15 pcs

ART.	155
finishing	
PVC	
black	19150
grey	19151
brown	19152
euro/m	

no partial packaging

* Out of production items, available till end of stock

All articles Protect in PVC should be stored horizontally

For a single piece, see sales conditions on page 305



153 Black PVC

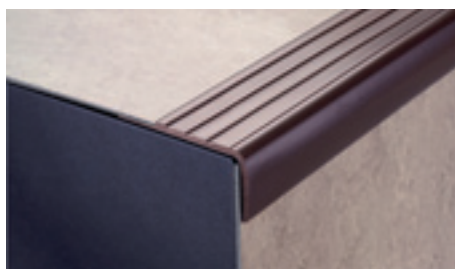

154 Brown PVC

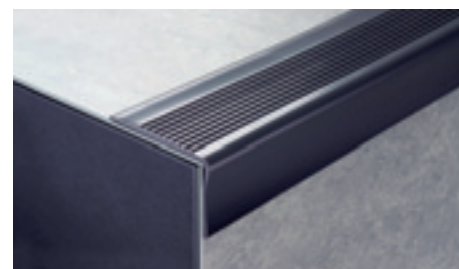

155 Black PVC

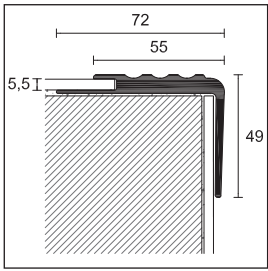

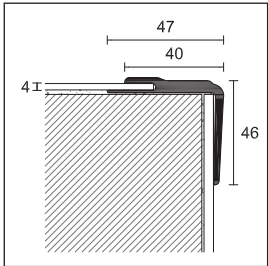

156



158

PROTECT

pack	10	10
length cm	300	300
ART.	156	158
finishing		
PVC		
black	 19160	19180 *
grey	 19161	-
brown	 19162	19182 *
euro/m		

no partial packaging

* Out of production items, available till end of stock

All articles Protect in PVC should be stored horizontally

For a single piece, see sales conditions on page 305

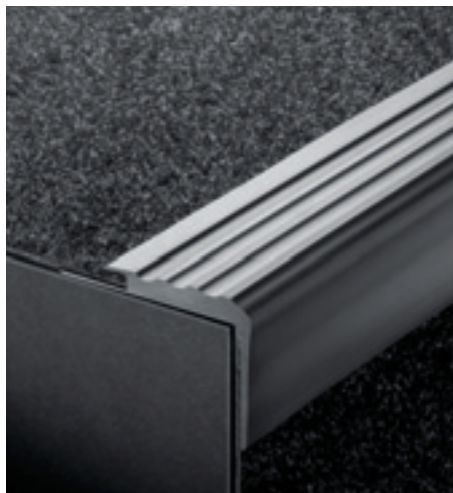

156 Grey PVC

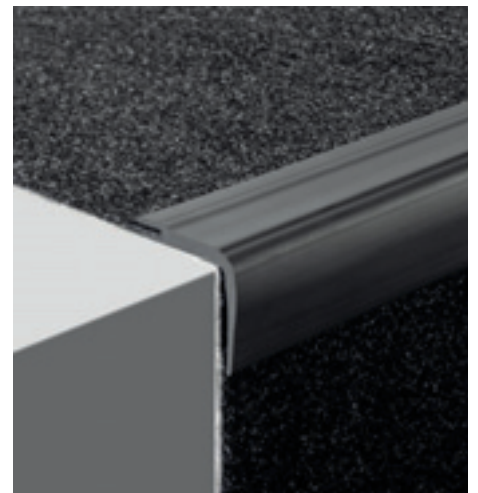

158 Black PVC

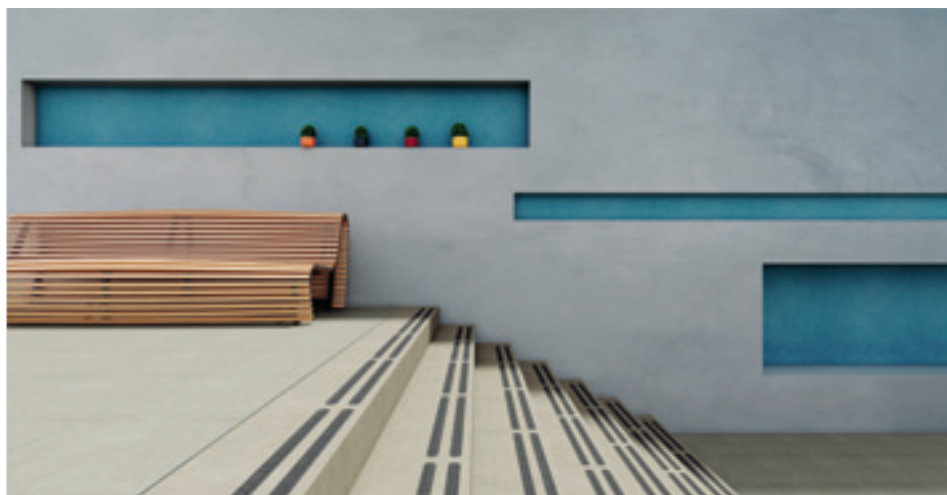

Safety-Step - slip-resistant strip

Slip -resistant strips Safety-Step: it is a line of anti-slip adhesive coverings consisting of abrasive particles aggregated by synthetic resins on dimensionally stable support. Suitable for all surfaces subjected to heavy traffic, both pedestrian and vehicular, such as stairs, hall of office and apartment buildings, ramps, walkways, elevators, platforms machinery, emergency exits etc..

SAFETY-STEP - SLIP-RESISTANT STRIP

colour	width (mm)	length (cm)	code	euro/pc	pack
black	19	61	23000		50
black	25	61	23001		50
black	19	61	23100		10 pcs/blister
black	25	61	23101		10 pcs/blister
transparent	19	61	23016		50

no partial packaging - one blister contains 4 strips

ADHESIVE FOR BORDERS

ml 140 - pack 24 pcs

output: 1 cartridge every 35 meters

ART.

H3502

23181

euro/pc

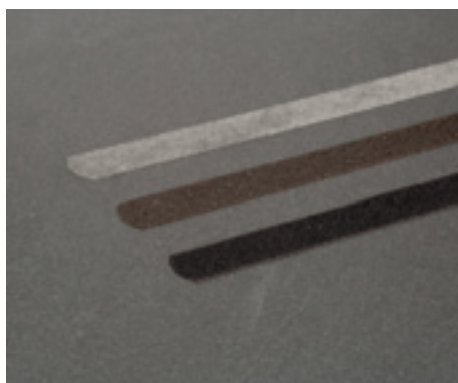

Safety-Step- slip-resistant strip



slip-resistant strip Safety-Step blister packaging



Safety-Step - slip-resistant roll

packaging in blister no partial packaging



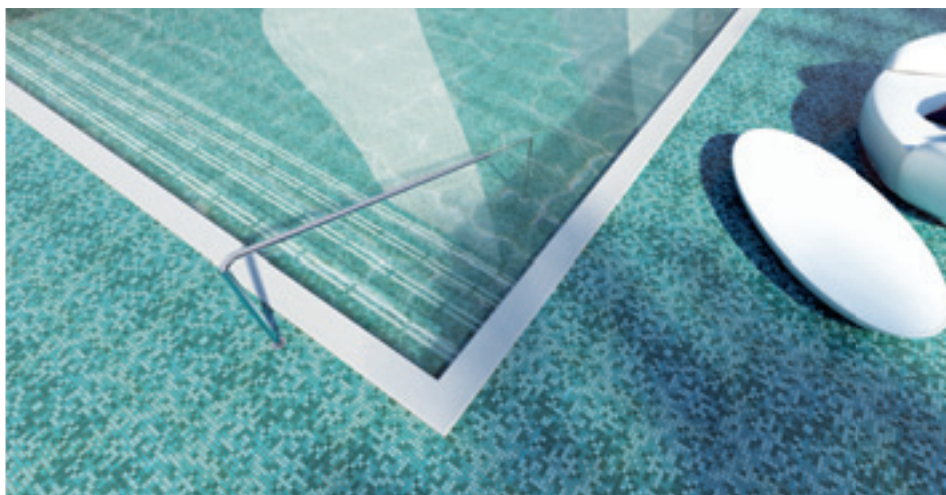









For a single piece, see sales conditions on page 305



Safety-Step - slip-resistant roll

Slip -resistant rolls Safety-Step: it is a line of anti-slip adhesive coverings consisting of abrasive particles aggregated by synthetic resins on dimensionally stable support . Suitable for all surfaces subjected to heavy traffic, both pedestrian and vehicular, such as stairs, hall of office and apartment buildings, ramps, walkways, elevators, platforms machinery, emergency exits etc.. The white and gray versions (Resilient Medium / Fine) consist of a rubber surface, and are perfect for areas of the walkway also barefoot such as showers, locker rooms, saunas, boats, sports equipment and etc...

SAFETY-STEP - SLIP-RESISTANT ROLL

colour		width (mm)	length (cm)	code	euro/pc	pack
black		19	1820	23002		4
black		25	1820	23004		4
black		50	1820	23006		2
black		19	360	23103		10 pcs/ blister
black		25	360	23105		10 pcs/ blister
transparent		19	1820	23018		4
transparent		25	1820	23020		4
transparent		50	1820	23022		2
brown		25	1820	23064 *		4
brown		50	1820	23066 *		2
yellow		25	1820	23028 *		4
yellow		50	1820	23030 *		2
white		25	1820	23036 *		4
white		50	1820	23038 *		2
grey		25	1820	23044		4
grey		50	1820	23046		2

 packaging in blister no partial packaging

* Out of production items, available till end of stock

For a single piece, see sales conditions on page 305



slip-resistant strip Safety-Step

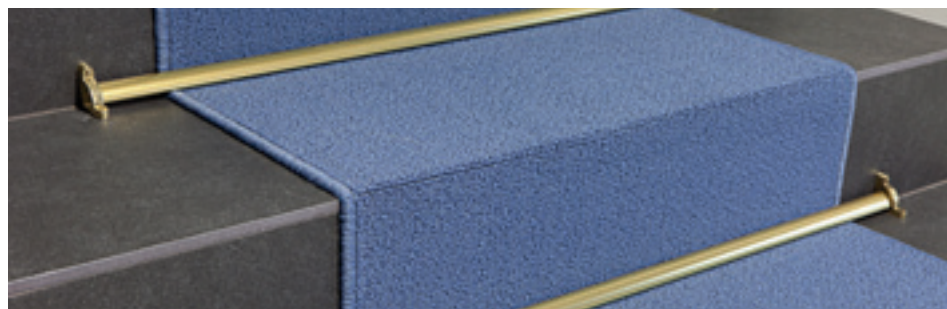

155/16 bright polished gold aluminium + 177/16

Prostair is a system composed of a profile and its relative accessories for the anchorage of stair rods on steps. The fixing accessories permit a quick removal of the stair rods for cleaning or replacement.

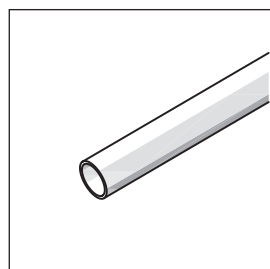

151/11

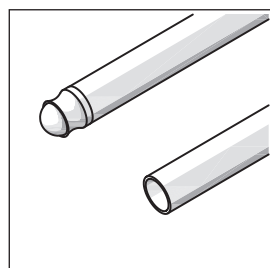

150/

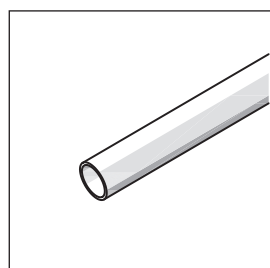

163/

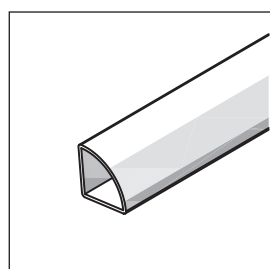

155/16
166/16

items 163/ and 166/ available in requested length. Surcharge euro

Complete the article code with the diameter measure (eg. 150/ with diameter=11 becomes 150/11)

For a single piece, see sales conditions on page 305

PROSTAIR

length = 380 cm - diameter 11 - pack 20 pcs

ART. finishing

ALUMINIUM

151/11	bright polished silver		78430
	<i>euro/m</i>		

PROSTAIR

pack 20 pcs

length cm	80	90	100	120	380
-----------	-----------	-----------	------------	------------	------------

ART. finishing

ALUMINIUM

		diameter				
	11	78311	78312	78313	78314	78319
	<i>euro/pc</i>					-
	<i>euro/m</i>	-	-	-	-	
150/	bright polished gold		78321	-	78323	-
	<i>euro/pc</i>					-
	<i>euro/m</i>	-	-	-	-	
	16	-	-	-	-	78339
	<i>euro/m</i>	-	-	-	-	

pack 10 pcs / blister 

4150/11/S	bright polished gold		21810	21811	21812	-	-
	<i>euro/blister</i>					-	-

articles 150/11, 150/13 and 150/16 of 380 cm partial packaging available and without knobs, for other articles no partial packaging - article 150/13 of 380 cm pack 40 pcs - article 150/16 of 380 cm pack 25 pcs

PROSTAIR

		10 pcs		
pack		10 pcs	10 pcs	10 pcs
length = 380 cm				
finishing				
BRASS		diameter		
		11	13	16
163/	polished		78801	78802
	<i>euro/m</i>			78803

OTHER PROFILES

length = 300 cm - pack 20 pcs

ART. finishing

16x16

ALUMINIUM

155/16	bright polished gold		78379
	<i>euro/m</i>		

length = 320 cm - pack 10 pcs

BRASS

166/16	polished		78820
	<i>euro/m</i>		



163/13 polished brass + 170/13



155/16 bright polished gold aluminium + 168/16 + 178/16

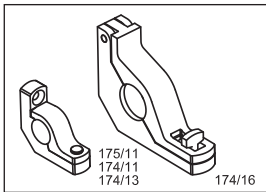

175/11 + 174/

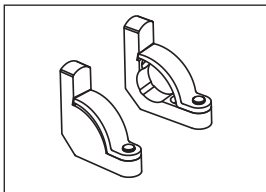

177/16

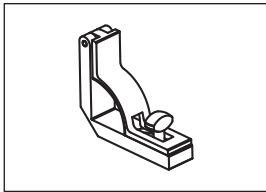

178/16

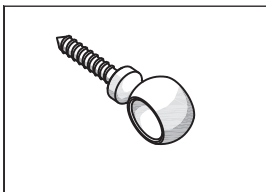

171/ + 170/

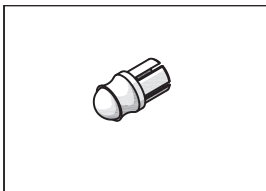

161/11 + 169/

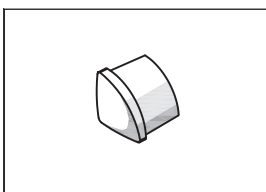

168/16

Complete the article code with diameter measure (eg. 174/ with diameter=11 becomes 174/11)

* Out of production items, available till end of stock

For a single piece, see sales conditions on page 305

ACCESSORIES - BRACKETS

pack 20 pcs		diameter		
ART.	finishing	11	13	16
BRASS				
175/11	chromium plated	78445	-	-
	<i>euro/pc</i>			
pack 20 pcs				
174/	polished	78410	-	78412
	<i>euro/pc</i>			
pack 10 couples 2 pcs dx/sx				
177/16	polished	-	-	78415
	<i>euro/couple</i>			
pack 20 pcs		measures		
		16x16		
178/16	polished		78420	
	<i>euro/pc</i>			

ACCESSORIES - RINGS

pack 20 pcs		diameter		
ART.	finishing	11	13	16
BRASS				
171/11	chromium plated	78440	-	-
	<i>euro/pc</i>			
pack 20 pcs				
170/	polished	78400	78401	78402
	<i>euro/pc</i>			
10 blister packs/ 4 pcs/blister				
4170/ JS	polished	21852	21854 *	-
	<i>euro/blister</i>			

no partial packaging

ACCESSORIES - KNOBS

pack 20 pcs		diameter		
ART.	finishing	11	13	16
BRASS				
161/11	chromium plated	78435	-	-
	<i>euro/pc</i>			
pack 20 pcs				
169/	brass (for aluminium and brass profiles)	78395	78396	78397
	<i>euro/pc</i>			
pack 20 pcs		16x16		
168/16	polished		78418	
	<i>euro/pc</i>			

no partial packaging





profiles for wooden, laminated and LVT floors

A full range of profiles for wooden, laminated and LVT floors. A series of systems and professional solutions proposed in different colours of anodised aluminium and in the exclusive finishes Alcom® Plus, with the possibility of further customization thanks to PDS technology.



unisystem plus



Unisystem Plus is a system for the floating installation of wooden and laminate floors from 6,5 to 22,6 mm thickness. Composed of connection profiles for same and different level floors, perimetral profiles and stair nosing profiles, Unisystem Plus is easy to lay and simple to remove. The system is composed of a top profile, an aluminium base and a fixing clip: after inserting the fixing clip in the top profile, just push the top profile to fix it to the aluminium base.

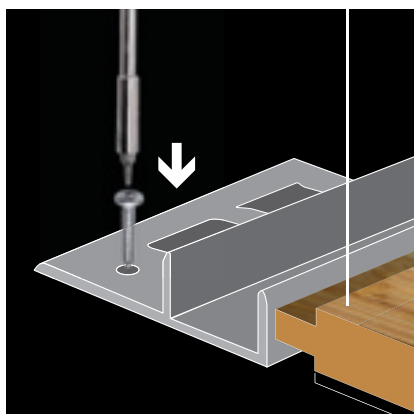

fix the aluminium base to the subfloor with screws or glue

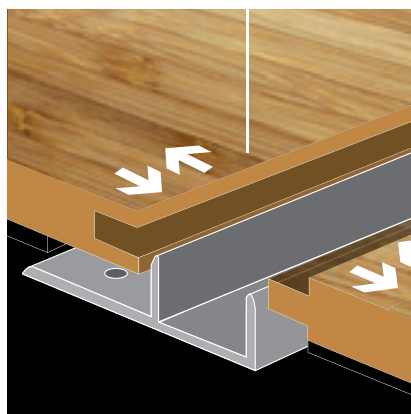

bring the floor planks closer

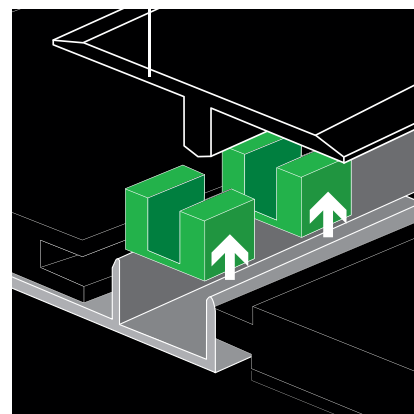

insert the clips in the top profile

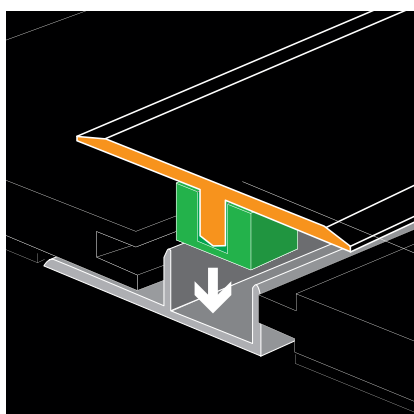

put the top profile in the base

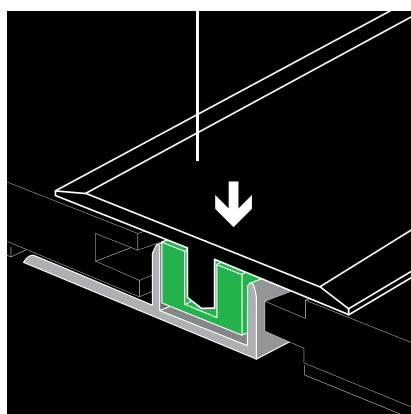

push the top profile in the base

Unisystem Plus line



Connection profiles for floors of same level



Connection profiles for floors of different level



Perimetral profiles

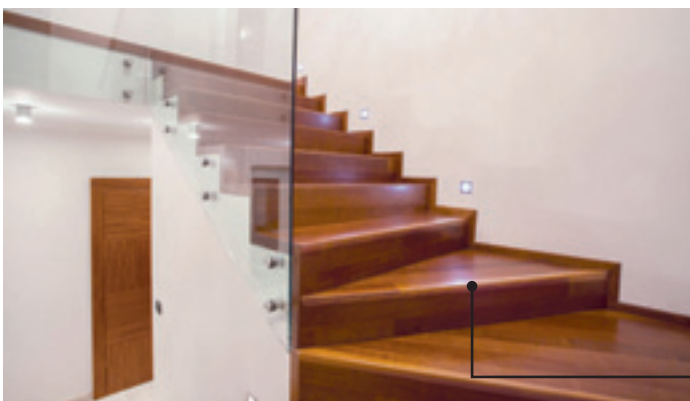

Stair nosing profiles



unisystem - unisystem plus



Z/1/SF aluminium covered with Alclom® Plus film

Z/ are connection profiles for floors of same height. They allow the expansion of wooden or laminate floating floors with thicknesses from 6,5 to 22,6 mm. There is the possibility to choose the base, Unisystem and Unisystem Plus, according to the thickness of the floor.

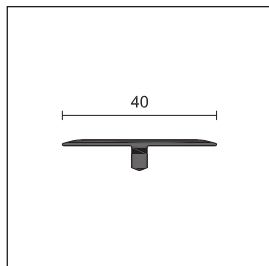

Z/1/SF

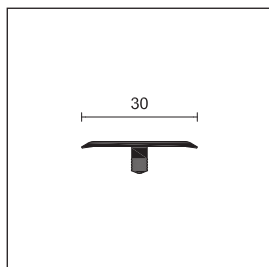

Z3/30/SF

UNISYSTEM/ UNISYSTEM PLUS

length = 270 cm - pack 10 pcs - for floor thicknesses from 6,5 to 22,6 mm

ART. finishing

ALUMINIUM - decorsALCROM® PLUS

	02	66301		47	66344		670	66402 NEW
	04	66302		48	66345		716	66403 NEW
	05	66306		50	66347		848	66404 NEW
	07	66303		60	66357		866	66405 NEW
	08	66304		65	66365		884	66406 NEW
	09	66305		70	66367		912	66407 NEW
	10	66307		71	66368		951	66408 NEW
	11	66308		72	66369		975	66409 NEW
	12	66309		73	66370		1024	66410 NEW
	13	66310		74	66371		1033	66411 NEW
	14	66311		75	66375		1042	66412 NEW
	15	66315		76	66374		1078	66413 NEW
	18	66316		77	66372		1090	66414 NEW
	19	66318		78	66376		1201	66415 NEW
	20	66317		79	66373		1202	66416 NEW
	25	66320		80	66377		1203	66417 NEW
Z/1/SF	26	66321		81	66378		1204	66418 NEW
	30	66327		89	66386		1205	66419 NEW
	31	66328		90	66387		1206	66420 NEW
	32	66329		91	66388		1207	66421 NEW
	34	66331		92	66389		1208	66422 NEW
	35	66332		93	66390		1209	66423 NEW
	36	66333		94	66391		1210	66424 NEW
	37	66334		95	66392		1211	66425 NEW
	38	66335		351	66393 NEW		1212	66426 NEW
	39	66336		363	66394 NEW		1213	66427 NEW
	40	66337		372	66395 NEW		1214	66428 NEW
	41	66338		374	66396 NEW		1215	66429 NEW
	42	66339		490	66397 NEW		1216	66430 NEW
	43	66340		560	66398 NEW		1217	66431 NEW
	44	66341		580	66399 NEW			
	45	66343		590	66400 NEW		100	66432 NEW
	46	66342		665	66401 NEW			

euro/m

individually packed

UNISYSTEM/ UNISYSTEM PLUS

length = 270 cm - pack 20 pcs - for floor thicknesses from 6,5 to 22,6 mm

ART.	finishing	Z/1/SF	Z3/30/SF
ANODISED ALUMINIUM			
silver		67217	63700
gold		67227	63702
gold sand		67234	63704
bronze		67237	-
titanium		67238	-

euro/m

individually packed

For a single piece, see sales conditions on page 305

Profiles of 270 cm length: please order the base separately.

Customized PDS decors on request, see page 220

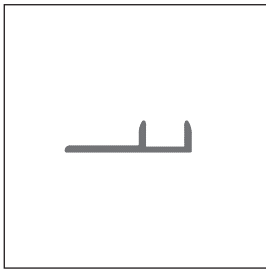

TPU/

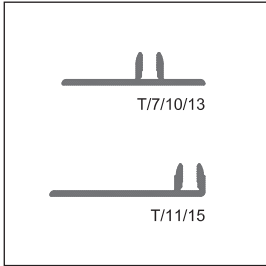

T/

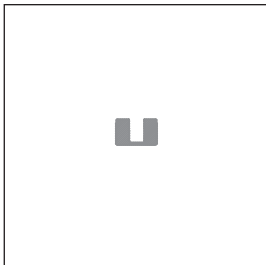

TU/6

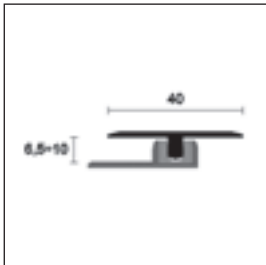

TPZ/47/CV

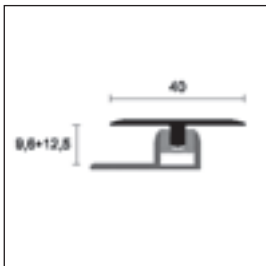

TPZ/410/CV

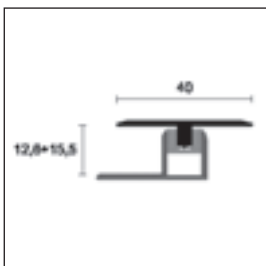

TPZ/413/CV

UNISYSTEM PLUS - BASES

floor thickness from / to mm	6,5/10	9,6/12,5	12,6/15,5	15/19	19,6/22,6	
length = 270 cm pack 20 pcs (15 clips TU/6 included)	H					
ART. finishing	6	10	13	15	22	
ALUMINIUM						
TPU/ natural aluminium		67437	67447	67457	67460	67467
<i>euro/m</i>						

individually packed (art. TPU/22 pack 10 pcs)

UNISYSTEM - BASES

floor thickness from / to mm	6,5/10	10,12	6,5/10	13/15	11/15	
length = 270 cm - pack 20 pcs	H					
ART. finishing	7	10	11	13	15	
ALUMINIUM						
T/ natural aluminium		67287	67297	67317	67307	67327
<i>euro/m</i>						

SPARE CLIPS

pack of 150 pcs	H
	6
TU/6	68812/150
<i>euro/pack</i>	

no partial packaging

UNISYSTEM PLUS

length = 90 cm - pack 10 pcs / blister - for floor thicknesses from 6,5 to 10 mm

ART. finishing								
ALUMINIUM - decors ALCROM® PLUS								
	05	43005 NEW		48	43044		1203	43017 NEW
	09	43016		50	43048		1204	43018 NEW
	10	43020		60	43052		1205	43019 NEW
	14	43006 NEW		65	43056		1206	43025 NEW
	15	43024		70	43060		1207	43026 NEW
	19	43007 NEW		75	43064		1208	43027 NEW
	20	43028		77	43011 NEW		1209	43029 NEW
TPZ/47/CV	26	43008 NEW		78	43066		1210	43030 NEW
	30	43032		80	43068		1211	43031 NEW
	31	43009 NEW		89	43012 NEW		1212	43033 NEW
	38	43034		90	43070		1213	43035 NEW
	39	43010 NEW		91	43013 NEW		1214	43037 NEW
	40	43036		580	43014 NEW		1215	43039 NEW
	42	43038		1201	43015 NEW		1216	43041 NEW
	45	43040		1202	43016 NEW		1217	43043 NEW
<i>euro/pc</i>								

individually packed

UNISYSTEM PLUS

length = 90 cm - pack 10 pcs / blister

ART. finishing	TPZ/47/CV	TPZ/410/CV	TPZ/413/CV	
floor thickness from/to mm	6,5 / 10	9,6 / 12,5	12,6 / 15,5	
ANODISED ALUMINIUM				
silver		43000	43072	43144
gold		43004	43076	43148
<i>euro/pc</i>				

individually packed

For a single piece, see sales conditions on page 305

Profiles of 90 cm length: the base is already included in the blister pack

unisystem - unisystem plus



C/ are connection profiles for floors of different height. They allow the expansion of wooden or laminate floating floors with thicknesses from 6,5 to 22,6 mm. There is the possibility to choose the base, Unisystem and Unisystem Plus, according to the thickness of the floor.

C/7/SF aluminium covered with Alcrom® Plus film

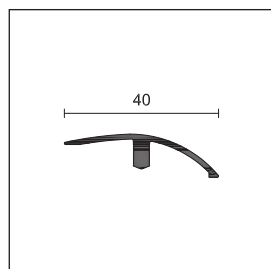

C/7/SF

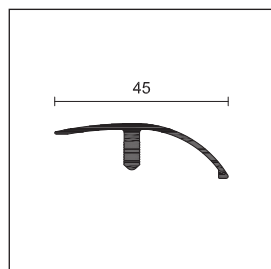

C/10/SF

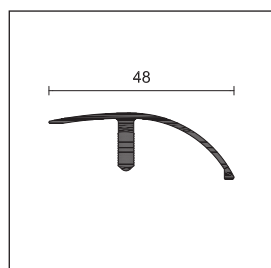

C/13/SF

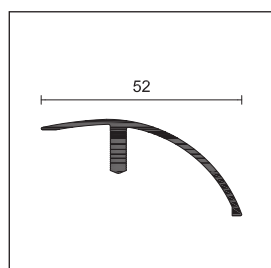

C/22/SF

UNISYSTEM/UNISYSTEM PLUS

length = 270 cm - pack 10 pcs - for floor thicknesses from 6,5 to 10 mm

ART. finishing

ALUMINIUM - decorsALCROM® PLUS

	02	66001		47	66044		670	66102	NEW
	04	66002		48	66045		716	66103	NEW
	05	66006		50	66047		848	66104	NEW
	07	66003		60	66057		866	66105	NEW
	08	66004		65	66065		884	66106	NEW
	09	66005		70	66067		912	66107	NEW
	10	66007		71	66068		951	66108	NEW
	11	66008		72	66069		975	66109	NEW
	12	66009		73	66070		1024	66110	NEW
	13	66010		74	66071		1033	66111	NEW
	14	66011		75	66075		1042	66112	NEW
	15	66015		76	66074		1078	66113	NEW
	18	66016		77	66072		1090	66114	NEW
	19	66018		78	66076		1201	66115	NEW
	20	66017		79	66073		1202	66116	NEW
	25	66020		80	66077		1203	66117	NEW
C/7/SF	26	66021		81	66078		1204	66118	NEW
	30	66027		89	66086		1205	66119	NEW
	31	66028		90	66087		1206	66120	NEW
	32	66029		91	66088		1207	66121	NEW
	34	66031		92	66089		1208	66122	NEW
	35	66032		93	66090		1209	66123	NEW
	36	66033		94	66091		1210	66124	NEW
	37	66034		95	66092		1211	66125	NEW
	38	66035		351	66093	NEW	1212	66126	NEW
	39	66036		363	66094	NEW	1213	66127	NEW
	40	66037		372	66095	NEW	1214	66128	NEW
	41	66038		374	66096	NEW	1215	66129	NEW
	42	66039		490	66097	NEW	1216	66130	NEW
	43	66040		560	66098	NEW	1217	66131	NEW
	44	66041		580	66099	NEW			
	45	66043		590	66100	NEW	100	66132	NEW
	46	66042		665	66101	NEW			

euro/m

individually packed

UNISYSTEM PLUS

length = 270 cm	pack 20 pcs	pack 10 pcs	pack 10 pcs	pack 10 pcs
ART. finishing	C/7/SF	C/10/SF	C/13/SF	C/22/SF
floor thicknesses from/to mm	6,5 / 10	9,6 / 12,5	12,6 / 15,5	15 / 22,6

ANODISED ALUMINIUM

silver		67007	67077	67147	66907
gold		67017	67087	67157	66917
gold sand		67024	-	-	-
bronze		67027	-	-	-
titanium		67000	-	-	-

euro/m

individually packed

For a single piece, see sales conditions on page 305

Profiles of 270 cm length: please order the base separately.

Customized PDS decors on request, see page 220

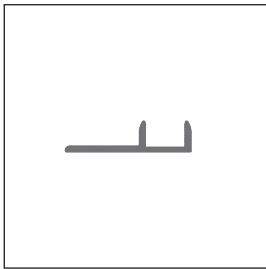

TPU/

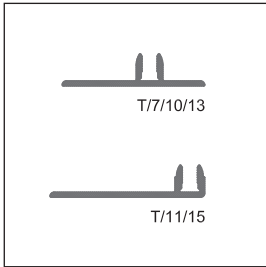

T/

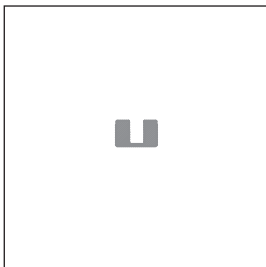

TU/6

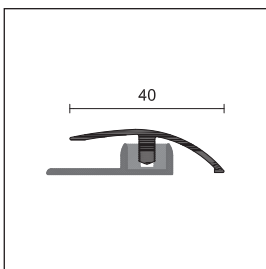

TPC/47/CV

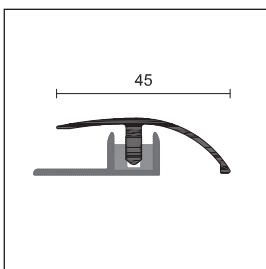

TPC/410/CV

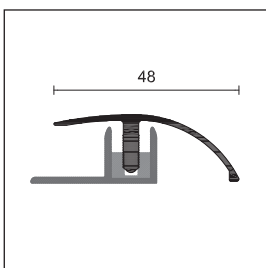

TPC/413/CV

UNISYSTEM PLUS - BASES		C/7	C/10	C/13	C/22	C/22
floor thickness from / to mm		6,5/10	9,6/12,5	12,6/15,5	15/19	19,6/22,6
length = 270 cm pack 20 pcs (15 clips TU/6 included)		H				
ART.	finishing	6	10	13	15	22
ALUMINIUM						
TPU/	natural aluminium		67437	67447	67457	67460
		<i>euro/m</i>				

individually packed (art. TPU/22 pack 10 pcs)

UNISYSTEM - BASES		C/7	C/10	C/13	C/22	
floor thickness from / to mm		6,5/10	10/12	12,5/15	18/22	
length = 270 cm - pack 20 pcs		H				
ART.	finishing	7	10	11	13	
ALUMINIUM						
T/	natural aluminium		67287	67297	67317	67307
		<i>euro/m</i>				

SPARE CLIPS

pack of 150 pcs		H			
		6			
TU/6		68812/150			
		<i>euro/pack</i>			

no partial packaging

UNISYSTEM PLUS

length = 90 cm - pack 10 pcs/blister - for floor thicknesses from 6,5 to 10 mm

ART.	finishing	ALUMINIUM - decors ALCROM® PLUS										
			05	43219	NEW		48	43258		1203	43232	NEW
			09	43230			50	43262		1204	43233	NEW
			10	43234			60	43266		1205	43235	NEW
			14	43220	NEW		65	43270		1206	43236	NEW
			15	43238			70	43274		1207	43237	NEW
			19	43221	NEW		75	43278		1208	43239	NEW
			20	43242			77	43225	NEW	1209	43240	NEW
TPC/47/CV			26	43222	NEW		78	43280		1210	43241	NEW
			30	43246			80	43282		1211	43243	NEW
			31	43223	NEW		89	43226	NEW	1212	43244	NEW
			38	43248			90	43284		1213	43245	NEW
			39	43224	NEW		91	43227	NEW	1214	43247	NEW
			40	43250			580	43228	NEW	1215	43249	NEW
			42	43252			1201	43229	NEW	1216	43251	NEW
			45	43254			1202	43231	NEW	1217	43253	NEW
		<i>euro/pc</i>										

individually packed

UNISYSTEM PLUS

length = 90 cm - pack 10 pcs / blister

ART.	finishing	TPC/47/CV	TPC/410/CV	TPC/413/CV
floor thickness from/to mm		6,5 / 10	9,6 / 12,5	12,6 / 15,5
ANODISED ALUMINIUM				
silver		43214	43286	43358
gold		43218	43290	43362
		<i>euro/pc</i>		

individually packed

For a single piece, see sales conditions on page 305

Profiles of 90 cm length: the base is already included in the blister pack

unisystem - unisystem plus



S/9 and S/15 are perimeter profiles for floors. They allow the expansion of wooden or laminate floating floors with thicknesses from 6,5 to 22,6 mm. There is the possibility to choose the Unisystem Plus base according to the thickness of the floor.

S/9/SF aluminium covered with Alcrom® Plus film

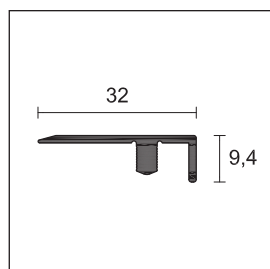

S/9/SF

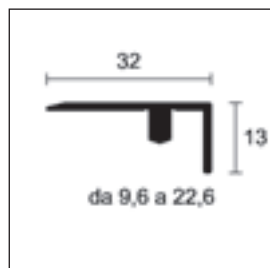

S/15/SF

UNISYSTEM/UNISYSTEM PLUS

length = 270 cm - pack 10 pcs - for floor thicknesses from 6,5 to 22,6 mm

ART. finishing

ALUMINIUM - decorsALCROM® PLUS

	02	65701		46	65742		1033	65800	NEW
	04	65702		47	65744		1042	65801	NEW
	05	65706		48	65745		1078	65802	NEW
	07	65703		50	65747		1090	65803	NEW
	08	65704		60	65757		1201	65804	NEW
	09	65705		65	65765		1202	65805	NEW
	10	65707		70	65767		1203	65806	NEW
	11	65708		71	65768		1204	65807	NEW
	12	65709		72	65769		1205	65808	NEW
	13	65710		73	65770		1206	65809	NEW
	14	65711		74	65771		1207	65810	NEW
	15	65715		75	65775		1208	65811	NEW
	18	65716		76	65774		1209	65812	NEW
	19	65718		77	65772		1210	65813	NEW
	20	65717		78	65776		1211	65814	NEW
S/9/SF	25	65720		79	65773		1212	65815	NEW
	26	65721		80	65777		1213	65816	NEW
	30	65727		81	65778		1214	65817	NEW
	31	65728		89	65784		1215	65818	NEW
	32	65729		90	65785		1216	65819	NEW
	34	65731		91	65786		1217	65820	NEW
	35	65732		92	65789				
	36	65733		93	65790				
	37	65734		94	65791				
	38	65735		95	65792				
	39	65736		580	65793	NEW			
	40	65737		665	65794	NEW			
	41	65738		670	65795	NEW			
	42	65739		912	65796	NEW			
	43	65740		951	65797	NEW			
	44	65741		975	65798	NEW			
	45	65743		1024	65799	NEW			

euro/m

individually packed

UNISYSTEM PLUS

length = 270 cm

pack 20 pcs

pack 10 pcs

ART.	finishing	S/9/SF	S/15/SF
floor thickness from/to mm		6,5/22,6	9,6/22,6
ANODISED ALUMINIUM			
silver		65680	65480
gold		65685	65485
gold sand		65688	65488
bronze		65690	-
titanium		65691	-

euro/m

individually packed

For a single piece, see sales conditions on page 305

Profiles of 270 cm length: please order the base separately.

Customized PDS decors on request, see page 220

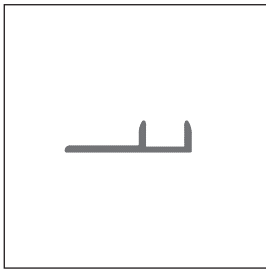

TPU/

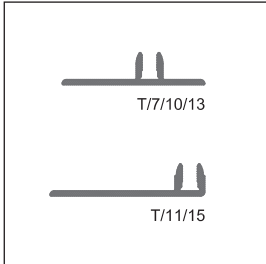

T/

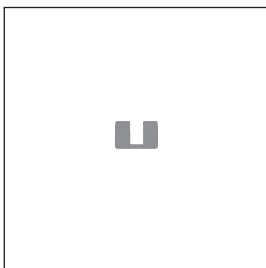

TU/6

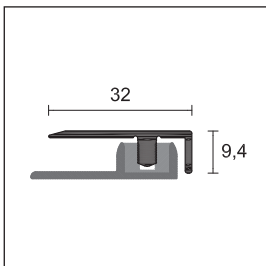

TPS/47/CV

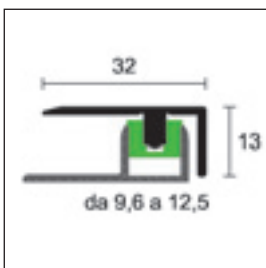

TPS/410/CV

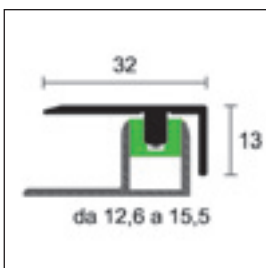

TPS/413/CV

UNISYSTEM PLUS - BASES

floor thickness from / to mm	6,5/10	9,6/12,5	12,6/15,5	15/19	19,6/22,6	
length = 270 cm pack 20 pcs (15 clips TU/6 included)	H					
ART. finishing	6	10	13	15	22	
ALUMINIUM						
TPU/ natural aluminium		67437	67447	67457	67460	67467
<i>euro/m</i>						

individually packed (art. TPU/22 pack 10 pcs)

UNISYSTEM - BASES

floor thickness from / to mm	6,5/10	10,12	6,5/10	13/15	11/15	
length = 270 cm - pack 20 pcs	H					
ART. finishing	7	10	11	13	15	
ALUMINIUM						
T/ natural aluminium		67287	67297	67317	67307	67327
<i>euro/m</i>						

SPARE CLIPS

pack of 150 pcs	H				
	6				
TU/6	68812/150				

euro/pack

no partial packaging

UNISYSTEM PLUS

length = 90 cm - pack 10 pcs / blister				
ART. finishing	TPS/47/CV	TPS/410/CV	TPS/413/CV	
floor thickness from/to mm	6,5 / 10	9,6 / 12,5	12,6 / 15,5	
ANODISED ALUMINIUM				
silver		43430	43502	43574
gold		43434	43506	43578
<i>euro/pc</i>				

individually packed

Profiles of 90 cm length: the base is already included in the blister pack

For a single piece, see sales conditions on page 305

unisystem - unisystem plus



G/2/SF aluminium covered with Alchrom® Plus film

G/2/SF is a stair nosing profile of Unisystem Plus line. Composed of a base and a top profile, it is suitable for the installation of wooden and laminate floors with thicknesses from 6,5 to 12,5 mm. According to the thickness of the floor, there is the possibility to choose the specific base profile TPU/.



G/2/SF

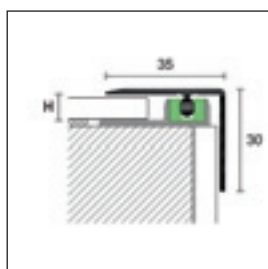

G/2/SF + TPU/

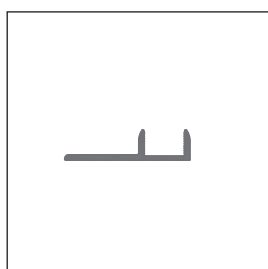

TPU/

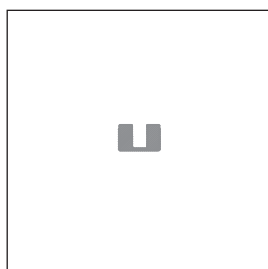

TU/6

UNISYSTEM/UNISYSTEM PLUS

length = 270 cm - pack 10 pcs - for floor thicknesses from 6,5 to 12,5 mm

ART. finishing

ALUMINIUM - decors ALCROM® PLUS

NEW G/2/SF		05	43645		77	43657		1208	43669
		08	43646		89	43658		1209	43670
		12	43647		91	43659		1210	43671
		13	43648		93	43660		1211	43672
		14	43649		580	43661		1212	43673
		19	43650		1201	43662		1213	43674
		26	43651		1202	43663		1214	43675
		32	43652		1203	43664		1215	43676
		36	43653		1204	43665		1216	43677
		39	43654		1205	43666		1217	43678
		40	43655		1206	43667			
		41	43656		1207	43668			

euro/m

individually packed

UNISYSTEM/UNISYSTEM PLUS

length = 270 cm - pack 10 pcs - for floor thicknesses from 6,5 to 12,5 mm

ART. finishing

ANODISED ALUMINIUM

NEW G/2/SF		silver		43690
		titanium		43691

euro/m

individually packed

UNISYSTEM PLUS - BASES

floor thickness from / to mm

6,5/10

9,6/12,5

length = 270 cm
pack 20 pcs (15 clips TU/6 included)

H

ART. finishing

6

10

ALUMINIUM

TPU/	natural aluminium		67437	67447
------	-------------------	--	-------	-------

euro/m

individually packed

SPARE CLIPS

pack 150 pcs

H

6

TU/6

68812/150

euro/pack

no partial packaging

For a single piece, see sales conditions on page 305

Customized PDS decors on request, see page 220

Profiles of 270 cm length: please order the base separately.

profiles for wooden and laminate floors

unisystem - unisystem plus



G/4/SF aluminium covered with Alchrom® Plus film

G/4 are stair nosing profiles. They allow the expansion of wooden or laminate floating floors with thicknesses from 6,5 to 15,5 mm. There is the possibility to choose the Unisystem Plus base according to the thickness of the floor.

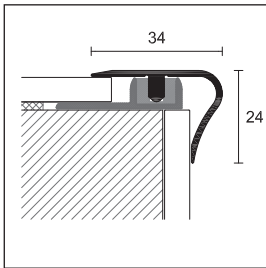

G/4/SF

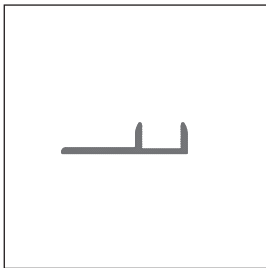

TPU/

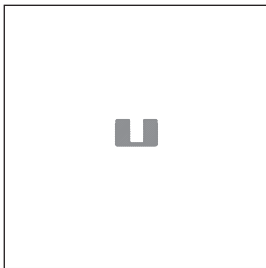

TU/6

UNISYSTEM/UNISYSTEM PLUS

length = 270 cm - pack 10 pcs - for floor thicknesses from 6,5 to 15,5 mm

ART. finishing

ALUMINIUM - decors ALCROM® PLUS

	02	63905		36	63942		72	63952
	04	63909		37	63943		73	63953
	07	63906		38	63919		74	63954
	08	63907		40	63920		75	63933
	09	63908		41	63926		76	63956
	10	63910		42	63921		77	63937
	11	63911		43	63927		78	63934
	12	63913		44	63929		79	63938
G/4/SF	13	63916		45	63922 *		80	63935
	15	63912		46	63936 *		81	63939
	18	63914		48	63925		90	63940
	20	63915		50	63928 *		92	63941
	30	63918 *		60	63930		93	63944
	32	63917		65	63931		94	63945
	34	63923		70	63932		95	63946
	35	63924		71	63951			

euro/m

individually packed

UNISYSTEM/UNISYSTEM PLUS

length = 270 cm - pack 10 pcs - for floor thicknesses from 6,5 to 15,5 mm

ART. finishing

ANODISED ALUMINIUM

	silver		63900
G/4/SF	gold		63902
	titanium		63904

euro/m

individually packed

UNISYSTEM PLUS - BASES

floor thickness from / to mm 6,5/10 9,6/12,5 12,6/15,5

length = 270 cm
pack 20 pcs (15 clips TU/6 included)

ART. finishing 6 10 13

ALUMINIUM

TPU/ natural aluminium 67437 67447 67457

euro/m

individually packed

SPARE CLIPS

pack 150 pcs

H

6

TU/6 68812/150

euro/pack

no partial packaging

* Out of production items, available till end of stock

For a single piece, see sales conditions on page 305

Profiles of 270 cm length: please order the base separately.

Customized PDS decors on request, see page 220

profix thin

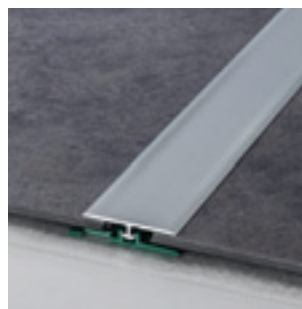

Z/4 silver anodised aluminium

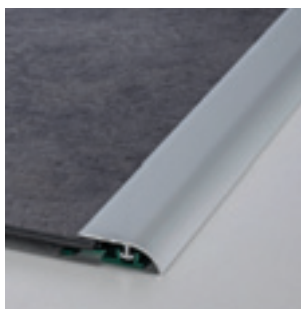

C/4 silver anodised aluminium

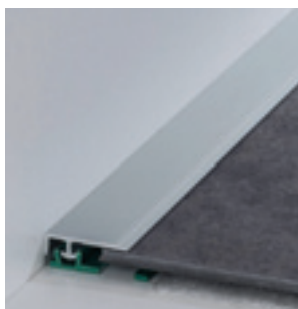

S/4 silver anodised aluminium

Profix Thin is a system for the floating laying of LVT floors from 4 mm to 6 mm. The junction profile Z/4, the connection profile C/4 and the sealing profile S/4 are available in anodised finish and covered by Alcrom® Plus. The top profiles need to be interlocked on the PVC base.

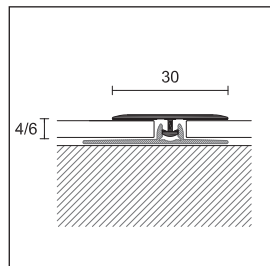

Z/4 + PT/4

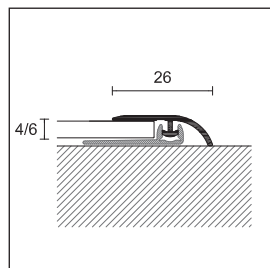

C/4 + PT/4/SA

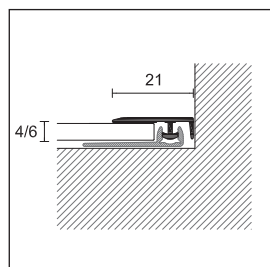

S/4 + PT/4/SA

PROFIX THIN

length = 270 cm - pack 20 pcs

for floor thickness (from 4 to 6 mm)

decors ALCROM® PLUS

		Z/4	C/4	S/4			Z/4	C/4	S/4
	1003	85101	85201	85301		1060	85120	85220	85320
	1006	85102	85202	85302		1063	85121	85221	85321
	1009	85103	85203	85303		1066	85122	85222	85322
	1012	85104	85204	85304		1069	85123	85223	85323
	1015	85105 *	85205 *	85305 *		1072	85124 *	85224 *	85324 *
	1018	85106 *	85206 *	85306 *		1075	85125 *	85225 *	85325 *
	1021	85107	85207	85307		1078	85126 *	85226 *	85326 *
	1024	85108	85208	85308		1081	85127	85227	85327
	1027	85109 *	85209 *	85309 *		1084	85128	85228	85328
	1030	85110	85210	85310		1087	85129	85229	85329
	1033	85111	85211	85311		1090	85130	85230	85330
	1036	85112	85212	85312		1093	85131 *	85231 *	85331 *
	1039	85113 *	85213 *	85313 *		1096	85132 *	85232 *	85332 *
	1042	85114	85214	85314		1099	85133 *	85233 *	85333 *
	1045	85115	85215	85315		1102	85134 *	85234 *	85334 *
	1048	85116 *	85216 *	85316 *		1105	85135	85235	85335
	1051	85117	85217	85317		1108	85136	85236	85336
	1054	85118	85218	85318		1111	85137	85237	85337
	1057	85119	85219	85319		1114	85138 *	85238 *	85338 *

euro/m





individually packed

* Out of production items, available till end of stock

Customized PDS decors on request, see page 220

For a single piece, see sales conditions on page 305
203

PROFIX THIN

length = 270 cm - pack 20 pcs		for floor thickness (from 4 to 6 mm)		
ART.		Z/4	C/4	S/4
finishing				
ANODISED ALUMINIUM				
silver		85050	85060	85070
<i>euro/m</i>				
gold sand		85052	85062	85072
titanium		85054	85064	85074
<i>euro/m</i>				
bronze elox		85056	85066	85076
<i>euro/m</i>				

PROFIX THIN - BASES

length = 270 cm - pack 20 pcs		for floor thickness (from 4 to 6 mm)	
ART.		PT/4	PT/4/SA
finishing			
PVC			
green		85081	85083
<i>euro/m</i>			

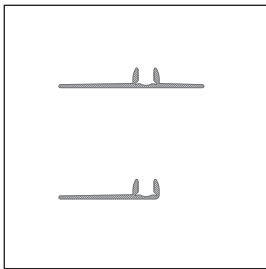

PT/4
PT/4/SA

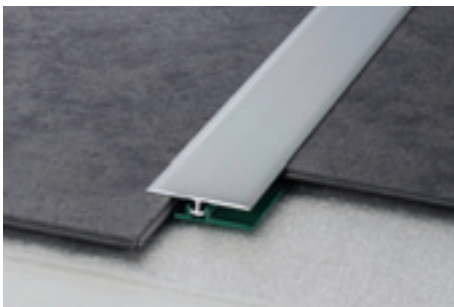

Z/4 + PT/4

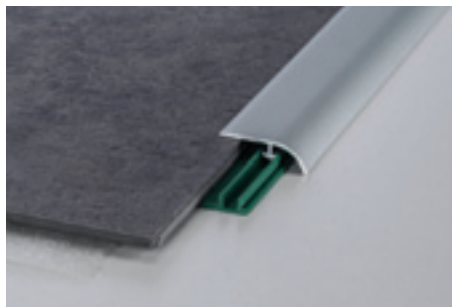

C/4 + PT/4/SA

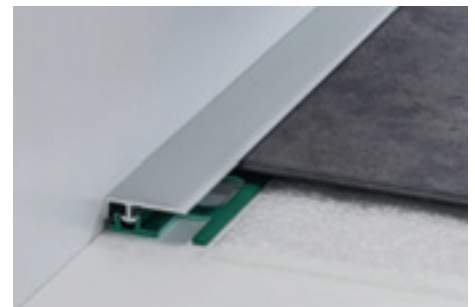

S/4 + PT/4/SA

To order PT/4 and PT/4/ SA in pack of 100 pcs mark /100 after the article code (for example code 85081 becomes 85081/100). Pack of 100 pcs of PT/4 and PT/4/SA €/pc

For a single piece, see sales conditions on page 305

prestowood



22/A aluminium covered with Alcrom® Plus film

Prestowood 22/A, 50/A and 23/A are adhesive profiles for wooden floors of same level, different level and stairs that have been already installed. In anodised aluminium, or covered with Alcrom® Plus film, they are particularly easy and quick to install, thus becoming suitable also for the DIY.

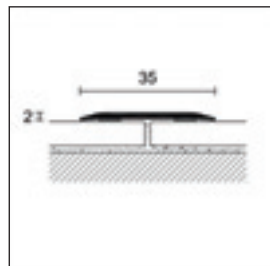

422/AD
22/A

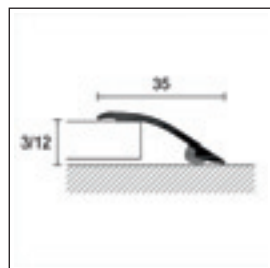



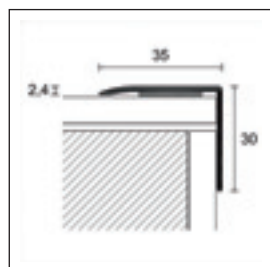

































450/AD
50/A



63/A



























NEW PRESTOWOOD

pack	10 pcs / blister 	10 pcs	10 pcs / blister 	10 pcs	10 pcs	
length cm	90	270	90	270	270	
ART.	422/AD	22/A	450/AD	50/A	63/A	
ALUMINIUM - decors ALCROM® PLUS						
	05	43700	43932	44949	45031	45140
	08	43701	43933	44950	45032	45141
	12	43702	43934	44951	45033	45142
	13	43703	43935	44952	45034	45143
	14	43704	43936	44953	45035	45144
	19	43705	43937	44954	45036	45145
	26	43706	43938	44955	45037	45146
	31	43707	43939	44956	45038	-
	32	43708	43940	44957	45039	45147
	34	43709	43941	44958	45040	-
	36	43710	43942	44959	45041	45148
	39	43711	43943	44960	45042	45149
	40	43712	43944	44961	45043	45150
	41	43713	43945	44962	45044	45151
	73	43714	43946	44963	45045	-
	74	43715	43947	44964	45046	-
	77	43716	43948	44965	45047	45152
	79	43717	43949	44966	45048	-
	81	43718	43950	44967	45049	-
	89	43719	43951	44968	45050	45153
	91	43720	43952	44969	45051	45154
	92	43721	43953	44970	45052	-
	93	43762	43995	45013	45094	45155
	94	43722	43954	44971	45053	-
	351	43723	43955	44972	45054	-
	363	43724	43956	44973	45055	-
	372	43725	43957	44974	45056	-
	374	43726	43958	44975	45057	-
	490	43727	43959	44976	45058	-
	560	43728	43960	44977	45059	-
	580	43729	43961	44978	45060	45156
	590	43730	43962	44979	45061	-
	665	43731	43963	44980	45062	-
	670	43732	43964	44981	45063	-
	716	43733	43965	44982	45064	-
	848	43734	43966	44983	45065	-
	866	43735	43967	44984	45066	-
	884	43736	43968	44985	45067	-
	912	43737	43969	44986	45068	-





 packaging in blister no partial packaging

422/AD, 450/AD and 63/A are available just for Spain and Portugal

For a single piece, see sales conditions on page 305

pack	10 pcs / blister 	10 pcs	10 pcs / blister 	10 pcs	10 pcs
length cm	90	270	90	270	270
ART.	422/AD	22/A	450/AD	50/A	63/A
ALUMINIUM - decors ALCROM® PLUS					
 951	43738	43970	44987	45069	-
 975	43739	43971	44988	45070	-
 1024	43740	43972	44989	45071	-
 1033	43741	43973	44990	45072	-
 1042	43742	43974	44991	45073	-
 1078	43743	43975	44992	45074	-
 1090	43744	43976	44993	45075	-
 1201	43745	43977	44994	45076	45157
 1202	43746	43978	44995	45077	45158
 1203	43747	43979	44996	45078	45159
 1204	43748	43980	44997	45079	45160
 1205	43749	43981	44998	45080	45161
 1206	43750	43982	44999	45081	45162
 1207	43751	43983	45000	45082	45163
 1208	43752	43984	45001	45083	45164
 1209	43753	43985	45002	45084	45165
 1210	43754	43986	45003	45085	45166
 1211	43755	43987	45004	45086	45167
 1212	43756	43988	45005	45087	45168
 1213	43757	43989	45007	45088	45169
 1214	43758	43990	45008	45089	45170
 1215	43759	43991	45009	45090	45171
 1216	43760	43992	45010	45091	45172
 1217	43761	43993	45011	45092	45173
 100	-	43994	-	45093	-
euro/pc					
euro/m					
individually packed					

NEW PROCLASSIC F / PROLEVEL HIGH / PROTECT

pack	10 pcs / blister 	10 pcs	10 pcs / blister 	10 pcs	10 pcs
length cm	90	270	90	270	270
ART.	422/AD	22/A	450/AD	50/A	63/A
ANODISED ALUMINIUM					
 silver	43790	44000	45019	45100	45190
euro/pc					
euro/m					
 titanium	43791	44001	45020	45101	45191
euro/pc					
euro/m					
individually packed					



50/A titanium anodised aluminium

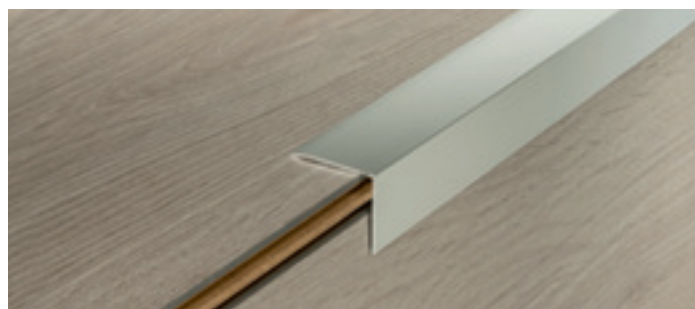

63/A silver anodised aluminium

prestowood



Prestowood 74/ A and 58 / A is a line of adhesive profiles of quick and easy installation, for wood stairs already laid. Made of anodised aluminium or foiled with Alcron® Plus film, they are particularly suitable in the DIY installation.

74/A aluminium covered with Alcron® Plus film

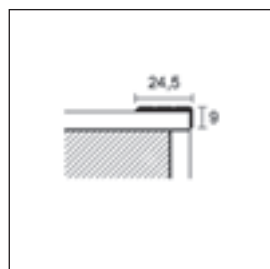

73/

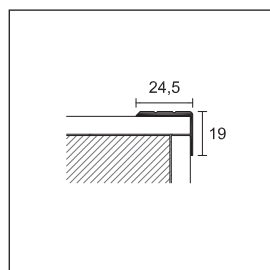

74/A

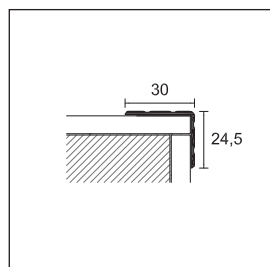





58/A

PRESTOWOOD

pack	10 pcs	10 pcs / blister	10 pcs
length cm	270	90	270
ART.	74/A	474/AD	58/A
finishing			
ALUMINIUM - decors ALCROM® PLUS			
09	75290	21543 *	
10	75319	21535 *	75920 *
12	75297		
13	75301		
15	75291	21544 *	
20	75320	21536 *	75930 *
25	75302		
32	75303		
36	75304		
37	75305		
38	75306		
40	75322	21538 *	75940 *
45	75292	21545 *	
47	75307		
48	75293	21546 *	
50	75323	21539 *	75950 *
60	75324	21540 *	75960 *
65	75294	21547 *	
70	75325	21541 *	
71	75309		
75	75295	21548 *	
76	75334		
78	75311		
80	75326	21542 *	75980 *
90	75296	21549 *	
92	75312		
94	75313		
95	75314		
euro/m			
euro/pc			

individually packed

PROTECT

pack	30 pcs						20 pcs	
length cm	270							
ART.	73/			74/			58/	
finishing	F	SF	A	F	SF	A	A	
ALUMINIUM								
silver anodised		75208	75209	75238	75268	75269	75298	75900
gold anodised		75218	75219 *	75248	75278	-	75308	75910 *
bronze anodised		75228 *	-	75258	75288 *	-	75318	
euro/m								
titanium anodised							75299	
euro/m								
colour-coated anthracite grey RAL 7016							75300 *	
euro/m								

* Out of production items, available till end of stock

For a single piece, see sales conditions on page 305

Customized PDS decors on request, see page 220

 packaging in blister no partial packaging



RC/9/F silver anodised aluminium

RC/ is a line of border profiles for the laying of floating wooden and laminate floors. RC/ are also available in Flex version. See page 232.

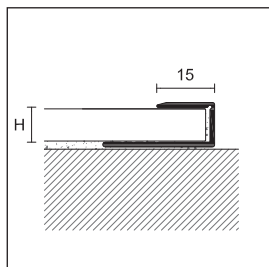

RC/ /F

RC

length = 270 cm - pack 20 pcs

ART.	finishing	7	9	11	13	15	
ALUMINIUM							
	silver anodised		67407	67477	67547	67617	67687
RC/ /F	gold anodised		-	67487	-	-	-
	bronze anodised		-	67497	-	-	-
euro/m							

length = 270 cm - pack 10 pcs

ART.	finishing	7	9	11	13	15
ALUMINIUM - decors ALCROM® PLUS						
	09	-	66729	-	-	-
	10	-	66731	-	-	-
	15	-	66732	-	-	-
	20	-	66734	-	-	-
	30	-	66737	-	-	-
	38	-	66739	-	-	-
	40	-	66740	-	-	-
	42	-	66758	-	-	-
RC/ /F	45	-	66741	-	-	-
	48	-	66742	-	-	-
	50	-	66743	-	-	-
	60	-	66746	-	-	-
	65	-	66747	-	-	-
	70	-	66749	-	-	-
	75	-	66750	-	-	-
	78	-	66751	-	-	-
	80	-	66752	-	-	-
	90	-	66753	-	-	-
euro/m						

RC

length = 90 cm - pack 10 pcs / blister

ART.	finishing	7	9	11	15	
		RC/47/CV	RC/49/CV	RC/411/CV	RC/415/CV	
ALUMINIUM						
	silver anodised		42782	41832	41877	42822
	gold anodised		-	41839	-	-
euro/pc						

For a single piece, see sales conditions on page 305

Customized PDS decors on request, see page 220

alfix 616





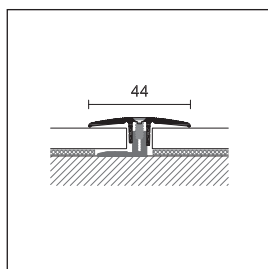

Alfix 616 is a professional system for the laying of wooden and laminate floors with thickness from 6 to 16 mm. The system is composed of a top profile in anodised aluminium fixed with screws on a natural aluminium base. The screws, included in the packaging, have the same colour of the top profile in order to perfectly match it.

FIX/L/55 silver anodised aluminium



FIX/J/44



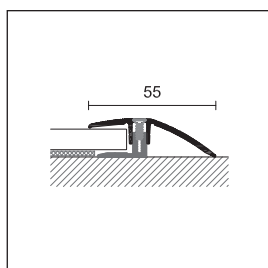

ALFIX 616

pack	10 pcs	10 pcs / blister 	
length cm	270	90	100
ART.	FIX/J/44		
for floor thicknesses from 6 to 16 mm			
finishing			
ALUMINIUM			
silver anodised		37010	37012 37014
sand gold anodised		37210	37212 37214 *
euro/m		-	-
euro/pc		-	-
titanium anodised		37410	37412 * 37414
elox bronze anodised		37310	37312 37314
euro/m		-	-
euro/pc		-	-
individually packed			



FIX/L/55



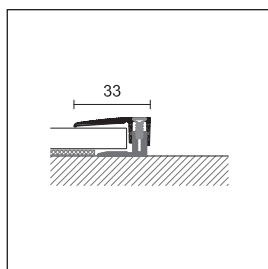

ALFIX 616

pack	10 pcs	10 pcs / blister 	
length cm	270	90	100
ART.	FIX/L/55		
for floor thicknesses from 6 to 16 mm			
finishing			
ALUMINIUM			
silver anodised		37040	37042 37044
sand gold anodised		37240	37242 37244
euro/m		-	-
euro/pc		-	-
titanium anodised		37440	37442 37444
elox bronze anodised		37340	37342 * 37344 *
euro/m		-	-
euro/pc		-	-
individually packed			



FIX/T/33

ALFIX 616

pack	10 pcs	10 pcs / blister 	
length cm	270	90	100
ART.	FIX/T/33		
for floor thicknesses from 6 to 16 mm			
finishing			
ALUMINIUM			
silver anodised		37070	37072 * 37074
sand gold anodised		37270	37272 37274 *
euro/m		-	-
euro/pc		-	-
titanium anodised		37470	37472 * 37474
elox bronze anodised		37370 *	37372 * 37374
euro/m		-	-
euro/pc		-	-
individually packed			

For a single piece, see sales conditions on page 305

 packaging in blister no partial packaging



FIX/J/30 silver anodised aluminium



FIX/L/32 silver anodised aluminium



FIX/T/19 silver anodised aluminium

Alfix 46 is a professional system for the laying of LVT floors from 4 to 6 mm. This system is characterized by top profiles in anodised aluminium, fixed with a screw system on a natural aluminium base. Screws, included in the package, have the same colour of the anodisation and, once fixed, integrate with the top profile.

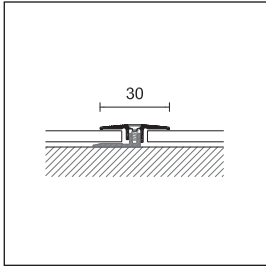

FIX/J/30

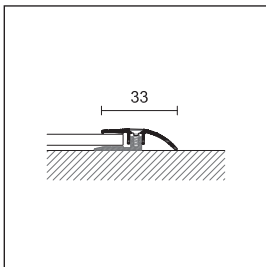

FIX/L/32

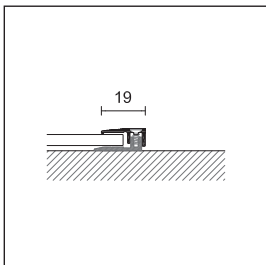

FIX/T/19

ALFIX 46

pack	10 pcs
length cm	270
ART.	FIX/J/30
for floor thicknesses from 4 to 6 mm	
finishing	
ALUMINIUM	
silver anodised	 35500
euro/m	
individually packed	

ALFIX 46

pack	10 pcs
length cm	270
ART.	FIX/L/32
for floor thicknesses from 4 to 6 mm	
finishing	
ALUMINIUM	
silver anodised	 35510
euro/m	
individually packed	

ALFIX 46

pack	10 pcs
length cm	270
ART.	FIX/T/19
for floor thicknesses from 4 to 6 mm	
finishing	
ALUMINIUM	
silver anodised	 35520
euro/m	
individually packed	

cerfix® projoint - pronivel



NZA/5A silver anodised aluminium

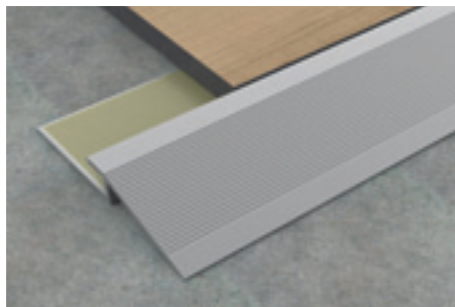

PBA/5A silver anodised aluminium

NZA/ is an expansion joint in aluminium composed of two interlocking and sliding profiles. Suitable for LVT floors and tiles of small gaps, it guarantees a good resistance to loads and intense foot traffic. This item can be 3 mm high and, therefore, suitable for the application on substrate joints in glued LVT; it can also be 5 mm high and, in this case, thanks to the exclusive solution with the adhesive integrated with the internal anchor flange, it can be fixed directly to the board and it is the perfect joint for LVT floating floors with a uninterrupted surface and perfectly flat.

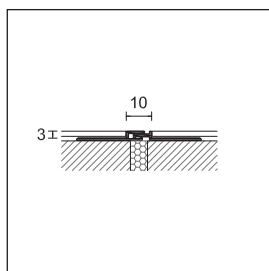

NZA/3

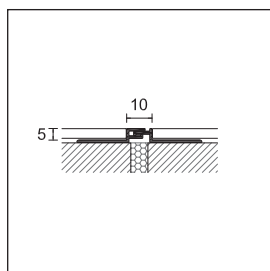

NZA/5

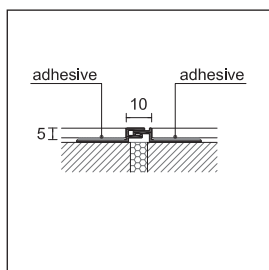

NZA/5A

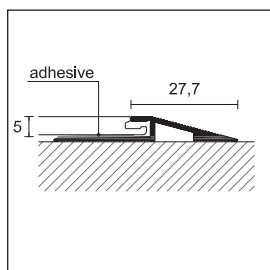

PBA/5A

PROJOINT

length = 270 cm - pack 20 pcs

ART.	finishing	3	5	5A	
ALUMINIUM					
NZA/	silver anodised		99300	99320	99310
	sand gold anodised		-	-	99312
	euro/m				
	titanium anodised		-	-	99314
	elox bronze anodised		-	-	99316
	euro/m				

individually packed

PRONIVEL

length = 270 cm - pack 10 pcs

ART.	finishing	5	
ALUMINIUM			
PBA/5A	silver anodised		93205
euro/m			

individually packed



NTA/3 natural aluminium + EPDM grey



NTI/3 stainless steel + EPDM grey

NTA/ and NTI/ are expansion joints that are also ideal for glued LVT floors and that should be installed in line with the substrate joints.

PROJOINT DIL

length = 270 cm - pack 10 pcs

ART.	finishing	3	
ALUMINIUM			
NTA/	natural aluminium + EPDM grey polishable RAL 7046		99421
	natural aluminium + EPDM black polishable RAL 9005		99422
	euro/m		
	natural aluminium + EPDM bahama polishable RAL 10070		99427
	natural aluminium + EPDM brown polishable RAL 10071		99429
	euro/m		

PROJOINT DIL

length = 270 cm - pack 10 pcs

ART.	finishing	3	
STAINLESS STEEL			
NTI/	stainless steel AISI 304 DIN 1.4301 + EPDM grey RAL 7046		99471
	stainless steel AISI 304 DIN 1.4301 + EPDM black RAL 9005		99472
	euro/m		
	stainless steel AISI 304 DIN 1.4301 + EPDM bahama RAL 10070		99431
	stainless steel AISI 304 DIN 1.4301 + EPDM brown RAL 10071		99433
	euro/m		



H/5/F silver anodised aluminium



PBAS/5/S silver anodised aluminium

H/5/F, PBAS/5/F, RC/5/F and 99/TR/26 are connection profiles in anodised aluminium, for floating LVT floors and suitable as profiles for same height, different height and for borders.

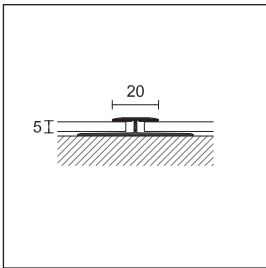

H/5/F

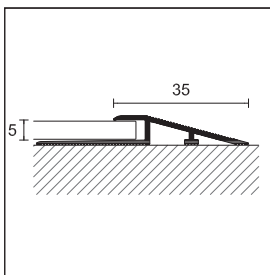

PBAS/5/F

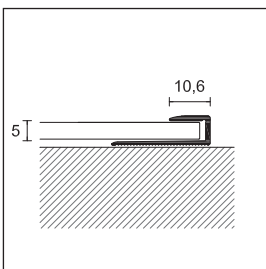

RC/5/F

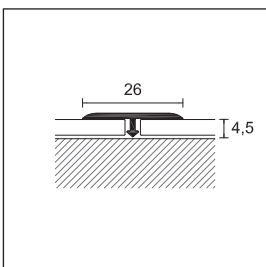

99/TR/26

PROJOINT T

length = 270 cm - pack 20 pcs		H
ART.	finishing	5
ALUMINIUM		
H/5/F drilled	silver anodised	75000
<i>euro/m</i>		
individually packed		

PROVIVEL PB

length = 270 cm - pack 20 pcs		H
ART.	finishing	5
ALUMINIUM		
PBAS/5/F drilled	silver anodised	95203
<i>euro/m</i>		
individually packed		

PROLEVEL MEDIUM

length = 270 cm - pack 20 pcs		H
ART.	finishing	5
ALUMINIUM		
RC/5/F drilled	silver anodised	67475
<i>euro/m</i>		
individually packed		

PROJOINT T

length = 270 cm - pack 20 pcs		LxH
ART.	finishing	26 X 4,5
ALUMINIUM		
99/TR/26	silver anodised	75081
<i>euro/m</i>		
individually packed		

prostep - protect



SMA/4 silver anodised aluminium



75/F silver anodised aluminium

SMA/, 75/F, 11/ /F and G/705/F are profiles in anodised aluminium suitable for stairs covered with glued LVT. ZGF/ is a profile in aluminium suitable for following the curvilinear course of stairs or floors in glued LVT.

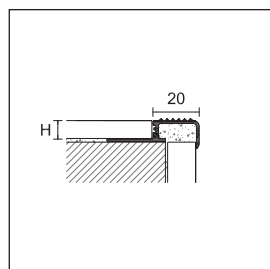

SMA/4

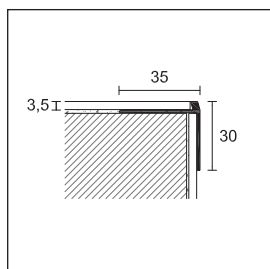

75/F

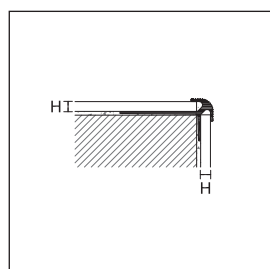

111/

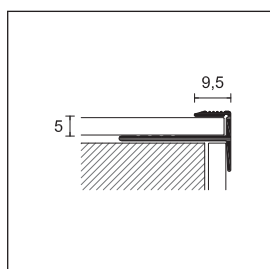

G/705/F

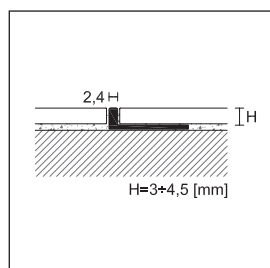

ZGF/

PROSTEP

length = 270 cm - pack 10 pcs		H
ART.	finishing	4,5
ALUMINIUM		
SMA/	natural aluminium	93967
	<i>euro/m</i>	
SMA/	silver anodised	93975
	<i>euro/m</i>	

individually packed

PROTECT

length = 340 cm - pack 20 pcs		H
ART.	finishing	3,5
ALUMINIUM		
75/F	silver anodised	75388
	<i>euro/m</i>	

PROTECT

length = 270 cm - pack 20 pcs		H		
ART.	finishing	2,5	4,5	5
ALUMINIUM				
111/ /F	silver anodised	75782	75784	75785
	<i>euro/m</i>			

PROSTEP

length = 270 cm - pack 10 pcs		H
ART.	finishing	5
ALUMINIUM		
G/705/F	silver anodised	67580
	<i>euro/m</i>	

individually packed

PROANGLE FLEX

length = 270 cm - pack 10 pcs		H
ART.	finishing	4,5
ALUMINIUM		
ZGF/	natural aluminium	88721
	<i>euro/m</i>	



111/2,5/F silver anodised aluminium



G/705/F silver anodised aluminium

cerfix® protrim - proangle



RA/ and RI/ are profiles that are ideal for LVT coverings and are recommended as border profiles for floors or stairs finishing.

RI/4 stainless steel AISI 304 - DIN 1.4301

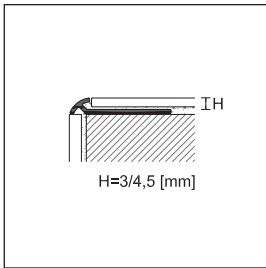

RA/

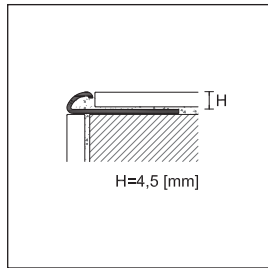

RI/

PROTRIM

length = 270 cm - pack 20 pcs

ART.		finishing		H	
		3	4,5		
ALUMINIUM					
RA/	silver anodised		92055	92056	
	gold anodised		92025	92026	
	titanium anodised		92085	92086	

euro/m
individually packed

PROTRIM

length = 270 cm - pack 20 pcs

ART.		finishing		H	
		4,5			
STAINLESS STEEL					
RI/	stainless steel AISI 304 DIN 1.4301		92413		

euro/m
individually packed



ZA/4 silver anodised aluminium

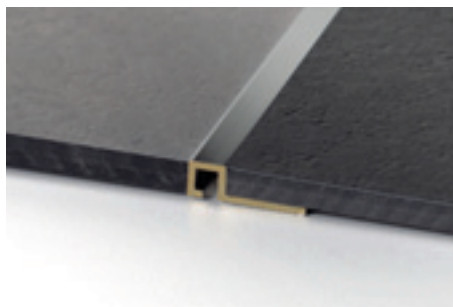

ZQKN/4 chromium-plated brass

ZA/, AI/, ZQAN/, ZQKN/ and ZK/ are profiles suitable for LVT coverings and are recommended as connection and border profiles.

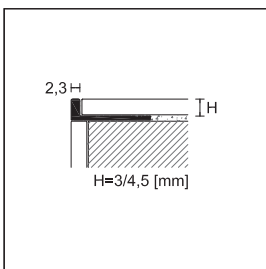

ZA/

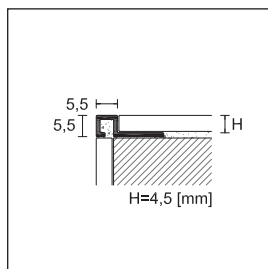

ZQAN/

PROANGLE

length = 270 cm - pack 20 pcs

ART.		finishing		H		
		2,5	3	4,5		
ALUMINIUM						
ZA/	silver anodised		90337	90338	90340	
	euro/m					
STAINLESS STEEL						
AI/	stainless steel AISI 304 DIN 1.4301		-	91636	91638	
euro/m						

individually packed - version chromium - plated brass article ZK/3 and ZK/4,5 see page 76

PROANGLE Q

length = 270 cm - pack 20 pcs

ART.		finishing		H	
		4,5			
ALUMINIUM					
ZQAN/	silver anodised		88772		
	titanium anodised		88902		
euro/m					
BRASS					
ZQKN/	chromium plated		88870		
euro/m					

individually packed

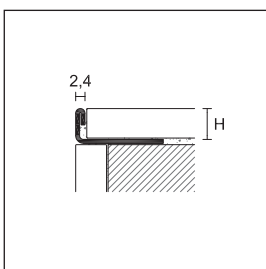

AI/

For a single piece, see sales conditions on page 305



GA/4 silver anodised aluminium



JGA/4 silver anodised aluminium

GA/, JGA/ and PIA/ are connection profiles for stairs in glued LVT. Easy to lay, they facilitate the hygienic maintenance of the connection between tread and riser.

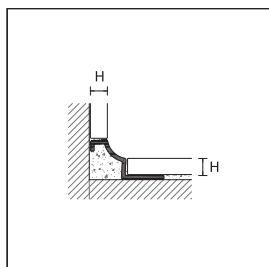

GA/

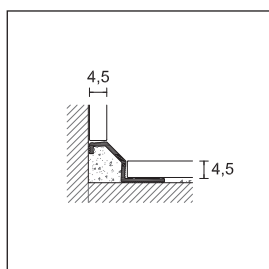

JGA/

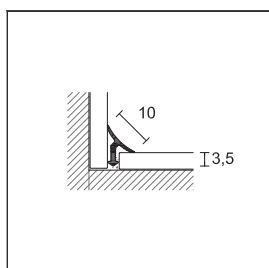

PIA/

PROROUND M

length = 270 cm - pack 20 pcs H

ART.	finishing	3	4,5
-------------	------------------	----------	------------

ALUMINIUM

GA/	silver anodised		95729	95730
------------	-----------------	---	-------	-------

euro/m

individually packed

PROROUND M

length = 270 cm - pack 20 pcs H

ART.	finishing	4,5
-------------	------------------	------------

ALUMINIUM

JGA/	silver anodised		95732
-------------	-----------------	---	-------

euro/m

JGB/	bright polished silver		95733 *
-------------	------------------------	---	---------

euro/m

individually packed

PROINT

length = 270 cm - pack 20 pcs H

ART.	finishing	3,5
-------------	------------------	------------

ALUMINIUM

PIA/	silver anodised		95431
-------------	-----------------	---	-------

euro/m

individually packed

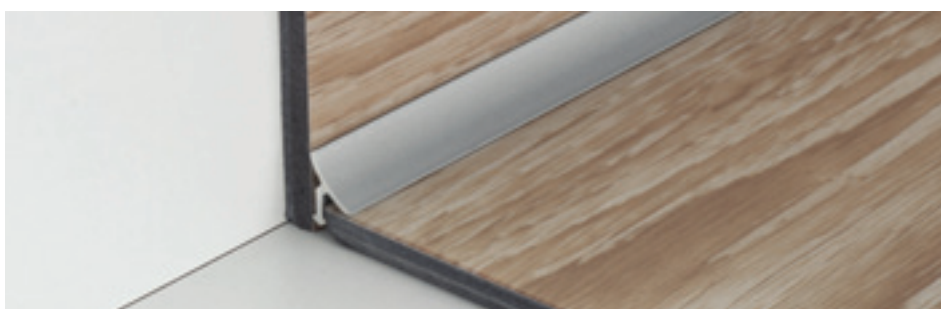

PIA/3 silver anodised aluminium

* Out of production items, available till end of stock
For a single piece, see sales conditions on page 305



8608 foam PVC covered with Alcrom® Plus film

PVC Line 8608 is a foam PVC skirting board, covered with Alcrom® Plus film. Available in 45 decors, it is also customizable with a minimum order of 500 meters. 8608 may be fixed to the wall with its fixing clip, adhesive (PP/96) or with nails; it does not absorb water, it does not contain formaldehyde, it is resistant to the impact, to the wear (certificate AC3), to UV rays and to cleaning products for floors and walls.

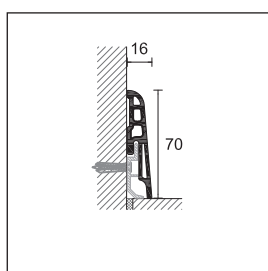

8608

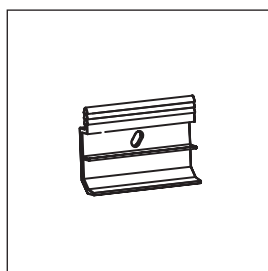

8608/C

PVC LINE

length = 250 cm - pack 20 pcs

FOAM PVC COVERED WITH FILM

H = 70 mm

ART.	decors ALCROM® PLUS		decors ALCROM® PLUS		decors ALCROM® PLUS	
	02	29040	34	29048	76	29060
	05	29075	35	29049	77	29061
	08	29041	36	29050	78	29062
	09	29042	39	29080	80	29063
	10	29043	40	29051	81	29064
	11	29044	41	29052	89	29081
	12	29045	44	29053	90	29065 *
8608	14	29076	46	29054 *	91	29082
	19	29077	47	29073	92	29066
	20	29046	48	29055 *	93	29067 *
	25	29072	50	29056 *	94	29068 *
	26	29078	60	29057 *	95	29069
	31	29079	65	29058	white 96	29070
	32	29047	70	29059 *	black 97	29071

euro/m

		silver 98	29074
8608	NEW	satin silver 99	29083
	NEW	satin steel 100	29084

euro/m

no partial packaging

FIXING CLIPS FOR ITEM 8608

pack of 100 pcs

8608/C	29751
---------------	-------

euro/pack

MS POLYMER-BASED ADHESIVE FOR SKIRTING BOARDS

pack of 24 pcs - quantity 290 ml

PP/96	78301
--------------	-------

euro/pc

output 10/15 m for cartridge

* Out of production items, available till end of stock

For a single piece, see sales conditions on page 305

Customized PDS decors on request, see page 220

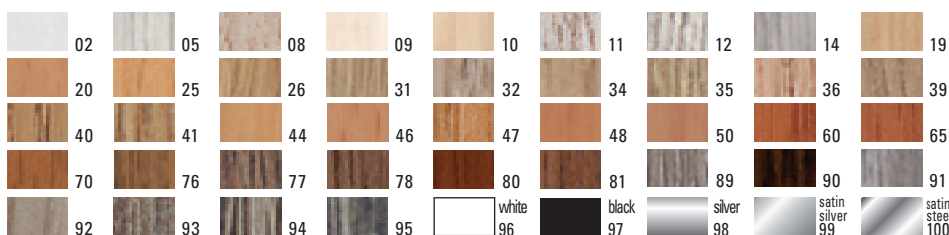



8605 foam PVC covered with Alcrom® Plus film

PVC Line 8605 is a foam PVC skirting board, covered with PDS film. Available in 75 decors, it is also customizable with a minimum order of 500 meters. 8605 may be fixed to the wall with adhesive (PP/96) or with nails; it does not absorb water, it does not contain formaldehyde, it is resistant to the impact, wear (AC3 certified), UV and products usually used to clean floors and walls. 8605, with these features, is perfect for the completion of glued or floating LVT.

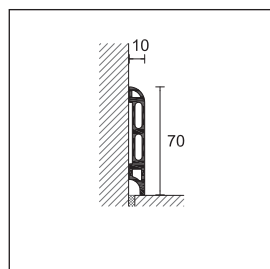

8605

PVC LINE

length = 250 cm - pack 20 pcs

FOAM PVC COVERED WITH FILM

H = 70 mm

ART.	decors ALCROM® PLUS		decors ALCROM® PLUS		decors ALCROM® PLUS	
	02	29000	78	29022	1045	29115
	08	29001	80	29023	1048	29116 *
	09	29002	81	29024	1051	29117
	10	29003	90	29025 *	1054	29118
	11	29004	92	29026	1057	29119
	12	29005	93	29027 *	1060	29120
	20	29006	94	29028 *	1063	29121
	25	29032	95	29029	1066	29122
	32	29007	white 96	29030	1069	29123
	34	29008	black 97	29031	1072	29124 *
	35	29009	1003	29101	1075	29125 *
8605	36	29010	1006	29102	1078	29126 *
	40	29011	1009	29103	1081	29127
	41	29012	1012	29104	1084	29128
	44	29013	1015	29105 *	1087	29129
	46	29014 *	1018	29106 *	1090	29130
	47	29033	1021	29107	1093	29131 *
	48	29015	1024	29108	1096	29132 *
	50	29016 *	1027	29109 *	1099	29133 *
	60	29017 *	1030	29110	1102	29134 *
	65	29018	1033	29111	1105	29135
	70	29019 *	1036	29112	1108	29136
	76	29020	1039	29113 *	1111	29137
	77	29021	1042	29114	1114	29138 *
euro/m						
			silver 98	29034		
8605		NEW	satin silver 99	29035		
		NEW	satin steel 100	29036		
euro/m						

MS POLYMER-BASED ADHESIVE FOR SKIRTING BOARDS

quantity 290 ml - pack 24 pcs

PP/96

78301

euro/pc

output 10/15 m for cartridge

Customized PDS decors on request, see page 220

* Out of production items, available till end of stock

For a single piece, see sales conditions on page 305



PVC Line 8612 is a foam PVC skirting board covered with Alcrom Plus film. 8612 is perfectly suitable for glued or floating LVT floors and can be fixed to the wall with adhesive (PP/96).

8612/10 foam PVC covered with Alcrom® Plus film - decor 96

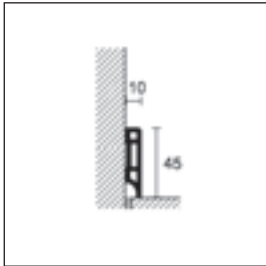

8612/10

PVC LINE

length 250 cm - pack 20 pcs

FOAM PVC COVERED WITH FILM

ART.	decor ALCROM® PLUS	
white 96		29970
<i>euro/m</i>		
8612/10 silver 98	NEW	29969
satin silver 99	NEW	29968
satin steel 100	NEW	29967
<i>euro/m</i>		

no partial packaging

decors Alcrom® Plus - available for skirting boards (art. 8605)

02	08	09	10	11	12	20	25
32	34	35	36	40	41	44	46
47	48	50	60	65	70	76	77
78	80	81	90	92	93	94	95
white 96	black 97	silver 98	satin silver 99	satin steel 100	1003	1006	1009
1012	1015	1018	1021	1024	1027	1030	1033
1036	1039	1042	1045	1048	1051	1054	1057
1060	1063	1066	1069	1072	1075	1078	1081
1084	1087	1090	1093	1096	1099	1102	1105
1108	1111	1114					

Profilpas Digital System

no limits to imagination



Profilpas gives the possibility to choose between over 400 standard decors Alcrom® Plus to combine the chosen profile or skirting board with the floor perfectly: indeed, a wide selection of wood, stone or concrete decors is available in our database to meet every need. Just consult our PDS bunch to discover the decor that best suits to your wish of combination.

But that's not all. The possibility of customization is really limitless with Profilpas. We just need to

receive a sample for creating any further decor, even a fantasy one!

This is possible thanks to Profilpas Digital System (PDS), the innovative digital printing technology of Profilpas to reproduce any decor on Alcrom Plus film and not to give limits to imagination! The whole production process is made inside our factory: from the scanner to the printing and the application of the film.

Please note: for customizations with decors that are not in our database, there is an extra of for decor.

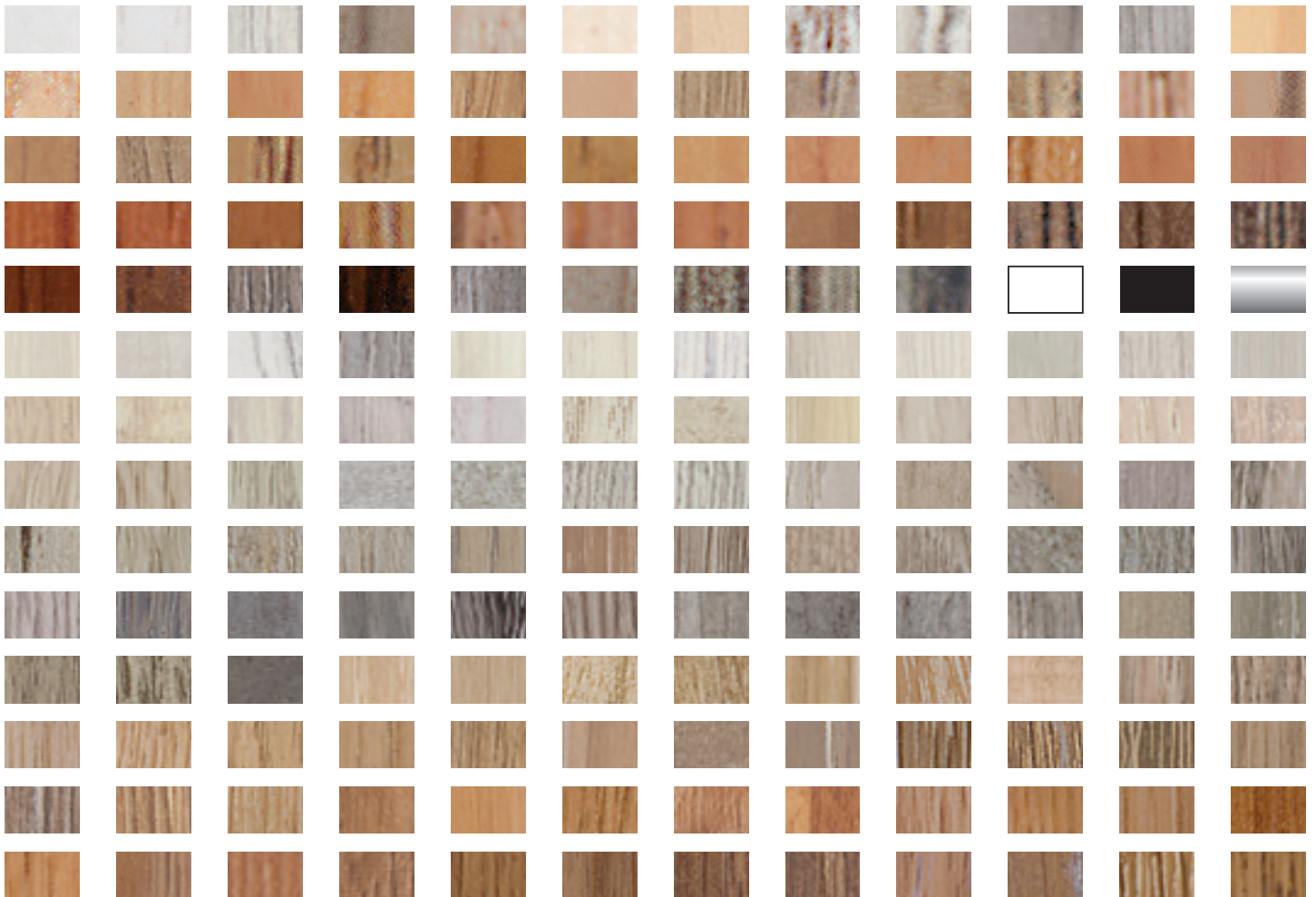



UNISYSTEM PLUS Z/1, C/7, S/9	min. 54 m
Quantity 20 pcs / 54 m = + €/m	Quantity 120 pcs / 324 m = + €/m
Quantity 40 pcs / 108 m = + €/m	Quantity 140 pcs / 378 m = + €/m
Quantity 60 pcs / 162 m = + €/m	Quantity 160 pcs / 432 m = + €/m
Quantity 80 pcs / 216 m = + €/m	Quantity 180 pcs / 486 m = + €/m
Quantity 100 pcs / 270 m = + €/m	Quantity 200 pcs / 540 m = + €/m
UNISYSTEM PLUS G/2 AND G/4	min. 540 m
PROFIX THIN Z/4, C/4 AND S/4	min. 540 m
PVC LINE 8608, 8605, 8612, 8613 AND 8614	min. 500 m

For the customization of other articles, please contact our Sales Department.
 Please note: for customizations with decors that are not in our database, there is an extra of for decor.







bendable profiles

Proflex line is a line of bendable profiles for laying ceramic tile floors, hardwood floors, carpet, wood, laminate, etc.. where it is necessary to follow the curvilinear shape of the floor. Through the use of Proflex Machine, these profiles are easily adaptable to the required curvature.





AIF/10 stainless steel AISI 304 DIN 14301

Proflex line is a line of bendable skirting boards and profiles for laying ceramic tile floors, hardwood floors, carpet, wood, laminate, etc.. where it is necessary to follow the curvilinear shape of the floor. Through the use of Proflex Machine, these profiles are easily adaptable to the required curvature.

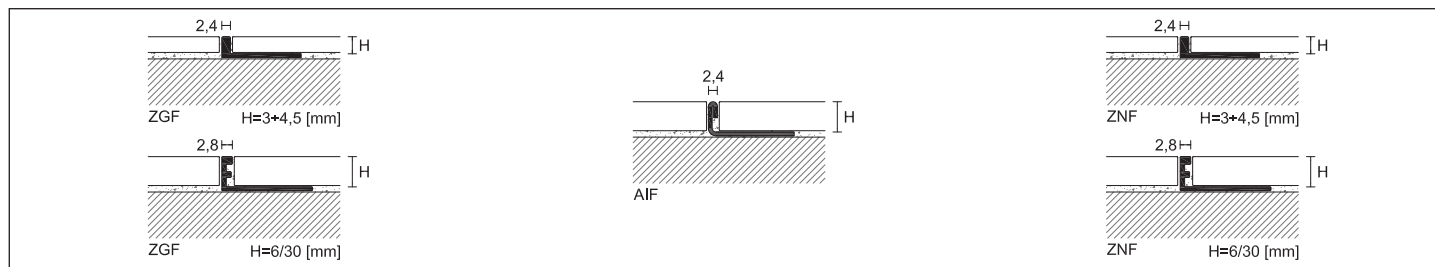

PROANGLE FLEX

length = 270 cm - pack 20 pcs

		H												
ART.	finishing	3	4,5	6	8	10	12,5	15	17,5	20	22,5	25	27,5	30
ALUMINIUM														
ZGF/	natural aluminium	88720	88721	88722	88723	88724	88725	88726	-	88728	88729	88730	-	-
	euro/m													
STAINLESS STEEL														
AIF/	stainless steel AISI 304 DIN 14301	-	-	91622	91623	91624	91625	-	-	-	-	-	-	-
	euro/m													
BRASS														
ZNF/	natural brass	88701	88702	88703	88704	88705	88706	88707 *	88708 *	88709 *	88710 *	88711 *	88712 *	88713 *
	euro/m													

pack of 10 pcs ZGF/ and ZNF/ from H 17 to 30 mm and AIF/ from H 6 to 12,5 mm

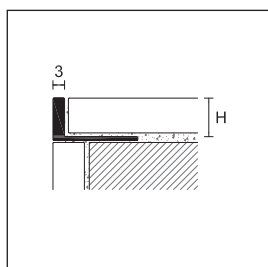

PROANGLE FLEX

length = 270 cm - pack 20 pcs

		H					
ART.	finishing	8	10	12,5	15	20	22,5
ALUMINIUM							
ZBGF/	natural aluminium	90011	90013	90015	90017	90019	90021
	euro/m						

individually packed

Complete the article code with H measure (for example ZGF/ for H=8 becomes ZGF/8) - * Out of production items, available till end of stock - For a single piece, see sales conditions on page 305



DAF/10 silver anodised aluminium

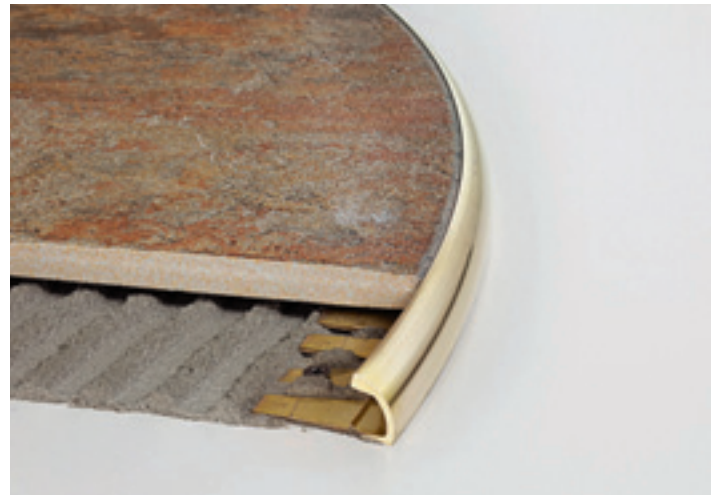

RNF/10 natural brass

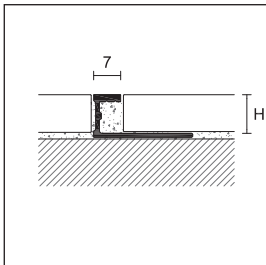

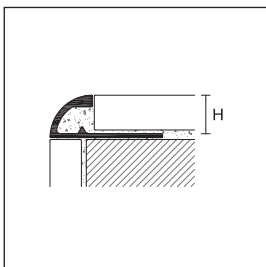

DAF/
DNF/



RAF/
RNF/

PRODECOR FLEX



length = 270 cm - pack 20 pcs

		H			
ART.	finishing	8	10	12,5	
ALUMINIUM					
DAF/	silver anodised		95950	95951	95952
	<i>euro/m</i>				
BRASS					
DNF/	natural brass		95630	95631	95632
	<i>euro/m</i>				

individually packed - art. DNF/12,5 pack 10 pcs

PROTRIM FLEX

length = 270 cm - pack 10 pcs

		H		
ART.	finishing	8	10	
ALUMINIUM				
RAF/	silver anodised		92082	92084
	<i>euro/m</i>			
BRASS				
RNF/	natural brass		92476 *	92478 *
	<i>euro/m</i>			

individually packed

Complete the article code with the height H
(for example DAF/ with H=8 becomes DAF/8)

* Out of production items, available till end of stock

For a single piece, see sales conditions on page 305



99/T/14 silver anodised aluminium

Joint Flex is a line of bendable profiles for the separation, protection and decoration of ceramic tile floors, marble, wood and laminate. They are easy to apply thanks to the arrow shape that permits an excellent anchorage with sealings or adhesives.

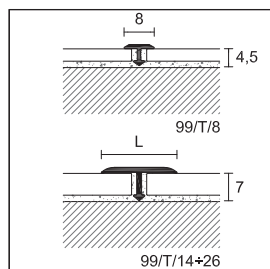

99/T/
399/T/
399/TC/

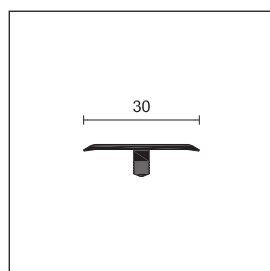

Z3/30/SF

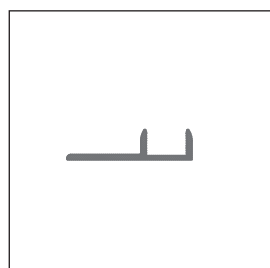

TPUF/

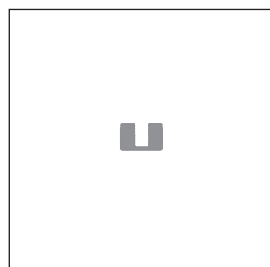

TU/6

PROJOINT T - SEPARATION JOINTS

pack	50 pcs	50 pcs	30 pcs	20 pcs
length cm	270			
width	8	14	20	26
ART. finishing				

ALUMINIUM

99/T/	silver anodised		75075	75080	63600	75082
	gold anodised		-	75083	75084	75085
	<i>euro/m</i>					
	titanium anodised		-	75099	-	-
	<i>euro/m</i>		-	-	-	-

COLOUR-COATED ALUMINIUM

99/T/	anthracite grey RAL 7016		-	75091	-	-
	<i>euro/m</i>		-	-	-	-
length 270 cm - pack	50 pcs	20 pcs	20 pcs	20 pcs		

BRASS

399/T/	polished		75070	75087	75090	75088
	<i>euro/m</i>					
length 270 cm - pack	30 pcs	30 pcs	-	10 pcs		
399/TC/	chromium plated		75071	75086	-	75089
	<i>euro/m</i>			-		

individually packed

UNISYSTEM/UNISYSTEM PLUS

length = 270 cm - pack	20 pcs		
ART. finishing			
ANODISED ALUMINIUM			
399/TC/	silver		63700
	gold		63702
	gold sand		63704
	<i>euro/m</i>		

individually packed

UNISYSTEM PLUS BASE FOR (Z3/30/SF)

floor thickness from / to mm	6,5/10	12,6/15,5		
length = 270 cm - pack	20 pcs	H		
ART. finishing	6	13		
TPUF/	aluminium (+15 clips include)		67439	67459
	<i>euro/m</i>			

individually packed

SPARE CLIPS

pack	150 pcs	H
ART. finishing	6	
TU/6		68812/150
	<i>euro/pack</i>	

Complete the article code with the width (for example 99/T for L=8 becomes 99/T/8)

• Out of production items, available till end of stock

For a single piece, see sales conditions on page 305

Profiles Z3/30/SF, please order the base separately.



RCF/ anodised aluminium silver

RCF/ is a line of bendable border profiles, available in silver anodised aluminium, for the floating installation of wooden and laminate floors.

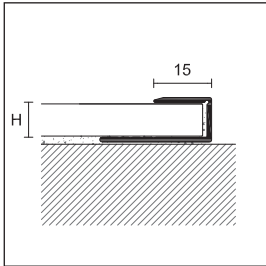

RCF/

TERMINAL FLEX

length = 270 cm - pack 10 pcs

		H				
ART.	finishing	7	9	11	15	22,5
ALUMINIUM						
RCF/	silver anodised	67710	67712	67714	67718	67722

euro/m

individually packed

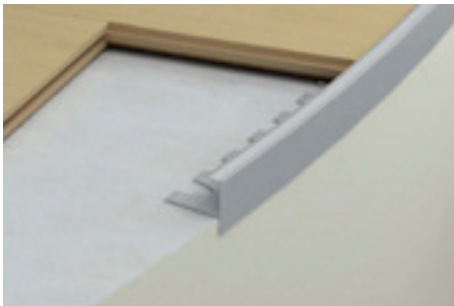

GF/710 silver anodised aluminium

Pronivel PLAF/ and Prostep GF/ are bendable profiles for floors of different level and for stairs or platform with a curvilinear shape. The kit to bend these profiles should be bought separately.

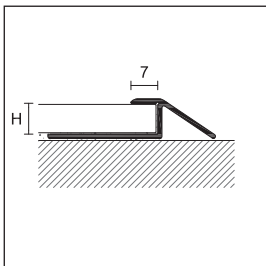

PLAF/

PRONIVEL FLEX

length = 270 cm - pack 10 pcs

		H	
ART.	finishing	8	10
ALUMINIUM			
PLAF/	silver anodised	93190	93192

euro/m

individually packed

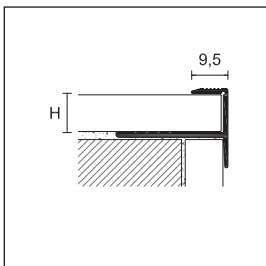

GF/

PROSTEP FLEX

length = 270 cm - pack 10 pcs

		H	
ART.	finishing	10	15
ALUMINIUM			
GF/	silver anodised	67569	67350
	gold anodised	67570 *	67352 *

euro/m

individually packed

Complete the article code with H measure
(for example PLAF/ for H=8 becomes PLAF/8)

Complete the article code with H measure
(for example RCF/ for H=9 becomes RCF/9)

* Out of production items, available till end of stock





For a single piece, see sales conditions on page 305



90FX/8 silver anodised aluminium

Metal Line 90 and 90FX are two bendable skirting boards in aluminium that, thanks to the curved part, create an elegant junction between the wall and the floor.

METAL LINE 90FX

length = 200 cm - pack 10 pcs		H cm			
ART.	finishing	4	6	8	
ALUMINIUM					
90FX/	silver anodised		78570 *	78571 *	78572 *
	<i>euro/m</i>				
METAL INSIDE CORNER - pack 4 pcs					
90/ MI	silver		78630	78650	78670
	<i>euro/pc</i>				
METAL OUTSIDE CORNER - pack 4 pcs					
90/ ME	silver		78631	78651	78671
	<i>euro/pc</i>				
METAL JUNCTION - pack 4 pcs					
90/ MG	silver		78632	78652	78672
	<i>euro/pc</i>				
RIGHT-LEFT END CAPS METAL - 4 couples pack					
90/ MP	silver		78633	78653	78673
	<i>euro/pc</i>				

Metal Line can be also curved in the other finishes (see page 231) by using Proflex Machine + wheels kit for Metal Line.

Complete the article code with H measure
(for example 90FX/ for H=4 becomes 90FX/4)

* Out of production items, available till end of stock

For a single piece, see sales conditions on page 305

Proflex machine is a machine designed and built to model the profiles with curvilinear shape of the proflex line produced by Profilpas. The machine contains a proper kit and more kits are available in case you need to bend the PLAF or 90/FX / series metal line.

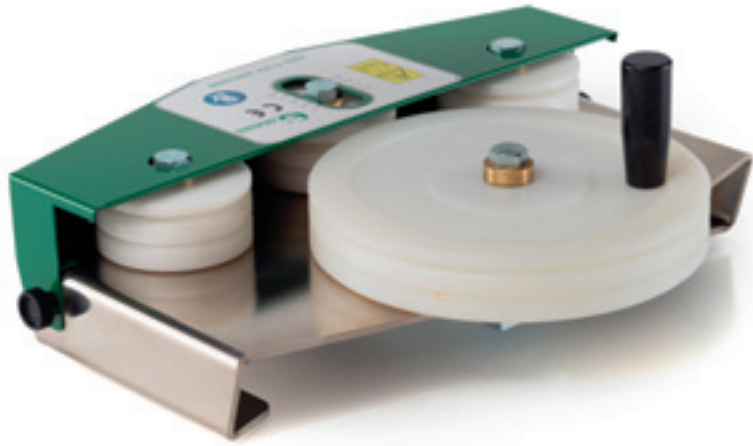

PROFLEX MACHINE - hand machine to bend proflex line profiles

PROFLEX MACHINE

ART.	description	
proflex	hand machine to bend profiles inside and outside <i>euro/pc</i>	30022
30046	wheels kit with perforated side on the outside for PLAF <i>euro/pc</i>	30046
30049	wheels kit with perforated side on the inside for PLAF <i>euro/pc</i>	30049
30052	wheels kit for metal line flex 90/ <i>euro/pc</i>	30052



kit 30046



kit 30049



kit 30052

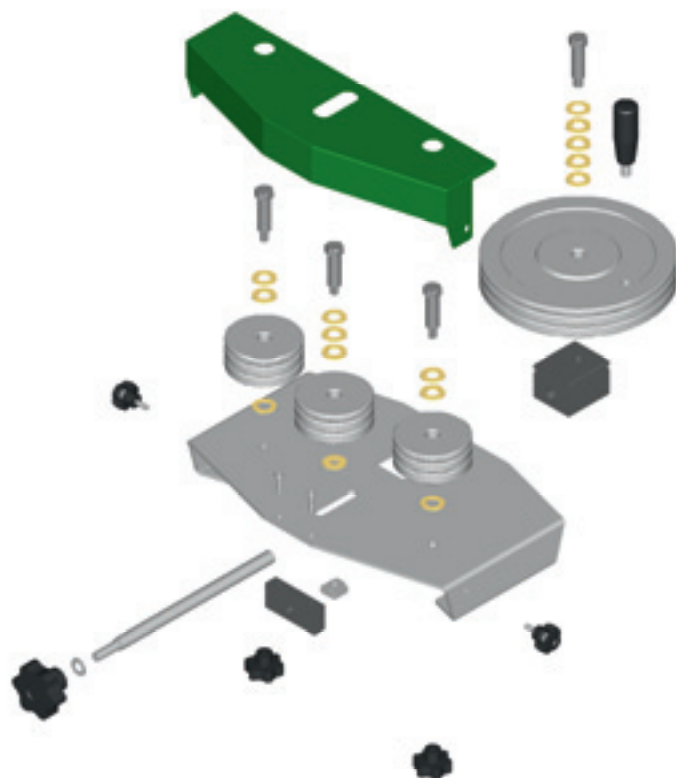





metal line skirting board

To choose Metal Line means giving importance to details because they are the ones who make the difference. Metal Line is distinguished by its versatility and functionality, but also for its inspiration to contemporary design. It is an innovative line, rich of solutions with a wide variety of combinations and colours capable of satisfying every housing need, from small and large gathering places. Stainless steel and aluminium, materials that give shape, colour and size to the space, minimalist signs that follow the flow of everyday life. Metal Line can provide a continuum of profiles that integrate perfectly into environments and different styles, enhancing their aesthetic and architectural appeal. Metal Line becomes a trend line, thanks to Profilpas research on materials and shapes and to the attention of the company to the world of furniture and design.



skirting board

metal line

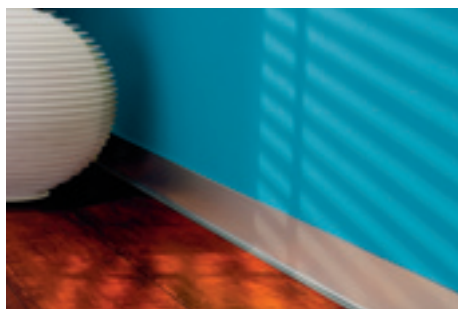

90/10 silver anodised aluminium

Metal Line 90 skirting boards, in anodised aluminium and in different finishes and heights, create an elegant junction between the wall and the floor. Thanks to the curved part, they perfectly hide the perimetral expansion gap of a floating floor. The Silent version is also available: it allows to increase the house's comfort with a decrease of the impact noise transmission until 6dB A (equivalent to 67%) (certified by University of Ferrara - Engineering department). 90/6 Silent is also easy to install as it is only available in the self-adhesive version for a quicker application. Metal accessories for inside corners, outside corners, junctions and end caps are available for both models.

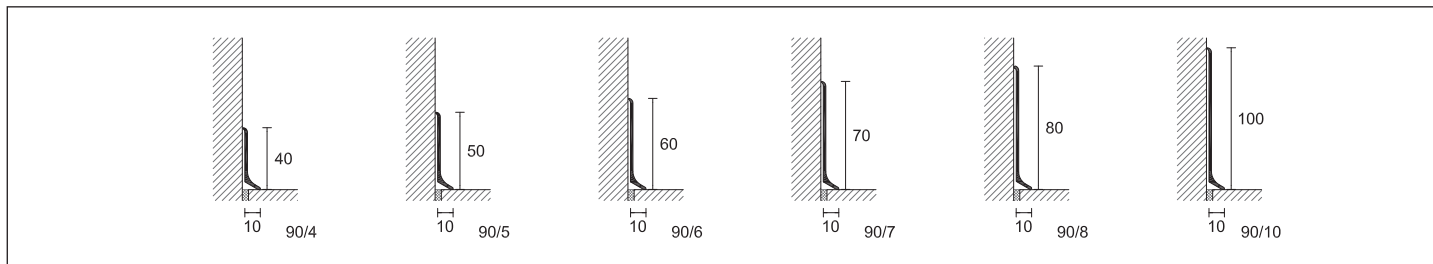

METAL LINE 90

length = 200 cm - pack 25 pcs

		H cm						
ART.	finishing	4	5	6	7	8	10	
ALUMINIUM								
	silver anodised		78080	78084	78100	78138	78130	78137
	colour-coated polished white RAL 9010		-	-	78112	-	-	-
	colour-coated matt white RAL 9010		-	-	78110	-	-	-
	euro/m							
90/ SF	titanium anodised		-	-	78103	-	-	-
	euro/m							
	colour-coated anthracite grey		-	-	78118	-	-	-
	colour-coated ancient grey		-	-	78119	-	-	-
	euro/m							
90/ A	self-adhesive silver anodised		-	-	78106	-	78136	-
	euro/m							
90/ TSF	bright polished titanium		78083	78087	78111	-	78141	-
90/ SSF	bright satin silver		78082	78086	78105	-	78133	-
	bright satin gold		-	-	78107	-	78135	-
	euro/m							
90/ TMSF	bright satin titanium		78088	-	78102	-	78134	-
	euro/m							

individually packed

90/4SF, 90/5SF, 90/6SF and 90/8SF in silver anodised aluminium, available also in length 400 cm

Metal Line 90 can be curved by using Proflex Machine + wheels kit for Metal Line 90 (see page 228).

the self-adhesive version in height 4, 5, 7, 8 and 10 is available on request, with a minimum order of 200 meters and a surcharge of € /m

RAL 9003, RAL 7038, RAL 8019, RAL 9006, RAL 9007 colour-coated aluminium skirting boards are available on request, with a minimum order of 300 meters. For other colours, please contact our sales department.

Complete the article code with H measure (for example 90/SF for H=4 becomes 90/4SF)

For a single piece, see sales conditions on page 305

METAL LINE 90 SILENT

length = 200 cm - pack 25 pcs

		H cm	
ART.	finishing	6	
ALUMINIUM			
90/6SA	self-adhesive silver anodised		78148
	euro/m		

individually packed



90/6 + 90/6/MI + 90/6/ME silver anodised aluminium

Metal Line 90, new metal accessories proposed in different finishes and heights complete the range. The modern aesthetic appearance and the ease of assembly contribute to a pleasant final effect.

METAL INSIDE CORNER

pack 4 pcs		H cm					
ART.	finishing	4	5	6	7	8	10
	silver	78630	78640	78650	78660	78670	78680
	<i>euro/pc</i>						
90/ MI	titanium	-	-	78654	-	-	-
	polished white RAL 9010	-	-	78664	-	-	-
	matt white RAL 9010	-	-	78674	-	-	-
	anthracite grey	-	-	78684	-	-	-
	ancient grey	-	-	78694	-	-	-
	polished titanium	78634	78644	78704	-	78708	-
	satin silver	78718	78719	78720	-	78722	-
	satin gold	-	-	78724	-	78744	-
	satin titanium	78714	-	78734	-	78754	-
		<i>euro/pc</i>					

no partial packaging

METAL OUTSIDE CORNER

pack 4 pcs		H cm					
ART.	finishing	4	5	6	7	8	10
	silver	78631	78641	78651	78661	78671	78681
	<i>euro/pc</i>						
90/ ME	titanium	-	-	78655	-	-	-
	polished white RAL 9010	-	-	78665	-	-	-
	matt white RAL 9010	-	-	78675	-	-	-
	anthracite grey	-	-	78685	-	-	-
	ancient grey	-	-	78695	-	-	-
	polished titanium	78635	78645	78705	-	78709	-
	satin silver	78728	78729	78730	-	78732	-
	satin gold	-	-	78725	-	78745	-
	satin titanium	78715	-	78735	-	78755	-
		<i>euro/pc</i>					

no partial packaging

METAL JUNCTION

pack 4 pcs		H cm					
ART.	finishing	4	5	6	7	8	10
	silver	78632	78642	78652	78662	78672	78682
	<i>euro/pc</i>						
90/ MG	titanium	-	-	78656	-	-	-
	polished white RAL 9010	-	-	78666	-	-	-
	matt white RAL 9010	-	-	78676	-	-	-
	anthracite grey	-	-	78686	-	-	-
	ancient grey	-	-	78696	-	-	-
	polished titanium	78636	78646	78706	-	78710	-
	satin silver	78738	78739	78740	-	78742	-
	satin gold	-	-	78726	-	78746	-
	satin titanium	78716	-	78736	-	78756	-
		<i>euro/pc</i>					

no partial packaging

METAL RH-LH END CAPS

4 couples pack		H cm					
ART.	finishing	4	5	6	7	8	10
	silver	78633	78643	78653	78663	78673	78683
	<i>euro/couple</i>						
90/ MP	titanium	-	-	78657	-	-	-
	polished white RAL 9010	-	-	78667	-	-	-
	matt white RAL 9010	-	-	78677	-	-	-
	anthracite grey	-	-	78687	-	-	-
	ancient grey	-	-	78697	-	-	-
	polished titanium	78637	78647	78707	-	78711	-
	satin silver	78748	78749	78750	-	78752	-
	satin gold	-	-	78727	-	78747	-
	satin titanium	78717	-	78737	-	78757	-
		<i>euro/couple</i>					

no partial packaging



On request, corners in pack of 1 pc in blister + € (in this case 90/6/MI code 78654 becomes 78654/B) - Complete the article code with the height H (for example 90/ MI with H=4 becomes 90/4MI) - For a single piece, see sales conditions on page 305



790/6 satin stainless steel AISI 304 DIN 1.4301

Metal Line 790 profiles are made in stainless steel and they are available in different finishes and heights, in line with the modern minimalist trends of furnished design. With them it is possible to create an elegant and perfect junction between the wall and the floor. Thanks to the coved shape the profiles provide an excellent coverage along the perimeter area in order to hide the perimeter expansion of a floating floor. Easy and quick installation on the wall by the use of suitable adhesives.

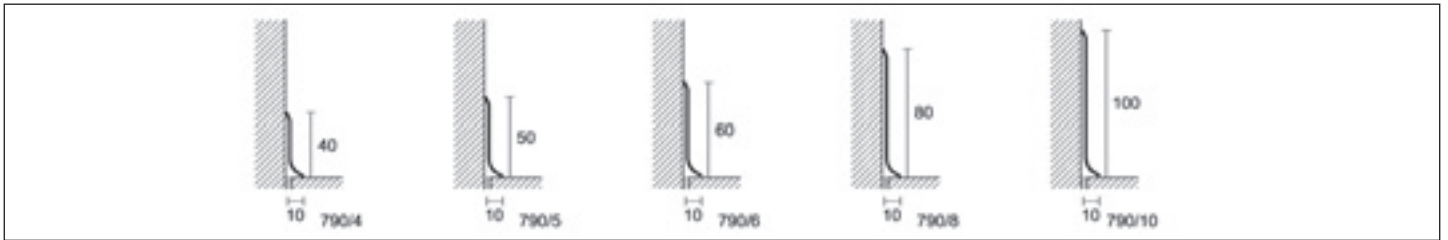

790/MI
790/MIS



790/ME
790/MES

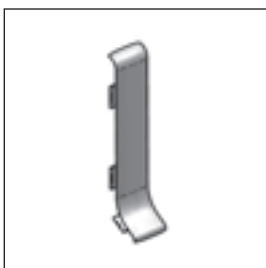

790/MG
790/MGS

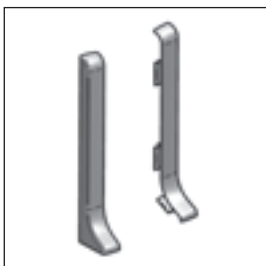

790/MP
790/MPS

On request, corners in pack of 1 pc in blister + € (in this case 790/6/MI code 78762 becomes 78762/B)
The self-adhesive version is available in every height on request, with a minimum order of 200 meters and a surcharge of €/m
Complete the article code with H measure (for example 790/SF for H=4 becomes 790/4SF)

For a single piece, see sales conditions on page 305

METAL LINE 790

length = 270 cm - pack 10 pcs

		H cm					
ART.	finishing	4	5	6	8	10	
STAINLESS STEEL							
790/ SF	polished stainless steel AISI 304 DIN 14301 <i>euro/m</i>		78120	78108	78129	78132	78139
	satin stainless steel AISI 304 DIN 1.4301 <i>euro/m</i>		78128	78109	78126	78127	78140

individually packed - art. 790/10 SF pack 5 pcs

INSIDE CORNER IN METAL

pack 4 pcs

		H cm					
ART.	finishing	4	5	6	8	10	
790/ MI	finishing polished <i>euro/pc</i>		78760	78761	78762	78763	78764
790/ MIS	finishing satin <i>euro/pc</i>		78780	78781	78782	78783	78784

no partial packaging

OUTSIDE CORNER IN METALLO

pack 4 pcs

		H cm					
ART.	finishing	4	5	6	8	10	
790/ ME	finishing polished <i>euro/pc</i>		78765	78766	78767	78768	78769
790/ MES	finishing satin <i>euro/pc</i>		78785	78786	78787	78788	78789

no partial packaging

JUNCTION IN METALLO

pack 4 pcs

		H cm					
ART.	finishing	4	5	6	8	10	
790/ MG	finishing polished <i>euro/pc</i>		78770	78771	78772	78773	78774
790/ MGS	finishing satin <i>euro/pc</i>		78790	78791	78792	78793	78794

no partial packaging

RIGHT-LEFT END CAPS IN METAL

pack 4 pcs

		H cm					
ART.	finishing	4	5	6	8	10	
790/ MP	finishing polished <i>euro/couple</i>		78775	78776	78777	78778	78779
790/ MPS	finishing satin <i>euro/couple</i>		78795	78796	78797	78798	78799

no partial packaging

skirting board

metal line

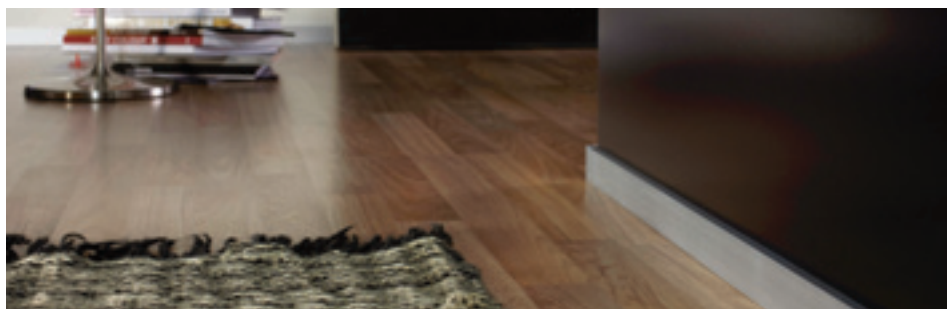

89/4 silver anodised aluminium



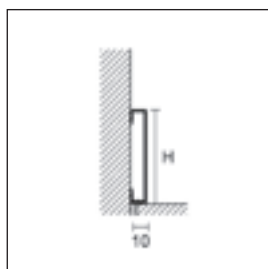



Metal Line 89 are profiles made in aluminium and available in different finishes. They are skirting boards with an essential and square shape; height 4, 6 and 8 cm, they delineate the space with care and elegance. Fixed on the wall using suitable adhesives, they guarantee a perfect coverage of the perimeter area giving a decorative motif, in order to satisfy the need of hiding the perimeter spaces expansion of floating floors.



89/

METAL LINE 89







length = 200 cm - pack 25 pcs

		H cm			
ART.	finishing	4	6	8	
ALUMINIUM					
	silver anodised		78378	78478	78487
	<i>euro/m</i>				
	titanium anodised		78521	78522	-
	<i>euro/m</i>				
89/	colour-coated matt white RAL 9010		78517	78518	-
	<i>euro/m</i>				
	colour-coated ancient grey		78515	78485	-
	colour-coated rust		78516	-	-
	<i>euro/m</i>				
89/ TM	bright satin titanium		78388	78480	-
	<i>euro/m</i>				

individually packed

INSIDE/OUTSIDE CORNER - RIGHT/LEFT END CAP

pack 4 pcs

		H cm			
ART.	finishing	4	6	8	
ALUMINIUM					
	silver anodised		78505	78506	78527
	<i>euro/pc</i>				
	titanium anodised		78523	78524	-
	<i>euro/pc</i>				
89/ EI	colour-coated matt white RAL 9010		78519	78520	-
	<i>euro/pc</i>				
	colour-coated ancient grey		78512	78513	-
	colour-coated rust		78514	-	-
	<i>euro/pc</i>				
89/ TMEI	bright satin titanium		78509	78510	-
	<i>euro/pc</i>				

no partial packaging

Ancient grey, RAL 9003, RAL 7038, RAL 8019, RAL 9006, RAL 9007 colour-coated aluminium skirting boards are available on request, with a minimum order of 300 meters. For other colours, please contact our sales department.

Complete the article code with H measure
(for example 89/ for H=4 becomes 89/4)

For a single piece, see sales conditions on page 305



89/4 ancient grey colour-coated aluminium + 89/4EI



89/4 bright satin titanium aluminium



89/613 silver anodised aluminium

Metal Line 89/613 in anodised aluminium or white colour-coated is a skirting board with a square shape, 13 mm thick, it is ideal to guarantee a perfect covering of the perimetral area. This thickness satisfies the need to hide the perimetral expansion gaps especially of floating floors.

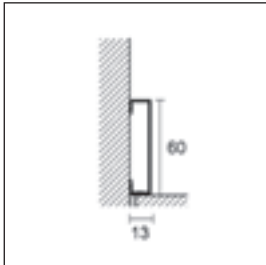

89/613

METAL LINE 89/613

length = 200 cm - pack 25 pcs		H cm
ART.	finishing	6
ALUMINIUM		
	silver anodised	78486
	<i>euro/m</i>	
89/613	colour-coated matt white RAL 9010	78488
	<i>euro/m</i>	

individually packed

INSIDE/OUTSIDE CORNER - RIGHT/LEFT END CAP

pack 4 pcs		H cm
ART.	finishing	6
ALUMINIUM		
	silver anodised	78525
	<i>euro/pc</i>	
89/613 EI	colour-coated matt white RAL 9010	78526
	<i>euro/pc</i>	

no partial packaging

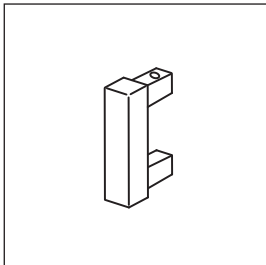

89/613 EI

Metal Line 91 in anodised aluminium creates a refined junction between the wall and the floor. The lower part is very curved and protruding in order to guarantee a perfect coverage of the perimetral expansion gap, thus satisfying the need of hiding perimetral gaps of floating floors with substantial expansion or defects of laying.

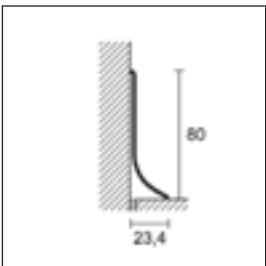

91/8SF

METAL LINE 91

length 200 cm - pack 20 pcs		H cm
ART.	finishing	8
ALUMINIUM		
	silver anodised	78600
	<i>euro/m</i>	
91/8SF		

individually packed

skirting board

metal line



Metal Line 87/6 and 88/6 are skirting boards flush with the wall for plaster and plasterboard walls, composed of two separate elements. The base element made of natural aluminium is integrated with a wood or aluminium insert available in different finishes. Once installed, the obtained effect is that of a skirting board recessed into the wall which highlights the perimeter of the room without limiting the boundaries. There are two different phases of installation: the base element must be installed when the room is still in its rough state, and the chosen insert must be put after the laying of the floor.

87/6 and 88/6 natural aluminium + 88/16L/A aluminium insert for LED light

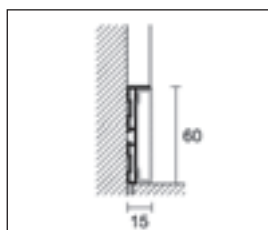

87/6 + 88/16SF
aluminium insert

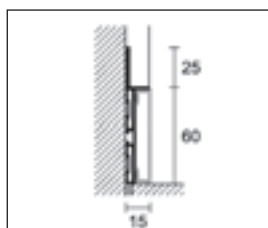

88/6 + 88/16SF
aluminium insert

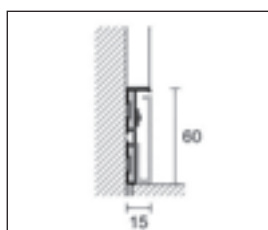

87/6 + 88/16L/A
aluminium insert for
LED light

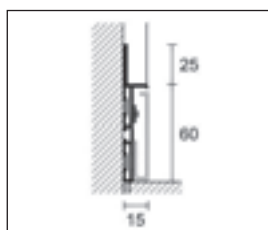

88/6 + 88/16L/A
aluminium insert for
LED light

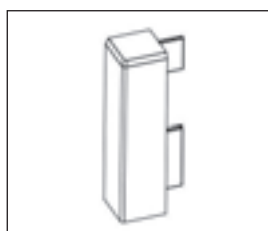

88/6E

METAL LINE 87 E 88

length = 200 cm - pack 20 pcs		H cm
ART.	finishing	6
ALUMINIUM		
87/6	natural aluminium (drilled)	78338
	euro/m	
88/6	natural aluminium (drilled)	78310
	euro/m	

individually packed

ALUMINIUM INSERT

length = 200 cm - pack 20 pcs		H cm
ART.	finishing	6
88/16SF	silver anodised	78563
	matt white RAL 9010 colour-coated	78558
	euro/m	

individually packed

ALUMINIUM INSERT FOR LED LIGHT

length = 200 cm - pack 20 pcs		H cm
88/16L/A	silver anodised	78559
	matt white RAL 9010 colour-coated	78560
	euro/m	

adhesive - individually packed
foa electrical components, see page 59

METAL OUTSIDE CORNER

pack 4 pcs		H cm
ART.	finishing	6
88/6E	silver	78561
	matt white RAL 9010 colour-coated	78562
	euro/pc	

no partial packaging

For a single piece, see sales conditions on page 305

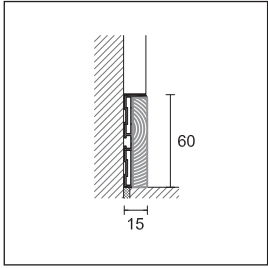



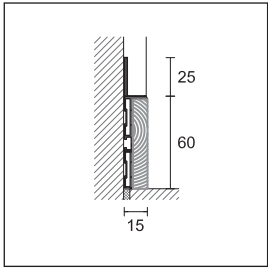





87/6 + 88/16SF
solid wood insert



88/16SF
solid wood insert

SOLID WOOD INSERT

length = 200 cm

	solid wood insert natural oak		78550 *
	solid wood insert country oak		78551 *
	solid wood insert antique oak		78552 *
	euro/m		
	solid wood insert walnut		78553 *
	euro/m		
88/16SF	solid wood insert mahogany		78554 *
	euro/m		
	solid wood insert cherry		78555 *
	euro/m		
	solid wood insert wengè		78556 *
	euro/m		
	solid wood insert natural beech		78557 *
	euro/m		

individually packed

* Out of production items, available till end of stock



88/6 natural aluminium + 88/16SF matt white aluminium insert



87/6 + 88/16SF silver anodised aluminium insert

skirting board

metal line



100/70 silver anodised aluminium

Metal Line 100 is an anodized aluminium baseboard available in two heights and suitable for application of plasterboard, directly into the wall. The profile is easy to apply through the use of appropriate adhesives.

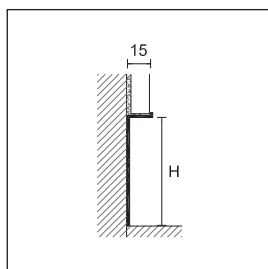

100/

METAL LINE 100

length = 200 cm - pack 20 pcs		H mm	
ART.	finishing	40	70
ALUMINIUM			
100/	silver anodised	78277	78279
<i>euro/m</i>			
individually packed			



101/74 silver anodised aluminium

Metal Line 101, ideal for plaster and made of anodized aluminium, is suitable for application directly on the rough wall. The profile is applied using special adhesives, before making the plastering of the wall.

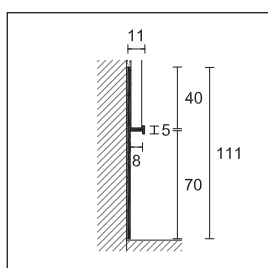

101/74

METAL LINE 101

length = 200 cm - pack 20 pcs		H mm	
ART.	finishing	70	
ALUMINIUM			
101/74	silver anodised	78281	
<i>euro/m</i>			
individually packed			

MS POLYMER-BASED ADHESIVE FOR SKIRTING BOARDS

pack 24 pcs - quantity 290 ml	
ART.	
PP/96	78301
<i>euro/pc</i>	
output 10/15 m for cartridge	

SILVER PVC GASKET

length = 200 cm - pack 20 pcs (for all models in stainless steel and aluminium)	
ART.	
GM/90	78024 *
<i>euro/m</i>	
no partial packaging	

Ancient grey, RAL 9003, RAL 7038, RAL 8019, RAL 9006, RAL 9007 colour-coated aluminium skirting boards are available on request, with a minimum order of 300 meters. For other colours, please contact our sales department.

* Out of production items, available till end of stock

For a single piece, see sales conditions on page 305



92/7 silver anodised aluminium + S/95 aluminium support

Metal Line 92 and 93 in aluminium have a simple and minimal design to connect the wall to the floor. They have a simple and rapid installation system of interlocking natural aluminium or PVC supports, fixed to the wall using screws and dowels.

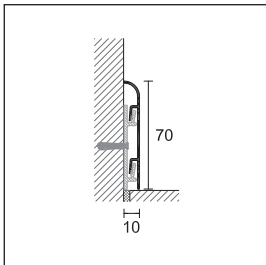

92/7

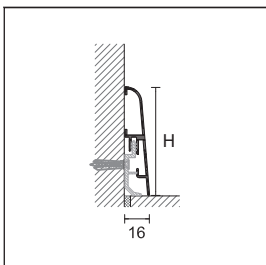

93/

METAL LINE 92

length = 200 cm + 3 supports - pack 20 pcs H cm

ART. finishing 7

ALUMINIUM

92/7	silver anodised		78490
	euro/m		

individually packed

ALUMINIUM SUPPORT

pack 100 pcs

S/95 78295

euro/pc

METAL LINE 93

length = 200 cm + 5 supports - pack 20 pcs H cm

ART. finishing 7 9

ALUMINIUM

93/	silver anodised		78495	78496
	euro/m			

individually packed

FIXING CLIPS

pack 100 pcs

8608/C 29751

euro/pack

Ancient grey, RAL 9003, RAL 7038, RAL 8019, RAL 9006, RAL 9007 colour-coated aluminium skirting boards are available on request, with a minimum order of 300 meters. For other colours, please contact our sales department.

For a single piece, see sales conditions on page 305



93/7 silver anodised aluminium + 8608/C fixing clips

skirting board metal line



95/7 silver anodised aluminium

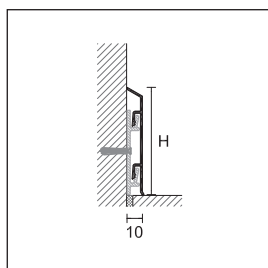

95/

Metal Line 95 profile, made of aluminium and available in two different heights, are unique in their simplicity, they can transform the wall floor junction in an imperceptible sign; they are practical and functional in the protection of cables (telephone, computer, TV, etc.). They have a simple and rapid installation system of interlocking natural aluminium supports, attached to the wall using screws and dowels for an easy access for maintenance to any service cable.

METAL LINE 95

pack 25 pcs		length	H cm	
ART.	finishing		7	10

ALUMINIUM

95/ SF	silver anodised		200 cm + 3 supports	78160	78175
			400 cm + 6 supports	78161	78176

euro/m

95/ TSF	bright polished titanium		200 cm + 3 supports	78165 *	-

euro/m

95/ TMSF	bright satin titanium		200 cm + 3 supports	78162 *	-

euro/m

individually packed - length 400 cm pack 10 pcs

ALUMINIUM SUPPORT

pack 100 pcs	
--------------	--

S/95	78295
------	-------

euro/pc

no partial packaging

INSIDE CORNER IN POLYPROPYLENE

pack 4 pcs		H cm	
------------	--	------	--

ART.	finishing	7	10
-------------	------------------	----------	-----------

95/ I	silver anodised		78201	78206

euro/pc

95/ TI	bright polished titanium		78276 *	-

95/ TMI	bright satin titanium		78500 *	-

euro/pc

no partial packaging

OUTSIDE CORNER IN POLYPROPYLENE

pack 4 pcs		H cm	
------------	--	------	--

ART.	finishing	7	10
-------------	------------------	----------	-----------

95/ E	silver anodised		78200	78205

euro/pc

95/ TE	bright polished titanium		78274 *	-

95/ TME	bright satin titanium		78501 *	-

euro/pc

no partial packaging

JUNCTION IN POLYPROPYLENE

pack 4 pcs		H cm	
------------	--	------	--

ART.	finishing	7	10
-------------	------------------	----------	-----------

95/ G	silver anodised		78202	78207

euro/pc

95/ TG	bright polished titanium		78275 *	-

95/ TMG	bright satin titanium		78502 *	-

euro/pc

no partial packaging

RIGHT/LEFT END CAPS IN POLYPROPYLENE

4 couples pack		H cm	
----------------	--	------	--

ART.	finishing	7	10
-------------	------------------	----------	-----------

95/ P	silver anodised		78203	78208

euro/couple

95/ TP	bright polished titanium		78282 *	-

95/ TMP	bright satin titanium		78503 *	-

euro/couple

no partial packaging

Ancient grey, RAL 9003, RAL 7038, RAL 8019, RAL 9006, RAL 9007 colour-coated aluminium skirting boards are available on request, with a minimum order of 300 meters. For other colours, please contact our sales department.

Complete the article code with the height H (for example 95/ SF with H=7 becomes 95/7SF)

For a single piece, see sales conditions on page 305



96/7SF silver anodised aluminium

Metal Line 96, in aluminium, is a skirting board with a special design, with soft lines to break the rigidity of the union between wall and floor, allowing the housing of any cables (telephone, computer, TV, etc.). They have a simple and rapid installation system of interlocking natural aluminium supports, attached to the wall using screws and dowels for an easy access for maintenance to any service cables.

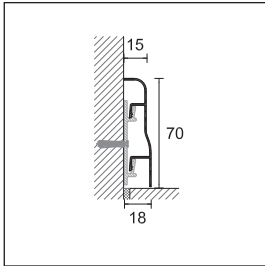

96/7SF



96/7 silver anodised aluminium
+ S/95 aluminium support

METAL LINE 96

pack 20 pcs			H cm
ART.	finishing	length	7
ALUMINIUM			
96/7SF	silver anodised	200 cm + 3 supports	78025 *
		400 cm + 6 supports	78026 *
<i>euro/m</i>			

individually packed - length 400 cm pack 10 pcs

ALUMINIUM SUPPORT

pack 100 pcs	
S/95	78295
<i>euro/pc</i>	

no partial packaging

INSIDE CORNER IN POLYPROPYLENE

pack 4 pcs			H cm
ART.	finishing		7
96/7I	silver anodised		78216 *
<i>euro/pc</i>			

no partial packaging

OUTSIDE CORNER IN POLYPROPYLENE

pack 4 pcs			H cm
ART.	finishing		7
96/7E	silver anodised		78215 *
<i>euro/pc</i>			

no partial packaging

JUNCTION IN POLYPROPYLENE

pack 4 pcs			H cm
ART.	finishing		7
96/7G	silver anodised		78217 *
<i>euro/pc</i>			

no partial packaging

RIGHT/LEFT END CAPS IN POLYPROPYLENE

4 couples pack			H cm
ART.	finishing		7
96/7P	silver anodised		78218 *
<i>euro/couple</i>			

no partial packaging

Ancient grey, RAL 9003, RAL 7038, RAL 8019, RAL 9006, RAL 9007 colour-coated aluminium skirting boards are available on request, with a minimum order of 300 meters. For other colours, please contact our sales department.

* Out of production items, available till end of stock

For a single piece, see sales conditions on page 305

skirting board metal line

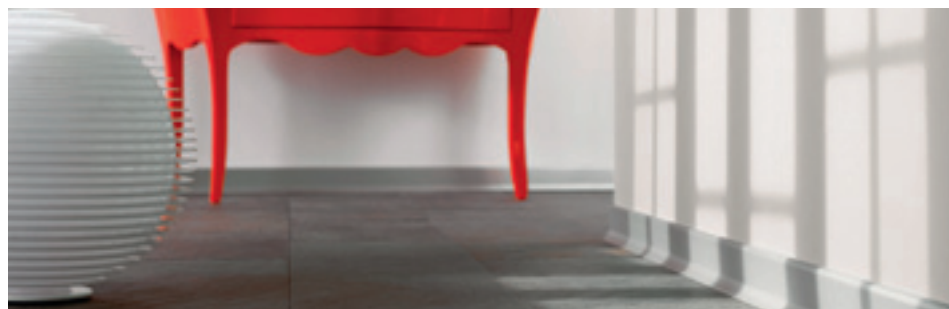

98/7SF silver anodised aluminium

Metal Line 98, made in aluminium allows the housing of any cable (telephone, computer, TV, etc.) permitting their hide and protection. They have a soft line that gives elegance. A simple and functional system of interlocking installation in natural aluminium, attached to the wall using screws and dowels, provides easy accessibility to cable, for any maintenance.

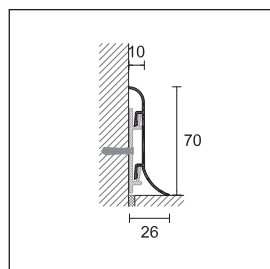

98/7SF



98/7SF silver anodised aluminium
+ S/95 aluminium support

METAL LINE 98

pack 20 pcs			H cm
ART.	finishing	length	7
ALUMINIUM			
98/7SF	silver anodised	200 cm + 3 supports	78040
		400 cm + 6 supports	78041
euro/m			

individually packed - length 400 cm pack 10 pcs

ALUMINIUM SUPPORT

pack 100 pcs	
S/95	78295
euro/pc	

no partial packaging

INSIDE CORNER IN POLYPROPYLENE

pack 4 pcs			H cm
ART.	finishing		7
98/7I	silver anodised		78221
euro/pc			

no partial packaging

OUTSIDE CORNER IN POLYPROPYLENE

pack 4 pcs			H cm
ART.	finishing		7
98/7E	silver anodised		78220
euro/pc			

no partial packaging

JUNCTION IN POLYPROPYLENE

pack 4 pcs			H cm
ART.	finishing		7
98/7G	silver anodised		78222
euro/pc			

no partial packaging

RIGHT/LEFT END CAPS IN POLYPROPYLENE

4 couples pack			H cm
ART.	finishing		7
98/7P	silver anodised		78223
euro/couple			

no partial packaging

Ancient grey, RAL 9003, RAL 7038, RAL 8019, RAL 9006, RAL 9007 colour-coated aluminium skirting boards are available on request, with a minimum order of 300 meters. For other colours, please contact our sales department.

For a single piece, see sales conditions on page 305



97/4TMSF bright satin gold aluminium

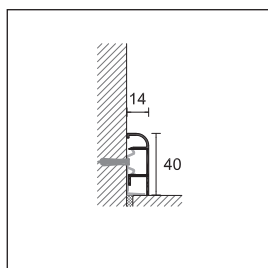

97/



97/4SF silver anodised aluminium
+ 8602/C fixing clip

Metal Line 97/4, made in aluminium allows the housing of any cable (telephone, computer, TV, etc.) permitting their hide and protection. It can be used in any environment thanks to its discreet presence. A simple and functional system of harmonic stainless steel clips, fixed to the wall using screws and dowels, provides easy accessibility to cable, for any maintenance.

METAL LINE 97

length = 200 cm - pack 25 pcs H cm

ART. finishing 4

ALUMINIUM

97/4SF silver anodised 78000
+ 5 clips
euro/m

97/4TMSF bright satin titanium 78015 *
+ 5 clips
euro/m

individually packed

FIXING CLIPS

10 blister packs/ 20 pcs/blister

8602/C 29750

euro/blister

no partial packaging

INSIDE CORNER IN POLYPROPYLENE

pack 4 pcs H cm

ART. finishing 4

97/4I silver anodised 78002
euro/pc

97/4TMI bright satin titanium 78380 *
euro/pc

no partial packaging

OUTSIDE CORNER IN POLYPROPYLENE

pack 4 pcs H cm

ART. finishing 4

97/4E silver anodised 78001
euro/pc

97/4TME bright satin titanium 78381 *
euro/pc

no partial packaging

JUNCTION IN POLYPROPYLENE

pack 4 pcs H cm

ART. finishing 4

97/4G silver anodised 78003
euro/pc

97/4TMG bright satin titanium 78382 *
euro/pc

no partial packaging

RIGHT/LEFT END CAPS IN POLYPROPYLENE

4 couples pack H cm

ART. finishing 4

97/4P silver anodised 78004
euro/couple

97/4TMP bright satin titanium 78383 *
euro/couple

no partial packaging

Ancient grey, RAL 9003, RAL 7038, RAL 8019, RAL 9006, RAL 9007 colour-coated aluminium skirting boards are available on request, with a minimum order of 300 meters. For other colours, please contact our sales department.

* Out of production items, available till end of stock

For a single piece, see sales conditions on page 305

skirting board

metal line

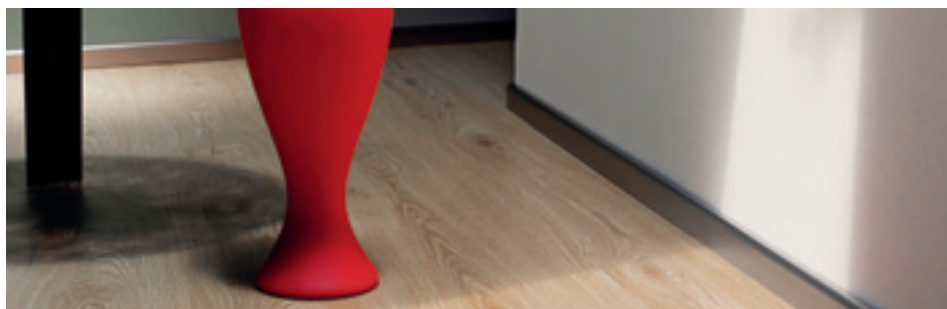

97/7SF silver anodised aluminium

Metal Line 97/7 in aluminium has a simple and minimal design to connect wall to floor. It has a simple and rapid installation system of interlocking natural aluminium supports, fixed to the wall using screws and dowels, providing easy accessibility to cable, for any maintenance.

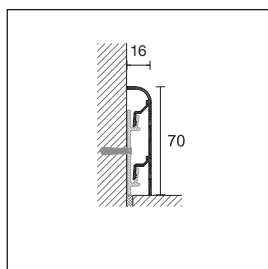

97/7SF



96/7 silver anodised aluminium
+ S/95 aluminium support

METAL LINE 97

length = 200 cm - pack 20 pcs H cm

ART. finishing **7**

ALUMINIUM

97/7SF+ silver anodised  78005

euro/m

individually packed

ALUMINIUM SUPPORT

pack 100 pcs

S/95 78295

euro/pc

no partial packaging

INSIDE CORNER IN POLYPROPYLENE

pack 4 pcs H cm

ART. finishing **7**

97/7I silver anodised  78157

euro/pc

no partial packaging

OUTSIDE CORNER IN POLYPROPYLENE

pack 4 pcs H cm

ART. finishing **7**

97/7E silver anodised  78156

euro/pc

no partial packaging

JUNCTION IN POLYPROPYLENE

pack 4 pcs H cm

ART. finishing **7**

97/7G silver anodised  78158

euro/pc

no partial packaging

RIGHT/LEFT END CAPS IN POLYPROPYLENE

4 couples pack H cm

ART. finishing **7**

97/7P silver anodised  78159

euro/couple

no partial packaging

Ancient grey, RAL 9003, RAL 7038, RAL 8019, RAL 9006, RAL 9007 colour-coated aluminium skirting boards are available on request, with a minimum order of 300 meters. For other colours, please contact our sales department.

For a single piece, see sales conditions on page 305

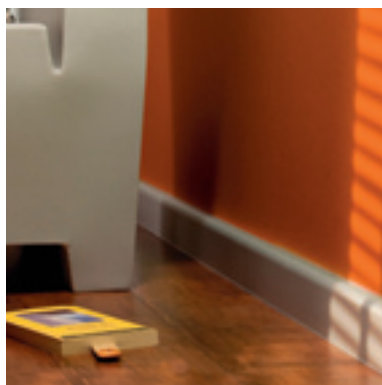

97/8SF silver anodised aluminium

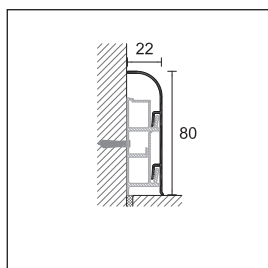

97/8SF



97/8SF silver anodised aluminium
+ 97/8CB white pvc trunking

Metal Line 97/8, in aluminium, outlines perfectly the junction between the wall and the floor. Designed for housing cables, thanks to the use of a PVC trunking, that fixed to the wall through screws and dowels it is also useful as support of the skirting board. It is 'particularly suitable in case of renovations, avoiding making new tracks for the passage of trunking for cables. It is easy and fast to install, even only using natural aluminium supports, fixed to the wall with screws and dowels, when the PVC trunking is not used. Simple accessibility to cable, for any maintenance.

METAL LINE 97

pack 20 pcs			H cm
ART.	finishing	length	8
ALUMINIUM			
97/8SF	silver anodised	200 cm + 3 supports	78010
		400 cm + 6 supports	78011

euro/m

individually packed - length 400 cm pack 10 pcs

WHITE PVC TRUNKING

length 200 cm - pack 20 pcs		
97/8CB		78290

euro/m

no partial packaging

ALUMINIUM SUPPORT

pack 100 pcs		
S/97		78299

euro/pc

no partial packaging

INSIDE CORNER IN POLYPROPYLENE

pack 4 pcs			H cm
ART.	finishing		8
97/8I	silver anodised		78211

euro/pc

no partial packaging

OUTSIDE CORNER IN POLYPROPYLENE

pack 4 pcs			H cm
ART.	finishing		8
97/8E	silver anodised		78210

euro/pc

no partial packaging

JUNCTION IN POLYPROPYLENE

pack 4 pcs			H cm
ART.	finishing		8
97/8G	silver anodised		78212

euro/pc

no partial packaging

RIGHT/LEFT END CAPS IN POLYPROPYLENE

4 couples pack			H cm
ART.	finishing		8
97/8P	silver anodised		78213

euro/couple

no partial packaging

Ancient grey, RAL 9003, RAL 7038, RAL 8019, RAL 9006, RAL 9007 colour-coated aluminium skirting boards are available on request, with a minimum order of 300 meters. For other colours, please contact our sales department.

For a single piece, see sales conditions on page 305





PVC line skirting board

A line of PVC skirting board that meets any technical and colour combination. Suitable for both the professional and the DIY, it can be personalized with the models 8605, 8608, 8612, 8613 and 8614.





8605 foam PVC covered with Alcrom® Plus film

PVC Line 8605 is a PVC foam skirting board, foiled with PDS film. Available in 75 decors, it is also customizable with a minimum order of 500 meters. 8605 may be fixed to the wall with adhesive (PP/96) or with nails; it does not absorb water, it does not contain formaldehyde, it is resistant to the impact, to the wear (certificate AC3), to UV rays and to cleaning products for floors and walls.

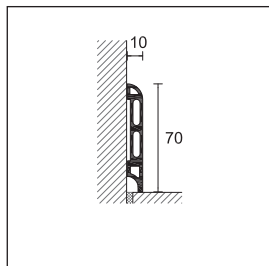

8605



8605 satin silver 99

PVC LINE

length = 250 cm - pack 20 pcs

FOAM PVC COVERED WITH FILM

H = 70 mm

ART.	decors ALCROM® PLUS		decors ALCROM® PLUS		decors ALCROM® PLUS		
	02	29000	78	29022	1045	29115	
	08	29001	80	29023	1048	29116 *	
	09	29002	81	29024	1051	29117	
	10	29003	90	29025 *	1054	29118	
	11	29004	92	29026	1057	29119	
	12	29005	93	29027 *	1060	29120	
	20	29006	94	29028 *	1063	29121	
	25	29032	95	29029	1066	29122	
	32	29007	white 96	29030	1069	29123	
	34	29008	black 97	29031	1072	29124 *	
	35	29009	1003	29101	1075	29125 *	
8605	36	29010	1006	29102	1078	29126 *	
	40	29011	1009	29103	1081	29127	
	41	29012	1012	29104	1084	29128	
	44	29013	1015	29105 *	1087	29129	
	46	29014 *	1018	29106 *	1090	29130	
	47	29033	1021	29107	1093	29131 *	
	48	29015	1024	29108	1096	29132 *	
	50	29016 *	1027	29109 *	1099	29133 *	
	60	29017 *	1030	29110	1102	29134 *	
	65	29018	1033	29111	1105	29135	
	70	29019 *	1036	29112	1108	29136	
	76	29020	1039	29113 *	1111	29137	
	77	29021	1042	29114	1114	29138 *	
	euro/m						
				silver 98	29034		
8605			NEW satin silver 99	29035			
			NEW satin steel 100	29036			
euro/m							

no partial packaging

MS polymer-based adhesive for skirting boards see page 286

Customized PDS decors on request for 8605 with a minimum order of 500 meters.

For customizations with decors that are not in our database, there is an extra of € for decor.

* Out of production items, available till end of stock

For a single piece, see sales conditions on page 305

decors Alcrom® Plus - available for skirting boards (art. 8605)

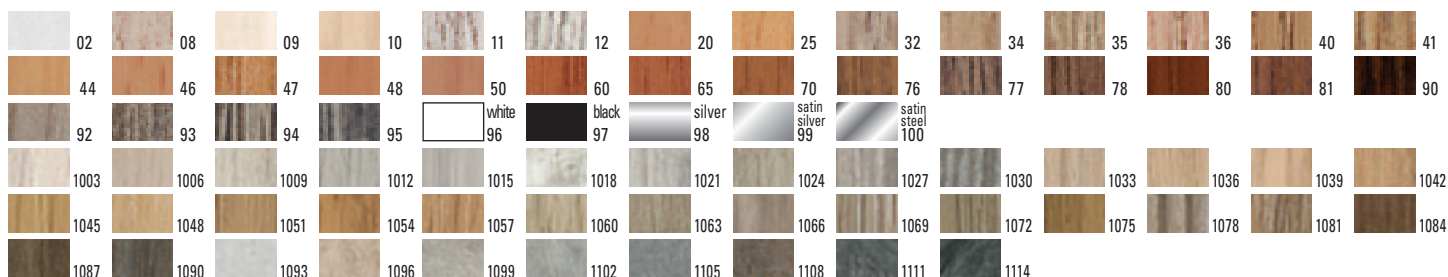

In the present catalogue, due to the printing, the colour shades can be slightly different from the real ones.



8608 foam PVC covered with Alcrom® Plus film + 8608/C

PVC Line 8608 is a PVC foam skirting board, foiled with Alcrom® Plus film. Available in 45 decors, it is also customizable with a minimum order of 500 meters. 8608 may be fixed to the wall with its fixing clip, adhesive (PP/96) or with nails; it does not absorb water, it does not contain formaldehyde, it is resistant to the impact, to the wear (certificate AC3), to UV rays and to cleaning products for floors and walls.

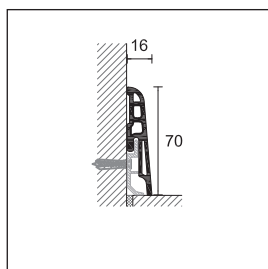

8608

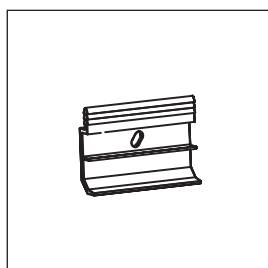

8608/C

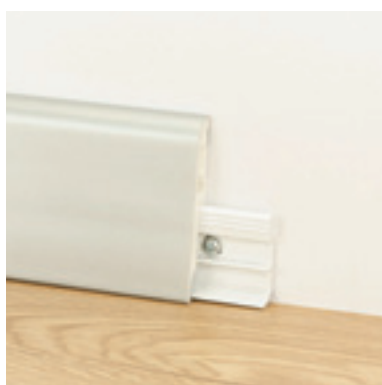

8608 silver 98

PVC LINE

length = 250 cm - pack 20 pcs

FOAM PVC COVERED WITH FILM

H = 70 mm

ART.	decors ALCROM® PLUS		decors ALCROM® PLUS		decors ALCROM® PLUS	
	02	29040	34	29048	76	29060
	05	29075	35	29049	77	29061
	08	29041	36	29050	78	29062
	09	29042	39	29080	80	29063
	10	29043	40	29051	81	29064
	11	29044	41	29052	89	29081
	12	29045	44	29053	90	29065 *
8608	14	29076	46	29054 *	91	29082
	19	29077	47	29073	92	29066
	20	29046	48	29055 *	93	29067 *
	25	29072	50	29056 *	94	29068 *
	26	29078	60	29057 *	95	29069
	31	29079	65	29058	white 96	29070
	32	29047	70	29059 *	black 97	29071
euro/m						
			silver 98	29074		
8608		NEW	satin silver 99	29083		
		NEW	satin steel 100	29084		
euro/m						

no partial packaging

FIXING CLIPS FOR ART. 8608

pack of 100 pcs

8608/C	29751
euro/pack	

In the present catalogue, due to the printing, the colour shades can be slightly different from the real ones.

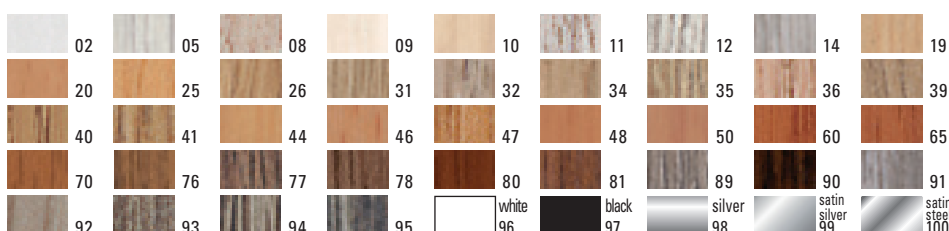

MS polymer-based adhesive for skirting boards see page 286

* Out of production items, available till end of stock

Customized PDS decors on request for 8608 with a minimum order of 500 meters.

For customizations with decors that are not in our database, there is an extra of € for decor.

For a single piece, see sales conditions on page 305



8613 foam PVC covered with Alcrom® Plus film - decor 98

PVC Line 8613 is a foam PVC skirting board covered with Alcrom® Plus film, suitable for wooden floors. It can be fixed to the wall with adhesive (PP/96) or fixing clip 8608/C.

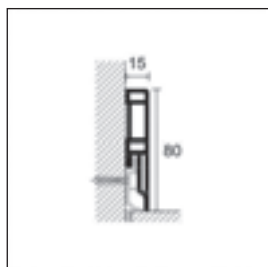

8613

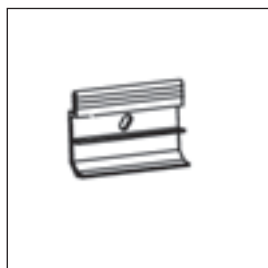

8608/C

PVC LINE

length = 250 cm - pack 20 pcs

FOAM PVC COVERED WITH FILM

H = 80 mm

ART.	decor ALCROM® PLUS		decor ALCROM® PLUS	
	05	30060 NEW	1201	30077 NEW
	08	30061 NEW	1202	30078 NEW
	12	30062 NEW	1203	30079 NEW
	13	30063 NEW	1204	30080 NEW
	14	30064 NEW	1205	30081 NEW
	19	30065 NEW	1206	30082 NEW
	26	30066 NEW	1207	30083 NEW
	31	30094 NEW	1208	30084 NEW
	32	30067 NEW	1209	30085 NEW
8613	36	30068 NEW	1210	30086 NEW
	39	30069 NEW	1211	30087 NEW
	40	30070 NEW	1212	30088 NEW
	41	30071 NEW	1213	30089 NEW
	77	30072 NEW	1214	30090 NEW
	89	30073 NEW	1215	30091 NEW
	91	30074 NEW	1216	30092 NEW
	93	30075 NEW	1217	30093 NEW
	96 white	29971		
	580	30076 NEW		
euro/m				
	silver 98	NEW 29973		
8613	satin silver 99	NEW 29974		
	satin steel 100	NEW 29975		



8613 satin steel 100

FIXING CLIPS FOR ART. 8613

pack of 100 pcs

8608/C

euro/pack

29751

no partial packaging

In the present catalogue, due to the printing, the colour shades can be slightly different from the real ones.

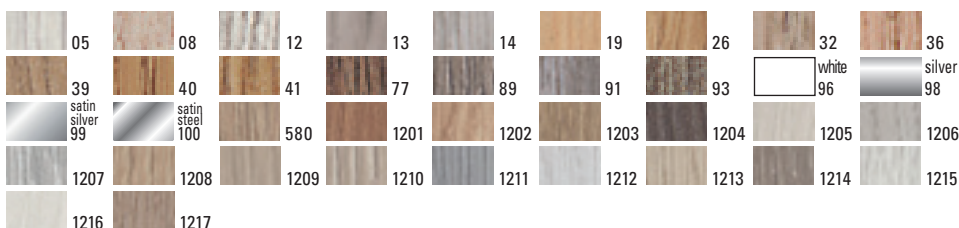

Customized PDS decors on request for 8613 with a minimum order of 500 meters.

For customizations with decors that are not in our database, there is an extra of € for decor.

For a single piece, see sales conditions on page 305 251



8612/10 foam PVC covered with Alcrom® Plus film - decor 96

PVC Line 8612 is a foam PVC skirting board covered with Alcrom® Plus film, suitable for both ceramic and LVT floors. It can be fixed to the wall with adhesive (PP/96).

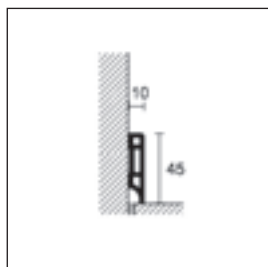

8612/10

PVC LINE

length 250 cm - pack 20 pcs

FOAM PVC COVERED WITH FILM

ART.	decors	decor ALCROM® PLUS	
	white 96		29970
	<i>euro/m</i>		
8612/10	silver 98		29969
	satin silver 99		29968
	satin steel 100		29967
	<i>euro/m</i>		

**NEW
NEW
NEW**

no partial packaging



8614 foam PVC covered with Alcrom® Plus film - decor 96

PVC Line 8614 is a foam PVC skirting board covered with white Alcrom® Plus film, suitable in case of refurbishment if you want to cover the old skirting boards that are still fixed to the wall. It can be fixed to the old skirting board with adhesive (PP/96).

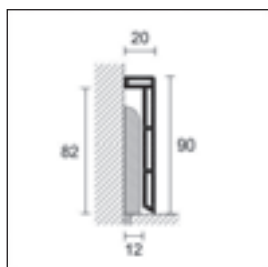

8614

PVC LINE

length = 250 cm - pack 20 pcs

H cm

FOAM PVC COVERED WITH FILM

9

ART.	decors		
8614	96		29972
	<i>euro/m</i>		

no partial packaging

Customized PDS decors on request for 8612/10 and 8614 with a minimum order of 500 meters.

For customizations with decors that are not in our database, there is an extra of € for decor.

For a single piece, see sales conditions on page 305

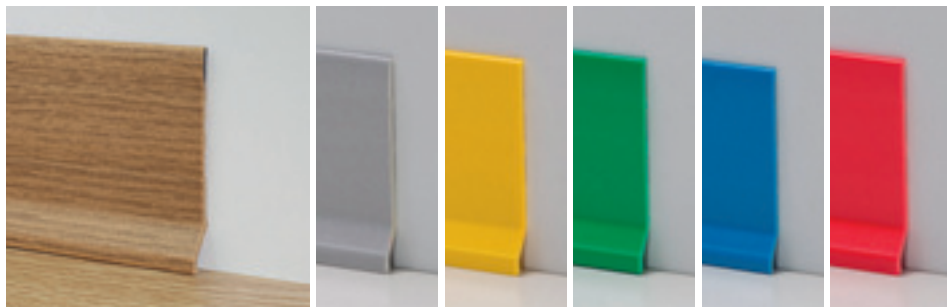

8600 foam PVC decor 582

PVC Line 8600, 8610 and 8611 a line of PVC foam skirting boards of edge protection and impact resistant. It is particularly suitable for DIY installation, thanks to the speed and simplicity of application. They are available in different colours and are fixed with adhesive (PP/96).

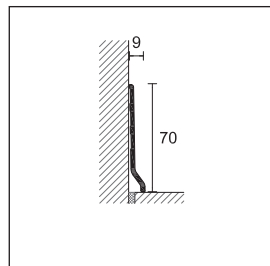

8600

PVC LINE

length 200 cm - pack 20/100 pcs

FOAM PVC

H = 70 mm

ART.	decors		decors		decors		decors	
8600	518	29762	536	29782	yellow 561	29802	grey 559	29800
	520	29764	540	29784	green 562	29804		
	524	29766	542	29786	light blue 563	29801		
	525	29768	544	29788	red 564	29803		
	528	29770	545	29790				
	530	29772	white 555	29792				
	531	29774	light grey 556	29794				
	532	29776	black 557	29796				
	533	29778	anthracite grey 558	29798				
	534	29780						

pack 20 pcs

euro/m

pack 100 pcs

euro/m

no partial packaging

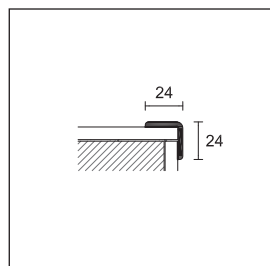

8610

PVC LINE

length 300 cm - pack 20/50 pcs

FOAM PVC

ART.	decors		decors		decors	
8610	518	29810	536	29830	561	29848
	520	29812	540	29832	562	29850
	524	29814	542	29834	563	29847
	525	29816	544	29836	564	29849
	528	29818	545	29838		
	530	29820	555	29840		
	531	29822	556	29842		
	532	29824	557	29844		
	533	29826 *	558	29846		
	534	29828				

pack 20 pcs

euro/m

pack 50 pcs

euro/m

no partial packaging

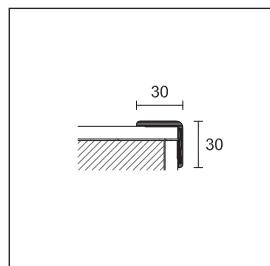

8611

PVC LINE

length 300 cm - pack 20/50 pcs

FOAM PVC

ART.	decors		decors		decors	
8611	518	29910	555	29940	561	29946
	532	29924	556	29942	562	29948
	542	29934	557	29944	563	29945
	545	29938			564	29947

pack 20 pcs

euro/m

pack 50 pcs

euro/m

no partial packaging

MS POLYMER-BASED ADHESIVE FOR SKIRTING BOARDS

quantity 290 ml - pack 24 pcs

PP/96

78301

euro/pc

output 10/15 m for cartridge

To order the pack of 100 pcs mark /100 after the article code (for example 29778 becomes 29778/100)

* Out of production items, available till end of stock

For a single piece, see sales conditions on page 305

In the present catalogue, due to the printing, the colour shades can be slightly different from the real ones.

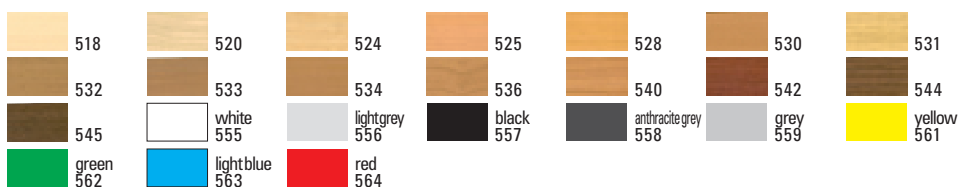



8598 Foam PVC decor 545

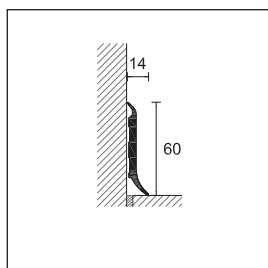

8596

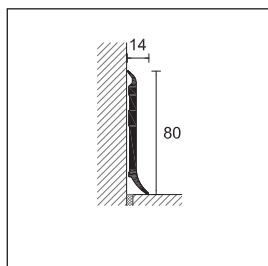

8598

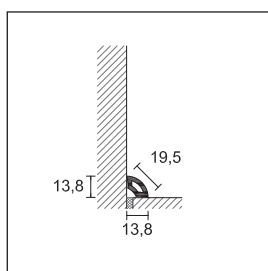

8580

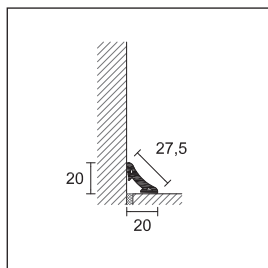

8582

PVC Line 8596, 8598 are a line of PVC foam skirting impact resistant. The shape and the lay on the wall, in soft material, allow a perfect adhesion even to substrates that are not perfectly planar, maintaining speed and simplicity of application. They are available in different colours and they are fixed with adhesive (PP/96).

PVC LINE

length = 250 cm - pack 40 pcs

FOAM PVC

H = 60 mm

ART.	decors		decors		decors	
8596	518	30800	531	30812	542	30824
	520	30802 *	532	30814	544	30826 *
	524	30804	533	30816	545	30828
	525	30806	534	30818 *	white 555	30830
	528	30808	536	30820	light grey 556	30832
	530	30810	540	30822	black 557	30834

euro/m

no partial packaging

PVC LINE

length = 250 cm - pack 40 pcs

FOAM PVC

H = 80 mm

ART.	decors	
8598	white 555	30880
	light grey 556	30882
	black 557	30884

euro/m

no partial packaging

PVC LINE

length = 250 cm - pack 80 pcs

FOAM PVC

ART.	decors		decors	
8580	532	30764	white 555	30780
	542	30774	light grey 556	30782
	545	30778	black 557	30784

euro/m

no partial packaging

PVC LINE

length = 250 cm - pack 60 pcs

FOAM PVC

ART.	decors		decors	
8582	532	30714	white 555	30730
	542	30724	light grey 556	30732
	545	30728	black 557	30734

euro/m

no partial packaging

In the present catalogue, due to the printing, the colour shades can be slightly different from the real ones.

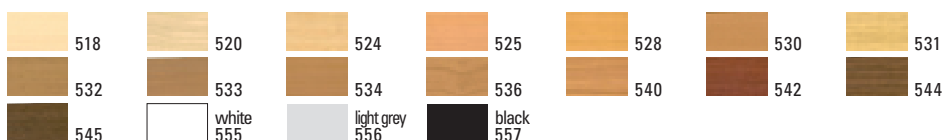

* Out of production items, available till end of stock

For a single piece, see sales conditions on page 305



8602 Foam PVC

PVC Line 8602 is a PVC foam skirting board, 48mm high impact resistant. It is particularly suitable for DIY installation, thanks to the speed and easiness of application. It is available in different colours and it is installed with a simple interlocking system with harmonic stainless steel clips. In addition to their decorative function, it allows to hide the expansion gap perimeter of floating wood and laminate floors.

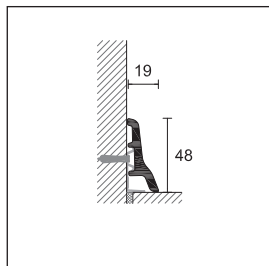

8602

PVC LINE

length 250 cm - pack 40 pcs

FOAM PVC

H = 48 mm

ART. decors

	white 555	29530
8602	light grey 556	29532
	black 557	29534

euro/m

no partial packaging

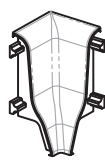

8602/I

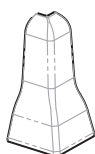

8602/E



8602/G



8602/P

INSIDE CORNER

pack 10 pcs

POLYPROPYLENE

H = 48 mm

ART. decors

	white 555	29578
8602/I	light grey 556	29580
	black 557	29582

euro/pc

no partial packaging

OUTSIDE CORNER

pack 10 pcs

POLYPROPYLENE

H = 48 mm

ART. decors

	white 555	29628
8602/E	light grey 556	29630
	black 557	29632

euro/pc

no partial packaging

JUNCTION

pack 10 pcs

POLYPROPYLENE

H = 48 mm

ART. decors

	white 555	29678
8602/G	light grey 556	29680
	black 557	29682

euro/pc

no partial packaging

RIGHT/LEFT END CAPS

pack 10 pcs

POLYPROPYLENE

H = 48 mm

ART. decors

	white 555	29728
8602/P dx/sx	light grey 556	29730
	black 557	29732

euro/pc

no partial packaging

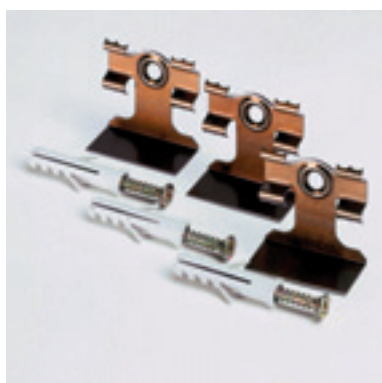

8602/C fixing clips

FIXING CLIPS

10 blister packs/ 20 pcs/blister

8602/C	29750
---------------	-------

euro/blister





8603 Foam PVC decor 555

PVC Line 8603 is a foam PVC skirting board, 70 mm high and impact resistant. It is particularly suitable for DIY installation, thanks to the speed and easiness of application. It is available in different colours and it can be installed with a simple interlocking system with harmonic stainless steel clips. In addition to its decorative function, it allows to hide the expansion gap perimeter of floating wood and laminate floors.

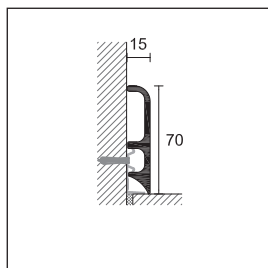

8603

PVC LINE

length 250 cm - pack 40 pcs

FOAM PVC

H = 70 mm

ART. decors

	532	30144
	542	30154
	545	30158
8603	white 555	30160
	light grey 556	30162
	black 557	30164

euro/m

no partial packaging

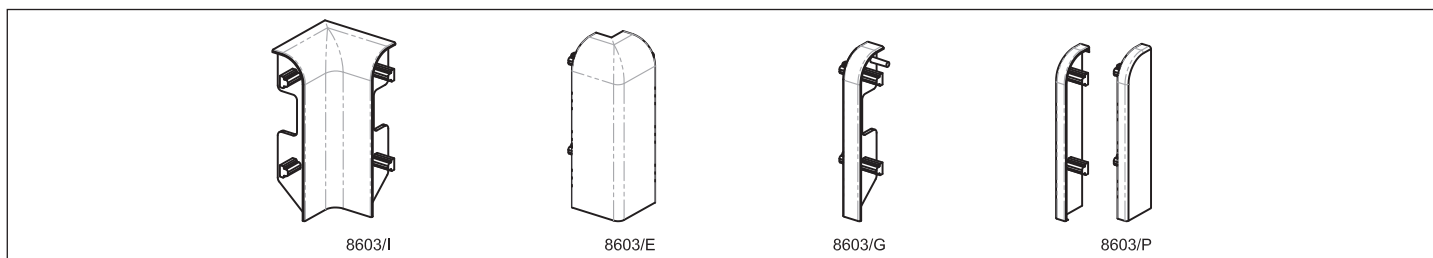

8603/I

8603/E

8603/G

8603/P

INSIDE CORNER

pack 10 pcs

POLYPROPYLENE

H = 70 mm

ART. decors

	532	30194
	542	30204
	545	30208
8603/I	white 555	30210
	light grey 556	30212
	black 557	30214

euro/pc

no partial packaging

JUNCTION

pack 10 pcs

POLYPROPYLENE

H = 70 mm

ART. decors

	532	30294
	542	30304
	545	30308
8603/G	white 555	30310
	light grey 556	30312
	black 557	30314

euro/pc

no partial packaging

OUTSIDE CORNER

pack 10 pcs

POLYPROPYLENE

H = 70 mm

ART. decors

	532	30244
	542	30254
	545	30258
8603/E	white 555	30260
	light grey 556	30262
	black 557	30264

euro/pc

no partial packaging

RIGHT/LEFT END CAPS

pack 10 pcs

POLYPROPYLENE

H = 70 mm

ART. decors

	532	30344
	542	30354
	545	30358
8603/P	white 555	30360
dx/sx	light grey 556	30362
	black 557	30364

euro/pc

no partial packaging

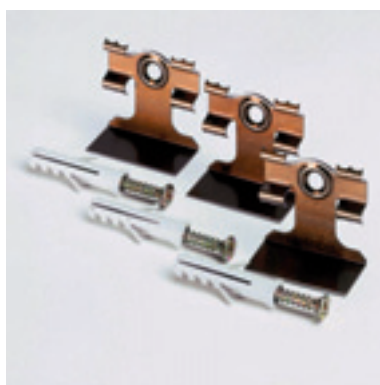

8602/C fixing clips

FIXING CLIPS

10 blister packs/ 20 pcs/blister

8602/C

29750

euro/blister



For a single piece, see sales conditions on page 305



8607 Foam PVC decor 555

PVC Line 8607 is a foam PVC skirting board, 70 mm high and impact resistant. It is particularly suitable for DIY installation, thanks to the speed and easiness of application. It is available in different colours and it can be installed with a simple interlocking system with harmonic stainless steel clips. In addition to its decorative use, it allows to hide the expansion gap perimeter of floating wood and laminate floors.

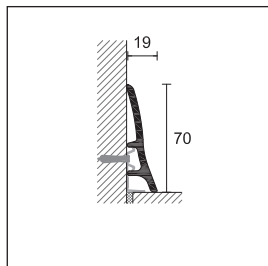

8607

PVC LINE

length 250 cm - pack 40 pcs

FOAM PVC

H = 70 mm

ART. decors

	532	30414
	542	30424
	545	30428
8607	white 555	30430
	light grey 556	30432
	black 557	30434

euro/m

no partial packaging

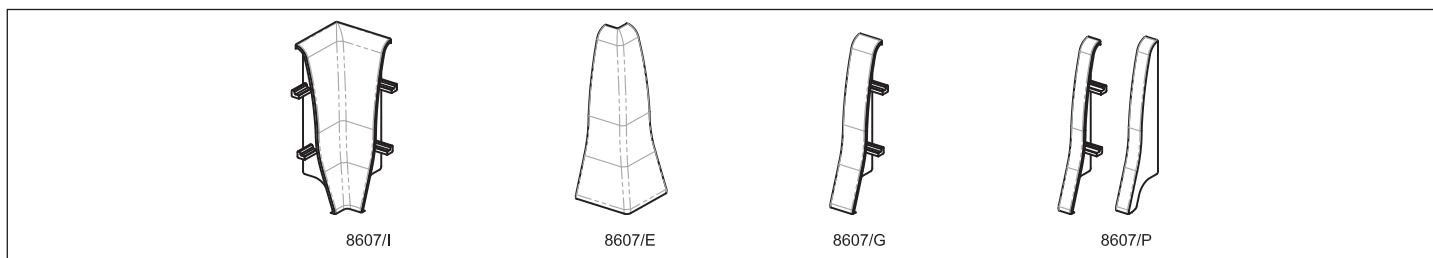

8607/I

8607/E

8607/G

8607/P

INSIDE CORNER

pack 10 pcs

POLYPROPYLENE

H = 70 mm

ART. decors

	532	30464
	542	30474
	545	30478
8607/I	white 555	30480
	light grey 556	30482
	black 557	30484

euro/pc

no partial packaging

JUNCTION

pack 10 pcs

POLYPROPYLENE

H = 70 mm

ART. decors

	532	30564
	542	30574
	545	30578
8607/G	white 555	30580
	light grey 556	30582
	black 557	30584

euro/pc

no partial packaging

OUTSIDE CORNER

pack 10 pcs

POLYPROPYLENE

H = 70 mm

ART. decors

	532	30514
	542	30524
	545	30528
8607/E	white 555	30530
	light grey 556	30532
	black 557	30534

euro/pc

no partial packaging

RIGHT/LEFT END CAPS

pack 10 pcs

POLYPROPYLENE

H = 70 mm

ART. decors

	532	30614
	542	30624
	545	30628
8607P	white 555	30630
dx/sx	light grey 556	30632
	black 557	30634

euro/pc

no partial packaging

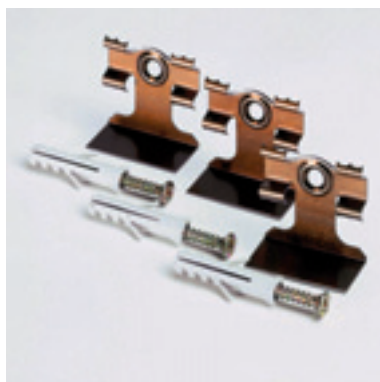

8602/C fixing clips

FIXING CLIPS

10 blister packs/ 20 pcs/blister

8602/C

29750

euro/blister

For a single piece, see sales conditions on page 305





PVC line 148 is a PVC skirting board for carpet and pvc coverings consisting of: a base in rigid PVC and SOFT PVC clip. Used as connecting cove, it allows once laid and reassembled the coating to form a rounded cove. It also allows to hide the ends of the carpet and PVC installed covering any inaccuracies cutting. The profile is recommended for communities, hospitals and schools.

148/B + 148/C PVC light grey

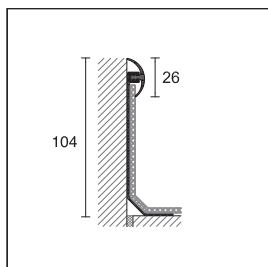

148/B +
148/C

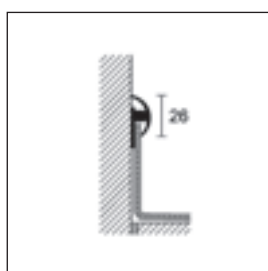

148/BR +
148/C

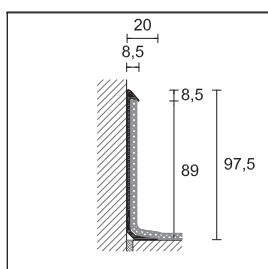

172

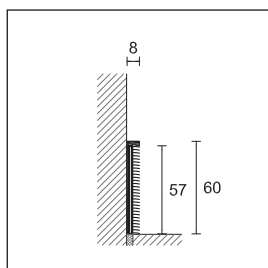

173

PVC LINE - BASE

length = 300 cm - pack 30 pcs

ART. finishing

WHITE RIGID PVC

148/B	PVC white	<input type="checkbox"/>	19095
	<i>euro/m</i>		
148/BR	PVC white	<input type="checkbox"/>	19094
	<i>euro/m</i>		

no partial packaging

PVC LINE - CLIP

length = 305 cm - pack 30 pcs

ART. finishing

SOFT PVC

148/C	PVC white	<input type="checkbox"/>	19096
	PVC ash grey	<input checked="" type="checkbox"/>	19097
	PVC sand	<input type="checkbox"/>	19098
	<i>euro/m</i>		

no partial packaging

PVC LINE

length = 300 cm - pack 20 pcs

ART. finishing	H		
PVC	100		
172	PVC white	<input type="checkbox"/>	19210
	<i>euro/m</i>		

no partial packaging

length = 300 cm - pack 20 pcs

ART. finishing	H		
ALUMINIUM	60		
173	silver anodised drilled	<input checked="" type="checkbox"/>	19215
	<i>euro/m</i>		

no partial packaging

MS POLYMER-BASED ADHESIVE FOR SKIRTING BOARDS

quantity 290 ml - pack 24 pcs

PP/96	78301
<i>euro/pc</i>	

output 10/15 m for cartridge

148/C is available in different colours on request

For a single piece, see sales conditions on page 305



171 black PVC

PVC Line 170, 169 and 171 are a line of cove-shaped profiles of connection in plasticized PVC. Recommended for the laying of carpet and PVC, they adapt the curvature between floor and wall.

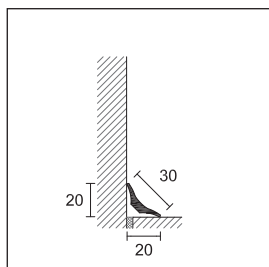

170

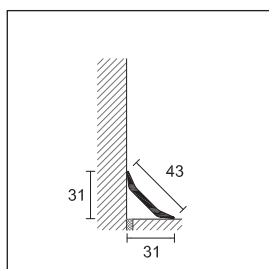

169

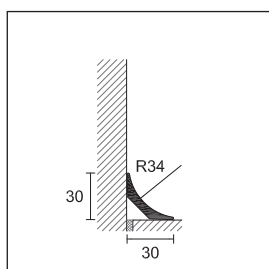

171

PVC LINE - COVE-SHAPED

length = 200 cm - pack 50 pcs H

ART. finishing **20**

PVC

170	black	■	19200
	<i>euro/m</i>		

no partial packaging

PVC LINE - COVE-SHAPED

length = 200 cm - pack 50 pcs H

ART. finishing **31**

PVC

169	black	■	19195
	<i>euro/m</i>		

no partial packaging

PVC LINE - COVE-SHAPED

length = 200 cm - pack 50 pcs H

ART. finishing **30**

PVC

171	black	■	19205
	<i>euro/m</i>		

no partial packaging

All articles PVC line cove-shaped should be stored horizontally.







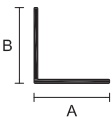
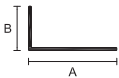
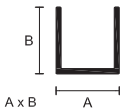
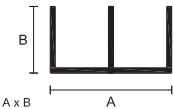

For a single piece, see sales conditions on page 305

DIY profiles

A wide range of DIY profiles in aluminium, stainless steel and brass, available in many measures. Suitable to solve professional and bricolage works.



profiles in anodised aluminium

		with barcode label			
		length m. 1		length m. 2	
	measures	silver	euro/pc	silver	euro/pc
flat 	12x2	10100		10104	
	15x2	10108		10112	
	20x2	10116		10120	
	25x2	10124		10128	
	30x2	10132		10136	
	40x2	-		-	
	50x2	-		-	
	60x2	-		-	
corner 	10x10x1	10140		10144	
	15x15x1	10148		10152	
	20x20x1*	10156		10160	
	25x25x1*	10164		10168	
	30x30x1*	10172		10176	
	30x30x1,5	-		09020	
	40x40x1,5	10380		10384	
	40x40x2	-		-	
	50x50x2	-		-	
corner L 	15x10x1	10180		10184	
	20x10x1	10188		10192	
	30x15x1	10196		10200	
U profile 	8x8x1	10204		10208	
	10x10x1	10212		10216	
	10x15x1	10220		10224	
	12x12x1			10218	
double U profile 	16x7x1	10228*		10232	
	16x12x1	10236		10240	
	20x10x1			10248	
	20x18x1	10252		10256	
edge trim 	18x1	10260		10264	
	22x1	10268		10272	
	25x1	10276		10280	
round tube 	8x1	09032		09036	
	10x1	09040		09044	
	12x1	09048		09052	
	15x1	10284		10288	
	18x1	10292		10296	
	20x1	10300		10304	
	25x1,5			09060	
square tube 	10x10x1	10308		10312	
	15x15x1	10316		10320	
	20x20x1	10324		10328	
rectangular tube 	20x10x1	10332		10336	
	30x15x1	10340		10344	
T profile 	15x15x1,5	10348		10352	
	25x25x1,5	10356		10360	
round bar 	Ø 6			09084	
	Ø 8	10364		10368	
	Ø 10			09092	
square bar 	8x8	10372		10376	
	10x10			10394	

* Out of production items, available till end of stock
Articles no partial packaging. Pack. 10 pcs per item - Minimum order : 100 assorted pcs DIY range.









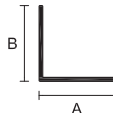

* items available also 3 m long without barcode pag 262

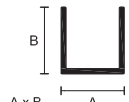
For a single piece, see sales conditions on page 305

EAN 13 = the first group product code

example code 10395 = 8010937 10395

profiles in anodised aluminium

		without barcode label				
		length m. 2		length m. 3		
		silver	euro/pc	silver	euro/pc	
flat		measures				
		12x2	510104	-		
		15x2	510112	-		
		20x2	510120	-		
		25x2	510128	-		
		30x2	510136	-		
		40x2	510095	510096		
		50x2	510099	510097		
corner		10x10x1	510144	-		
		15x15x1	510152	-		
		20x20x1	510160	510158		
		25x25x1	510168	510166		
		30x30x1	510176	510174		
		30x30x1,5	509020	-		
		40x40x1,5	510384	-		
		40x40x2	510381	510383		
		50x50x2	510382	510387		
		corner L		15x10x1	510184	
20x10x1	510192					
30x15x1	510200					
U profile		8x8x1	510208			
		10x10x1	510216			
		10x15x1	510224			
		12x12x1	510218			
double U profile		16x7x1	510232			
		16x12x1	510240			
		20x10x1	510248			
		20x18x1	510256			
edge trim		18x1	510264			
		22x1	510272			
		25x1	510280			
round tube		8x1	509036			
		10x1	509044			
		12x1	509052			
		15x1	510288			
		18x1	510296			
		20x1	510304			
		25x1,5	509060			
square tube		10x10x1	510312			
		15x15x1	510320			
		20x20x1	510328			
rectangular tube		20x10x1	510336			
		30x15x1	510344			
T profile		15x15x1,5	510352			
		25x25x1,5	510360			
round bar		Ø 6	509084			
		Ø 8	510368			
		Ø 10	509092			
square bar		8x8	510376			
		10x10	510394			







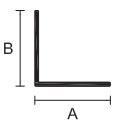
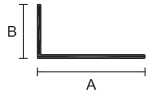
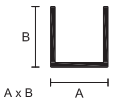

Articles no partial packaging. Pack. 10 pcs per item - Minimum order : 100 assorted pcs DIY range.

EAN 13 = the first group product code

example code 10395 = 8010937 10395

For a single piece, see sales conditions on page 305

profiles in anodised and colour-coated aluminium

		with barcode label length m. 2			
	measures	gold anodised	titanium anodised	colour-coated white	euro/pc
flat		12x2	10105	-	-
		15x2	10113	10468 *	11612
		20x2	10121	10470	11620
		25x2	10129 *	10472 *	-
		30x2	10137	-	11636
corner		10x10x1	10145	10452	11644
		15x15x1	10153	10454	11652
		20x20x1	10161	10456	11660
		25x25x1	10169	10458	11668
		30x30x1	10177	10460 *	11676
		30x30x1,5	09021 *	-	-
		40x40x1,5	10385	-	11684
corner L		15x10x1	10185	10462	11692
		20x10x1	10193	10464	11700
		30x15x1	10201	10466	11708
U profile		8x8x1	10209	-	-
		10x10x1	10217 *	10476 *	11724
		10x15x1	10225	-	-
double U profile		16x7x1	10233 *	-	-
		16x12x1	10241 *	-	-
		20x10x1	10249 *	-	-
		20x18x1	10257 *	-	11764
edge trim		18x1	10265	10474 *	11772
		22x1	10273	-	-
		25x1	10281	-	-
round tube		10x1	09045	-	-
		15x1	10289 *	-	11796
		18x1	10297	-	-
		20x1	10305	-	-
square tube		10x10x1	10313 *	-	11820
		15x15x1	10321 *	-	-
		20x20x1	10329 *	-	-
rectangular tube		20x10x1	10337	-	11844
		30x15x1	10345 *	-	-
T profile		15x15x1,5	10353 *	-	11860
		25x25x1,5	10361 *	-	11868
round bar		Ø 8	10369 *	-	-
square bar		8x8	10377 *	-	-
		10x10	10395 *	-	-

* Out of production items, available till end of stock
Articles no partial packaging. Pack. 10 pcs for gold items, 5 pcs for titanium items





Minimum order: 100 assorted pcs DIY range.

For a single piece, see sales conditions on page 305

EAN 13 = the first group product code

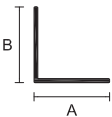
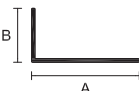
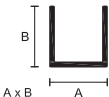
example code 10395 = 8010937 10395

profiles in bright polished silver aluminium

		with barcode label			
		length m. 1		length m. 2	
	measures	silver	<i>euro/pc</i>	silver	<i>euro/pc</i>
flat 	15x2	10111 *		10115	
	20x2	10119 *		10123	
	25x2	10127 *		10131	
corner 	10x10x1	10143		10147	
	15x15x1	10151		10155	
	20x20x1	10159		10163	
	25x25x1	10167 *		10171	
	30x30x1	10175 *		10179	
corner L 	15x10x1	10183 *		10186	
	20x10x1	10191 *		10195	
	30x15x1	10199 *		10203	
U profile 	10x10x1	10215 *		10219	
	10x15x1	10223 *		10227	
	12x12x1	-		10211	
edge trim 	18x1	10263 *		10267	
round tube 	15x1	10287 *		10291	
T profile 	15x15x1,5	10351		10355	

* Out of production items, available till end of stock
Pack. 5 pcs per article

Minimum order: 100 assorted pcs DIY range.

For a single piece, see sales conditions on page 305

polished brass and stainless steel corners

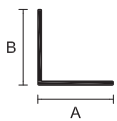
		with barcode label			
		length m. 2			
corner	measures	polished brass	<i>euro/pc</i>	stainless steel	<i>euro/pc</i>
	15x15x1	10002		10050	
	20x20x1	10006		10054	
	25x25x1			10058	
	30x30x1	10014		10062	
	40x40x1	10022 *		10070	
corner L	15x10x1	10030			
	20x10x1	10034		10082	
	30x10x1			10086	
	30x15x1	10042 *			

Articles no partial packaging.

Pack. 5 pcs per article - Minimum order: 100 assorted pcs DIY range.

EAN 13 = the first group product code

example code 10094 = 8010937 10094

curtain counterweights in silver anodised aluminium with rounded edges

		length m. 1		length m. 2		length m. 4	
	measures	cod.	<i>euro/pc</i>	cod.	<i>euro/pc</i>	cod.	<i>euro/pc</i>
	30x4 boxes pcs 10	10604		10605		10606	
	40x4 boxes pcs 10	10608		10609		10610 *	

Articles no partial packaging.



EAN 13 = the first group product code

example code 10824 = 8010937 10824

* Out of production items, available till end of stock

For a single piece, see sales conditions on page 305

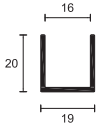
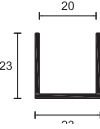
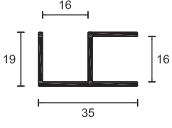
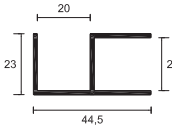
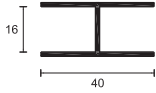
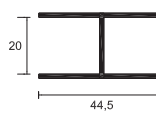
silver anodised aluminium profiles for structures

				with barcode label			
				length m. 2		length m. 3	
		measures	thickness	cod.	euro/pc	cod.	euro/pc
U profile		for panels frame thickness up to 16 mm Packaging 6 pcs per item.	16	1,5	10500		10504
U profile		for panels frame thickness up to 20 mm Packaging 6 pcs per item.	20	1,5	10532		10536
double U profile		for 90° corners between panel boards thickness up to 16 mm Packaging 6 pcs per item.	16	1,5	10508 *		10512
double U profile		for 90° corners between panel boards thickness up to 20 mm Packaging 6 pcs per item.	20	1,5	10540 *		10544
H profile		for connection of panels thickness up to 16 mm Packaging 6 pcs per item.	16	1,5	10516 *		10520
H profile		for connection of panels thickness up to 20 mm Packaging 6 pcs per item.	20	1,5	10548 *		10552 *
double U profile		for 120° corners between panel boards thickness up to 20 mm. Necessary for sloping -roof (120°) of garage, greenhouses, etc. Packaging 6 pcs per item.	20	1,5	10524 *		10528 *

* Out of production items, available till end of stock

For a single piece, see sales conditions on page 305





supports for raised floors

With the new supports for raised floors PP Level Duo® by Profilpas, there is the possibility to choose between fixed and self-levelling head in an instant, directly during the installation. A choice that can be made easily, thanks to the special converter Perfect Ring. Indeed, if you insert it between the head and the screw, the support becomes fixed. On the contrary, if there is the need to compensate the slope of a surface up to 6%, it will be sufficient not to insert the ring to obtain a self-levelling system.



pp level duo® - complete support



PPlevelDUO®

- speed of installation: just 5 seconds to assemble the support.
- height adjustment from the top through adjustment key.
- adjustable supports with wide excursion of available heights.
- the solid and blunt base impedes the incision of the waterproofing membrane.
- acoustic insulation: noise-proof rubber intergated with the head.
- a system of draining holes and canalizations impedes the stagnation of water in every part of the support.
- solid support base of 340 cm² for a better distribution of the weight.
- precise adjustment of the slope to guarantee a perfect flat surface.
- usable in spaces with temperatures from - 40° C to + 80° C.
- pre-cut tabs for 2, 3 and 4 mm joints.
- ecological: all the support is made of recyclable plastic materials.



pp level duo® - complete support



25/37/4



37/61/4



60/105/4



94/169/4



150/280/4



239/320/4

PP LEVEL DUO® - HEAD + SCREW + BASE

head for 4-mm joints - tabs H 12 mm

ART.			pack	pallet
25/37/4	head + screw + base adjustable from h 25 to 37 mm <i>euro/pc (euro/pack)</i>	19360	25 pcs	1250 pcs
37/61/4	head + screw + base adjustable from h 37 to 61 mm <i>euro/pc (euro/pack)</i>	19361	25 pcs	900 pcs
60/105/4	head + screw + base adjustable from h 60 to 105 mm <i>euro/pc (euro/pack)</i>	19362	25 pcs	500 pcs
94/169/4	head + screw + base adjustable from h 94 to 169 mm <i>euro/pc (euro/pack)</i>	19363	25 pcs	400 pcs
150/280/4	head + screw + base adjustable from h 150 to 280 mm <i>euro/pc (euro/pack)</i>	19364	25 pcs	300 pcs
239/320/4	head + screw + extension element + base adjustable from h 239 to 320 mm <i>euro/pc (euro/pack)</i>	19365	25 pcs	300 pcs

no partial packaging

EXTENSION ELEMENT FOR PP LEVEL DUO®

ART.			pack	pallet
P1/80	extension element h 80 mm <i>euro/pc (euro/pack)</i>	19380	25 pcs	500 pcs

no partial packaging

	H. 319/400	H. 399/480	H. 479/560	H. 559/640	H. 639/720	H. 719/800	H. 799/880	H. 879/960	H. 959/1040
art. 239/320/4 cod. 19365	1 pcs	1 pcs	1 pcs	1 pcs	1 pcs	1 pcs	1 pcs	1 pcs	1 pcs
art. P1/80 cod. 19380	1 pcs	2 pcs	3 pcs	4 pcs	5 pcs	6 pcs	7 pcs	8 pcs	9 pcs

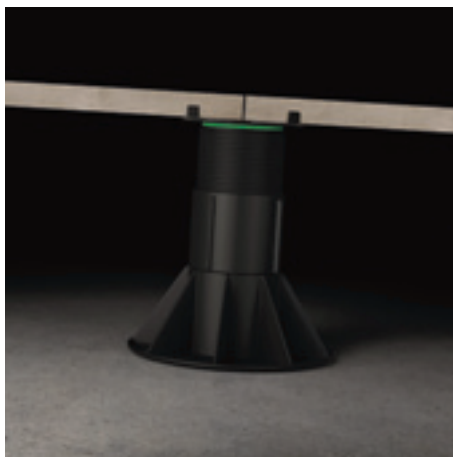

with Perfect Ring, the support is fixed



without Perfect Ring, the support is self-levelling

pp level duo® - modular support

PP level DUO® - Other heads

PP Level DUO® supports are extremely versatile thanks to the possibility to choose between different heads for ceramic tiles (with 2, 3 and 4 mm tabs) or decking. Each head can be combined with any adjustable base.

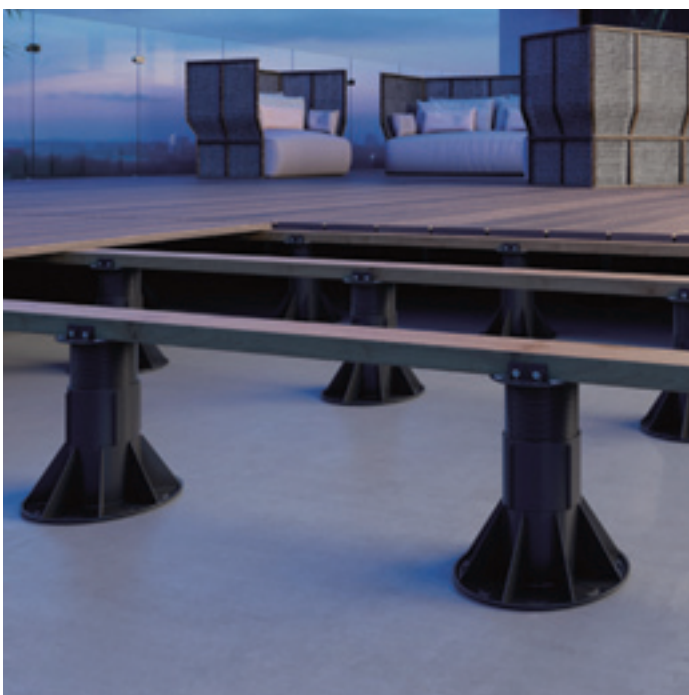

pp level duo® - modular support



PPL/TD



PPL/T2
PPL/T3
PPL/T4



25/37/B



37/61/B



60/105/B



94/169/B



150/280/B



239/320/B

PP LEVEL DUO® - HEAD FOR DECKING

ART.			pack	pallet
PPL/TD	head for decking	19399	25 pcs	500 pcs
	<i>euro/pc (euro/pack)</i>			

no partial packaging

PP LEVEL DUO® - HEAD FOR 2, 3 AND 4 MM JOINTS

ART.			pack	pallet
PPL/T2	head for 2 mm joints	19370	25 pcs	500 pcs
	<i>euro/pc (euro/pack)</i>			
PPL/T3	head for 3 mm joints	19374	25 pcs	500 pcs
	<i>euro/pc (euro/pack)</i>			
PPL/T4	head for 4 mm joints	19371	25 pcs	500 pcs
	<i>euro/pc (euro/pack)</i>			

no partial packaging

PP LEVEL DUO® - BASE + SCREW

ART.			pack	pallet
25/37/B	base + screw adjustable from h 25 to 37 mm	19390	25 pcs	1250 pcs
	<i>euro/pc (euro/pack)</i>			
37/61/B	base + screw adjustable from h 37 to 61 mm	19391	25 pcs	900 pcs
	<i>euro/pc (euro/pack)</i>			
60/105/B	base + screw adjustable from h 60 to 105 mm	19392	25 pcs	500 pcs
	<i>euro/pc (euro/pack)</i>			
94/169/B	base + screw adjustable from h 94 to 169 mm	19393	25 pcs	400 pcs
	<i>euro/pc (euro/pack)</i>			
150/280/B	base + screw adjustable from h 150 to 280 mm	19394	25 pcs	300 pcs
	<i>euro/pc (euro/pack)</i>			
239/320/B	base + screw + extension element adjustable from h 239 to 320 mm	19395	25 pcs	300 pcs
	<i>euro/pc (euro/pack)</i>			

no partial packaging

EXTENSION ELEMENT FOR PP LEVEL DUO®

ART.			pack	pallet
P1/80	extension element h 80 mm	19380	25 pcs	500 pcs
	<i>euro/pc (euro/pack)</i>			

no partial packaging

	H. 318/400	H. 399/480	H. 479/560	H. 558/640	H. 639/720	H. 719/800	H. 799/880	H. 879/960	H. 959/1040
art. 239/320/B cod. 19395 + testa a scelta	1 pcs	1 pcs	1 pcs	1 pcs	1 pcs	1 pcs	1 pcs	1 pcs	1 pcs
art. P1/80 cod. 19380	1 pcs	2 pcs	3 pcs	4 pcs	5 pcs	6 pcs	7 pcs	8 pcs	9 pcs

pp level duo® - double joist system



PP level DUO® - double joist system

The aluminium joists system is the ideal solution for the installation of single-format and multiformat ceramic tiles. Thanks to this system, the installation is always precise and, at the same time, guarantees great stability and resistance.

Profilpas double joist system is composed of two joists in natural aluminium that must be fixed on a special head, thus creating a rail for the positioning of the spacer. The spacer, thanks to its removable tabs, guarantees a correct position of the tiles and creates the 4-mm joint.

- the double joist system is not visible from the joint.
- the double joist system avoids water stagnation and the accumulation of dust and filth.
- thanks to the space between the two joists, it is possible to adjust the height of the support through the specific key.

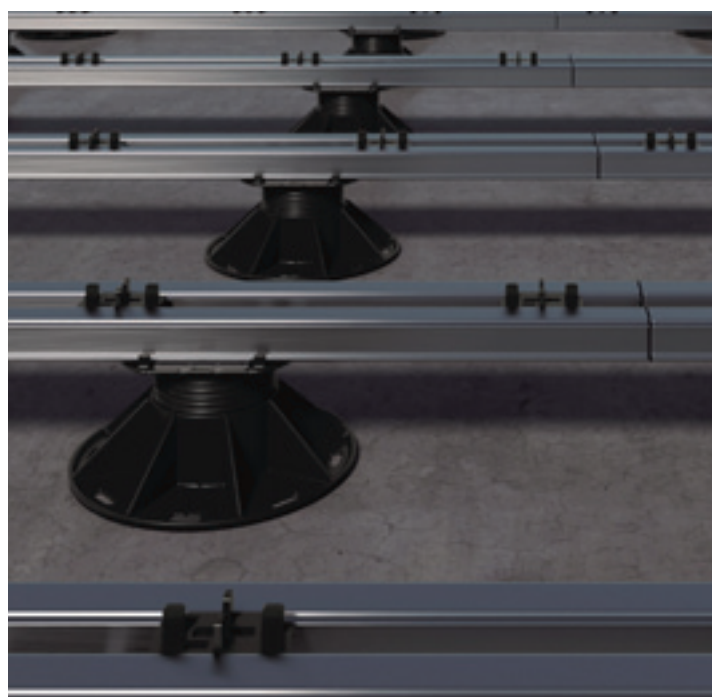
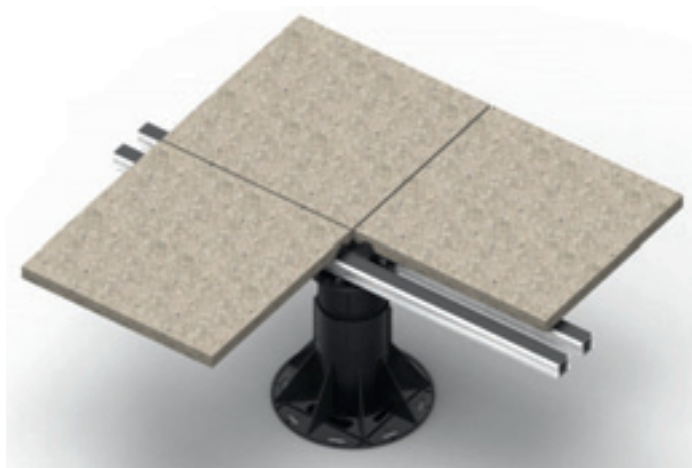

pp level duo® - double joist system



PPL/TA

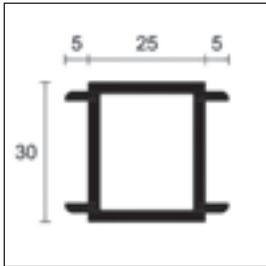

PPL/T



PPL/D4



PPL/GM

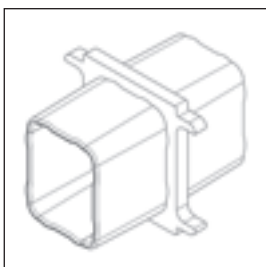

PPL/GR

PP LEVEL DUO® - HEAD AND ACCESSORIES FOR THE DOUBLE JOIST SYSTEM

ART.			pack	pallet
PPL/TA	head for aluminium joists <i>euro/pc (euro/pack)</i>	19396	25 pcs	500 pcs
PPL/T	aluminium joist L 2000 mm <i>euro/m (euro/pack)</i>	19397	10 pcs	200 pcs
PPL/D4	4-mm spacer for aluminium joists <i>euro/pc (euro/pack)</i>	19398	500 pcs	-
PPL/GM	noise-proof rubber 20x2 mm - 20 meters roll <i>euro/m (euro/pack)</i>	19372	5 pcs	-
PPL/GR	connection for joists <i>euro/pc (euro/pack)</i>	19373	250 pcs	-

no partial packaging

The aluminium joists must be installed in pairs.

PP LEVEL DUO® - BASE + SCREW

ART.			pack	pallet
25/37/B	base + screw adjustable from h 25 to 37 mm <i>euro/pc (euro/pack)</i>	19390	25 pcs	1250 pcs
37/61/B	base + screw adjustable from h 37 to 61 mm <i>euro/pc (euro/pack)</i>	19391	25 pcs	900 pcs
60/105/B	base + screw adjustable from h 60 to 105 mm <i>euro/pc (euro/pack)</i>	19392	25 pcs	500 pcs
94/169/B	base + screw adjustable from h 94 to 169 mm <i>euro/pc (euro/pack)</i>	19393	25 pcs	400 pcs
150/280/B	base + screw adjustable from h 150 to 280 mm <i>euro/pc (euro/pack)</i>	19394	25 pcs	300 pcs
239/320/B	base + screw + extension element adjustable from h 239 to 320 mm <i>euro/pc (euro/pack)</i>	19395	25 pcs	300 pcs

no partial packaging

EXTENSION ELEMENT FOR PP LEVEL DUO®

ART.			pack	pallet
P1/80	extension element h 80 mm <i>euro/pc (euro/pack)</i>	19380	25 pcs	500 pcs

no partial packaging

	H. 318/400	H. 399/480	H. 479/560	H. 558/640	H. 639/720	H. 719/800	H. 799/880	H. 879/960	H. 959/1040
art. 239/320/B cod. 19395 + testa a scelta	1 pcs	1 pcs	1 pcs	1 pcs	1 pcs	1 pcs	1 pcs	1 pcs	1 pcs
art. P1/80 cod. 19380	1 pcs	2 pcs	3 pcs	4 pcs	5 pcs	6 pcs	7 pcs	8 pcs	9 pcs

pp level fix - complete support



PP Level FIX is a new line of supports with fixed head. Available for heights from 25 to 280 mm, PP Level Fix supports can be adjusted in height from the top, thanks to the specific adjustment key.

PP Level Fix



25/37/4F



37/61/4F



60/105/4F



94/169/4F



150/280/4F

PP LEVEL FIX

head for 4-mm joints - tabs h 12 mm

ART.			pack	pallet
25/37/4F	head + screw + base adjustable from h 25 to 37 mm <i>euro/pc (euro/pack)</i>	19340	25 pcs	1250 pcs
37/61/4F	head + screw + base adjustable from h 37 to 61 mm <i>euro/pc (euro/pack)</i>	19341	25 pcs	900 pcs
60/105/4F	head + screw + base adjustable from h 60 to 105 mm <i>euro/pc (euro/pack)</i>	19342	25 pcs	500 pcs
94/169/4F	head + screw + base adjustable from h 94 to 169 mm <i>euro/pc (euro/pack)</i>	19343	25 pcs	400 pcs
150/280/4F	head + screw + base adjustable from h 150 to 280 mm <i>euro/pc (euro/pack)</i>	19344	25 pcs	300 pcs

no partial packaging

pp level mini



PP Level Mini

PP Level Mini is a support with fixed head, for heights from 10 to 15 mm. With maximum two extension elements P/5, there is the possibility to reach an height of 25 mm.



10/15



P/5

PP LEVEL MINI

head for 4-mm joints - tabs h 10 mm

ART.

pack

10/15	adjustable support from h 10 to 15 mm <i>euro/pc (euro/pack)</i>	19351	20 pcs
P/5	extension element of 5 mm thickness for art. 10/15 (maximum two elements = +10 mm) <i>euro/pc (euro/pack)</i>	19350	20 pcs

no partial packaging



SP1

SP1 is a support to be used for the positioning of grit and concrete slabs. It can be installed with the correctors SP2 and SP3, according to the desired slope of the flooring. SP1 guarantees the outflow of rainwater and allows to avoid the direct contact of the flooring with the possible waterproofing layer.

SUPPORT FOR RAISED FLOORS

pack 360 pcs

ART.

SP1	support for grit and concrete slabs diam. 155x14 h	19090
------------	--	-------

euro/pc (euro/pack)

no partial packaging

CORRECTORS FOR RAISED FLOORS

pack 1000 pcs

ART.

SP2	corrector for support SP1 thickness 1 mm	19092
------------	--	-------

euro/pc (euro/pack)

pack 500 pcs

ART.

SP3	corrector for support SP1 thickness 3 mm	19093
------------	--	-------

euro/pc (euro/pack)

no partial packaging



SP2



SP3

pp level duo® - accessories



Stainless steel clips PCC/01 and PCC/02

Among the accessories for the installation of outdoor raised floors, in addition to the adjustment key from the top, there is a full system for the creation of perfect steps and vertical risers. PCC/01 and PCC/02 are two clips that must be installed on the head and under the base of perimetral and corner supports: the tile must be positioned among the two clips in order to create a perfect step. This result can be also obtained with PCC/03, a clip for the installation close to vertical walls that allows to keep always the same distance between the wall and the tiles.

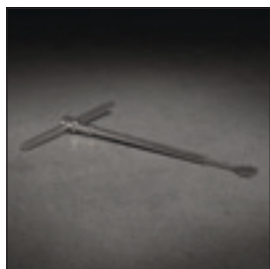

CR/N



KIT PCC/01

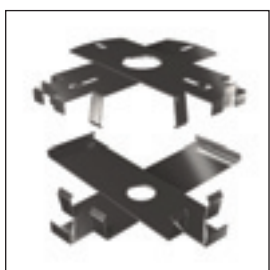

KIT PCC/02



PCC/03

PP LEVEL DUO® ACCESSORIES

ART.		pack	
PCC/01	perimetral clip (base + head) <i>euro/kit</i>	19382	30 Kit
PCC/02	corner clip (base + head) <i>euro/kit</i>	19383	4 Kit
PCC/03	wall clip <i>euro/pc</i>	19384	50 pcs
CR/N	adjustment key <i>euro/pc</i>	19381	12 pcs

no partial packaging (except for CR/N)

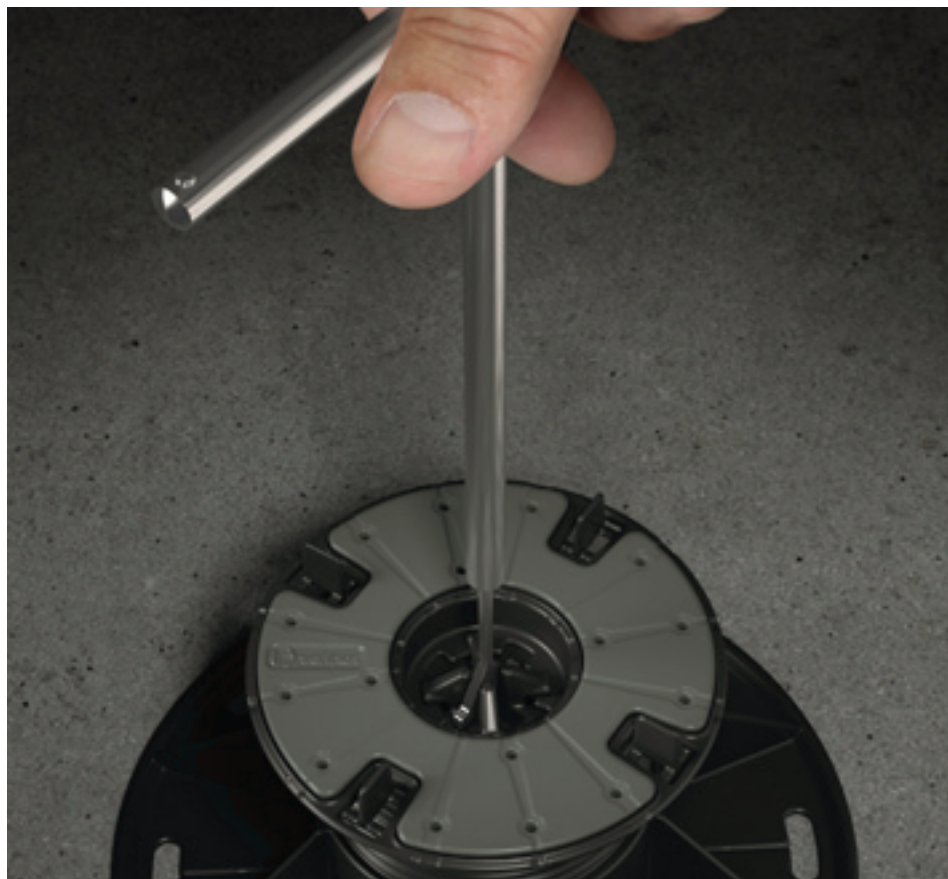



Protec CPLV is a series of edge profiles to protect and finish the borders of raised floors. Available in ash grey RAL 7038 colour-coated aluminium, they are composed of a drilled CPLB base to be anchored to the floor supports with screws, and a top part to be fixed with adhesive, available in 3 different heights according to the floor thickness.

CPLB + CPLV/60 ash grey RAL 7038 colour-coated aluminium

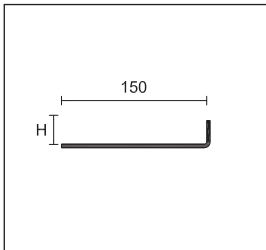
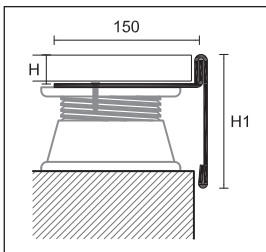

CPLB

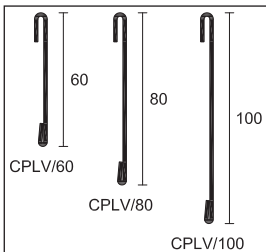

CPLV/

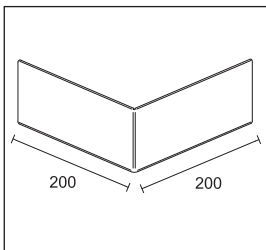

CPLV/ /E

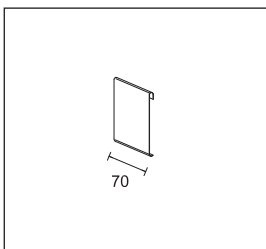

CPLV/ /G

PROTEC

length = 270 cm - pack 10 pcs	H
-------------------------------	----------

BASE

ART. finishing	20
-----------------------	-----------

ALUMINIUM

CPLB natural aluminium		86900
-------------------------------	--	-------

euro/m

Upon request available also with draining holes. Surcharge euro / m
On request available also version H 15 and 25

PROTEC

length = 270 cm - pack 10 pcs	H1
-------------------------------	-----------

FRONT

ART. finishing	60	80	100
-----------------------	-----------	-----------	------------

ALUMINIUM

CPLV/ colour-coated ash grey RAL 7038		86902	86904	86906
--	--	-------	-------	-------

euro/m

white RAL 9003, dark brown RAL 8019, metal grey RAL 9006, aluminium grey RAL 9007, ancient grey, ash grey RAL 7038 embossed and rust with a minimum of 270 meters, on request, without surcharge. For different colours, please contact our Sales Department.

OUTSIDE CORNER A 90°

pack 5 pcs	H1
------------	-----------

ART. finishing	60	80	100
-----------------------	-----------	-----------	------------

COLOUR-COATED ALUMINIUM

CPLV/ /E colour-coated ash grey RAL 7038		86920	86922	86924
---	--	-------	-------	-------

euro/pc

JUNCTION

width = 70 mm - pack 5 pcs	H1
----------------------------	-----------

ART. finishing	60	80	100
-----------------------	-----------	-----------	------------

COLOUR-COATED ALUMINIUM

CPLV/ /G colour-coated ash grey RAL 7038		86930	86932	86934
---	--	-------	-------	-------

euro/pc

no partial packaging



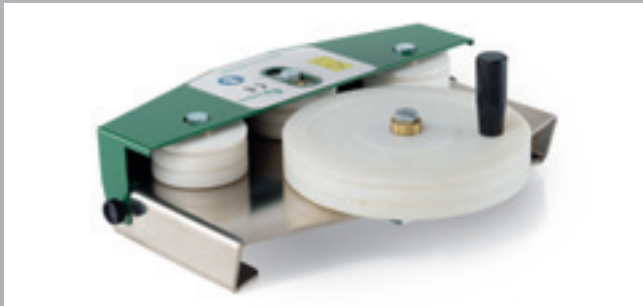

profiles and accessories for installation

Levelling systems for tiles installation, spacers, adhesives, utensils, systems and accessories.





Klic Level

Klic Level is a screw levelling system for floors and coverings of different thickness, particularly suitable for large size tiles. The cylinder incorporates a disk for the protection of the covering surface against scratches during the levelling phase, and a functional mechanism for a rapid insertion and expulsion of the disposable element.



KL/C

CYLINDER WITH ANTI-SCRATCH DISK

pack 10 bags with 50 pcs

ART.

KL/C	cylinder	18015
<i>euro/pc (euro/bag)</i>		

no partial packaging

DISPOSABLE SCREW SPACER

pack 30 bags with 100 pcs

ART.

KL/1	screw for 1-mm grouts and tile thicknesses from 3 to 20 mm	18016
<i>euro/pc (euro/bag)</i>		
KL/1A	screw for 1,5-mm grouts and tile thicknesses from 3 to 20 mm	18019
<i>euro/pc (euro/bag)</i>		
KL/2	screw for 2-mm grouts and tile thicknesses from 3 to 20 mm	18017
<i>euro/pc (euro/bag)</i>		
KL/3	screw for 3-mm grouts and tile thicknesses from 3 to 20 mm	18018
<i>euro/pc (euro/bag)</i>		

no partial packaging



KL/1
KL/1A
KL/2
KL/3

CROSS SPACER FOR OUTDOOR USE

pack 2 bags da 50 pcs

ART.

DCE4	cross spacer for outdoor tiles and 4-mm grouts	19076
<i>euro/pc (euro/bag)</i>		

no partial packaging



DCE4



Fix Level

Fix Level is a screw levelling system for floors and coverings of different thickness, particularly suitable for large size tiles.

The cylinder incorporates a disk for the protection of the covering surface against scratches during the levelling phase.



FL/C

CYLINDER WITH ANTI-SCRATCH DISK

pack 10 bags with 50 pcs

ART.

FL/C	cylinder	18027
	<i>euro/pc (euro/bag)</i>	

no partial packaging

DISPOSABLE SCREW SPACER

pack 30 bags with 100 pcs

ART.

KL/1	screw for 1-mm grouts and tile thicknesses from 3 to 20 mm	18016
	<i>euro/pc (euro/bag)</i>	
KL/1A	screw for 1,5-mm grouts and tile thicknesses from 3 to 20 mm	18019
	<i>euro/pc (euro/bag)</i>	
KL/2	screw for 2-mm grouts and tile thicknesses from 3 to 20 mm	18017
	<i>euro/pc (euro/bag)</i>	
KL/3	screw for 3-mm grouts and tile thicknesses from 3 to 20 mm	18018
	<i>euro/pc (euro/bag)</i>	

no partial packaging



KL/1
KL/1A
KL/2
KL/3

UNSCREWER FOR FIX LEVEL

pack 50 pcs

ART.

NEW SFL	unscrewer for Fix Level	18013
	<i>euro/pc (euro/pack)</i>	

no partial packaging



SFL



Protilex is a levelling system for the laying of ceramic and stone tiles. It is suitable for thicknesses from 3 to 20 mm and impedes the vertical movement between tiles during the adhesive grip phase. Specific pliers are available for the laying of floors and coverings for less effort and saving time.

Protilex



disposable clips installation



tiles laying



levelling wedges insertion



wedges and clips removal



PTLP

ADJUSTABLE TRACTION PLIERS

pack 6 pcs

ART.

PTLP	adjustable traction pliers	18065
	<i>euro/pc</i>	



PTWN

LEVELLING WEDGES

pack 14 bags with 100 pcs

ART.

PTWN	levelling wedges	18063
	<i>euro/pc (euro/bag)</i>	

no partial packaging

DISPOSABLE CLIPS

pack 12 bags with 250 pcs

ART.

NEW PTC	clips for 0,5 mm grouts and tile thicknesses from 3 to 12	18070
	<i>euro/pc (euro/bag)</i>	

PTC1	clips for 1 mm grouts and tile thicknesses from 3 to 12	18071
	<i>euro/pc (euro/bag)</i>	

PTC1A	clips for 1,5 mm grouts and tile thicknesses from 3 to 12	18075
	<i>euro/pc (euro/bag)</i>	

PTC2	clips for 2 mm grouts and tile thicknesses from 3 to 12	18072
	<i>euro/pc (euro/bag)</i>	

PTC3	clips for 3 mm grouts and tile thicknesses from 3 to 12	18073
	<i>euro/pc (euro/bag)</i>	

no partial packaging

pack 60 bags with 50 pcs

PTC4	clips for 2 mm grouts and tile thicknesses from 12 to 20 mm	18074
	<i>euro/pc (euro/bag)</i>	

no partial packaging



PTC
PTC 1
PTC1A
PTC2
PTC3



PTC4

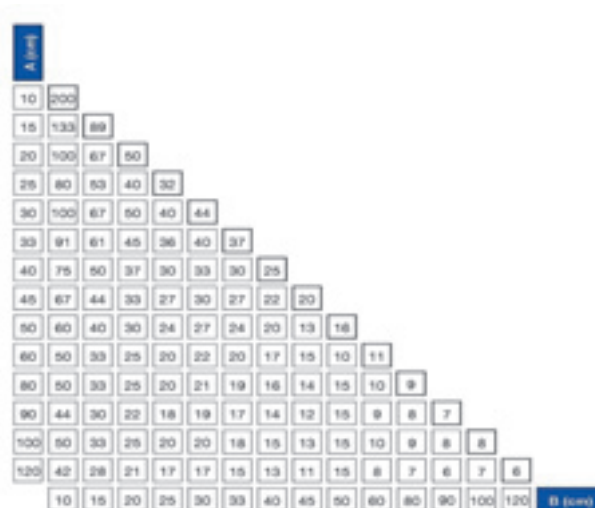



spacer FIVE

Spacer FIVE is a multi-thickness spacer for tiles: just one product for creating different grout spacing of 0,5 - 1 - 1,5 - 2 - 3 mm. The spacer can be used for laying both floors and wall coverings and complies with the regulation UNI 11493-1 since it has been designed to be easily removed and to be used more times. Five Spacer DF guarantees a perfect, quick and cheap laying.



DF

SPACER FIVE

pack 20 bags with 200 pcs

ART.

DF spacer for tiles

19077

euro/pc (euro/bag)

no partial packaging

CROSS SPACERS

box with 20 packaging of 250 pcs

LxH	2x5	3x5	4x5	5x5	7x6	10x8
ART.	DC2 solid	DC3 drilled	DC4 drilled	DC5 drilled	DC7 drilled	DC10 drilled
	19000 *	19006 *	19012 *	19018 *	19024	19030

euro/pack

no partial packaging

CROSS SPACERS

box with 10 packaging of 500 pcs

LxH	1x5	2x5	3x5	4x5	5x5	7x6	10x8
ART.	DC1 solid	DC2 solid	DC3 drilled	DC4 drilled	DC5 drilled	DC7 drilled	DC10 drilled
	18992	19002	19008	19014	19020	19026 *	19032 *

euro/pack

no partial packaging

T SPACERS

box with 20 packaging of 250 pcs

LxH	2x5	3x5	4x5	5x5	7x6	10x8
ART.	DT2 solid	DT3 drilled	DT4 drilled	DT5 drilled	DT7 drilled	DT10 drilled
	19040 *	19046 *	19052 *	19058 *	19064	19070

euro/pack

no partial packaging

T SPACERS

box with 10 packaging of 500 pcs

LxH	1x5	2x5	3x5	4x5	5x5	7x6	10x8
ART.	DT1 solid	DT2 solid	DT3 drilled	DT4 drilled	DT5 drilled	DT7 drilled	DT10 drilled
	19038	19042	19048	19054	19060	19066 *	19072 *

euro/pack

no partial packaging

WEDGES

pack box with 20 packaging of 250 pcs box with 10 packaging of 500 pcs

LxIxH	9x28x5	9x28x5
ART.	CN28	CN28
	19080	19082

euro/pack

no partial packaging

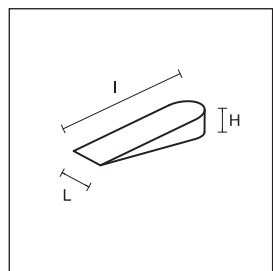
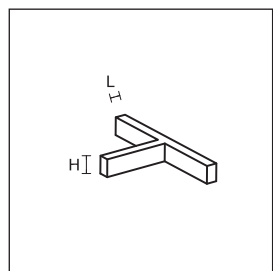
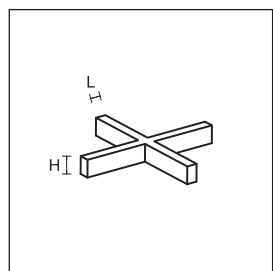

* Out of production items, available till end of stock

For a single piece, see sales conditions on page 305



skirting board adhesive

MS POLYMER-BASED ADHESIVE FOR SKIRTING BOARDS

pack 24 pcs - quantity 290 ml	
PP/96	78301
<i>euro/pc</i>	
output 10/15 m for cartridge	

MAGNETIC KIT

box with 10 blisters	
K10	00410
<i>euro/blister</i>	



magnetic kit

MITRE CUTTER FOR PVC PROFILES *

box with 10 blisters of one piece	
K20- mitre cutter	
<i>euro/pc</i>	

POLISHING PASTE FOR METAL PROFILE CLEANING

pack 20 pcs - quantity 150 ml	
POLISHING PASTE	30018
<i>euro/pc</i>	



mitre cutter for pvc profiles

DOUBLED SIDED ADHESIVE TAPES

	POLYPROPYLENE	COTTON CLOTH
pack	24	24
LxL cm	5x2500	5x2500
ART.	D/4461/K	D/4471/K
	30004	30014
<i>euro/pc</i>		



polishing paste



SCREWS

	FLAT HEAD				ROUND HEAD	
box - 1000 pcs						
finishing	nickel-plated	brass plated	bronze plated	brass plated	nickel-plated	brass plated
LxL mm	3X25	3X25	3X25	3X25	3,5X25	3,5X25
ART.	SS/5	SS/5	SS/5	RR/5	SS/4	SS/4
	68800	68801	68802	68803	68804	68805
<i>euro/box</i>						

* Out of production items, available till end of stock

For a single piece, see sales conditions on page 305

 **profilpas**® MORE VALUE TO YOU

Iceberg Collection
evolution
in full light.



**MORE VALUE
TO YOUR
INNOVATION.**

Profiles and
Skirting Boards
Profilpas Design.



**MORE VALUE
TO YOUR
DESIGN.**

Technical
solutions.



**MORE VALUE
TO YOUR
INSTALLATION.**



merchandising for the point of sale

A series of tools dedicated to the showroom: modular expositive pieces of furniture, counter display boxes, sampleboards, sample boxes, cylinders etc for creating suitable areas for every need of space and products.

OUR PROJECT

New **shower drain systems**, Slim Drain and Smart Drain.



**MORE VALUE
TO YOUR
STYLE.**

UniSystem Plus and Profilpas **Digital System.**



**MORE VALUE
TO YOUR
SOLUTIONS.**





Profipos concept store: a modular display system composed of panels that can be used singularly or combined together. For each panel, there is the possibility to choose the display units according to the products treated.



PANEL 1 terrace picture DIM. CM 90X220 H.	02036	€
PANEL 2 living room picture DIM. CM 90X220 H.	02037	€
PANEL 3 bathroom picture DIM. CM 90X220 H.	02038	€
PANEL 4 staircase picture DIM. CM 90X220 H.	02039	€
SELF-SUPPORTING BASE FOR PANELS	02040	€
DISPLAY UNIT 1 - CPGV+WPSTOP 3	02041	€
DISPLAY UNIT 2 - CPNV+CPCV/30	02042	€
DISPLAY UNIT 3 - SNG+SIR+SIG+SIS+SP+76	02043	€
DISPLAY UNIT 4 - GIN+ILN+ZQIN	02044	€
DISPLAY UNIT 5 - ZQVN Trend Color Stone	02045	€
DISPLAY UNIT 6 - SLIM DRAIN+GLASS PROFILE	02046	€
DISPLAY UNIT 7 - SMART DRAIN	02047	€
DISPLAY UNIT 8 - THIN DRAIN	02048	€
DISPLAY UNIT 9 - case for sample boards (without sample boards)	02049	€
DISPLAY UNIT 10 - 8605+8608	02055	€
DISPLAY UNIT 11 - PP LEVEL DUO	02064	€
DISPLAY UNIT 7/a - shelf only	02056	€

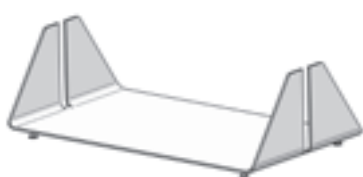

self-supporting base for panels



display unit 1
CPGV - WPstop 3



display unit 7
Smart Drain



display unit 2
CPNV - CPCV/30



display unit 8
Thin Drain



display unit 3
SNG + SIR + SGI + SIS + SP - 76



display unit 9
case for sample boards

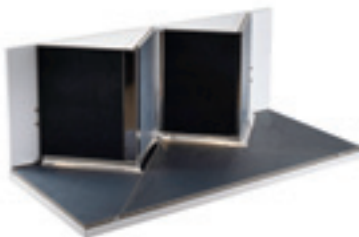

display unit 4
GIN + ILN + ZQIN



display unit 10
8605 - 8608



display unit 5
ZQVN Trend Color Stone



display unit 11
PP Level Duo®



display unit 6
Slim Drain + Glass Profile



display unit 7/A
shelf only



Profilpas offers the possibility to create customizable corners according to the needs and the available spaces. Creating an exposition corner means giving sales support, appraising and promoting products, thus setting the conditions for a sales increase.

customizable display system



black totem for sample boards dim. cm 55x55x200 h	02034	€
NEW white totem for sample boards dim. cm 55x55x200 h.	02035	€



Organizer 6+2 drawers cm 40x50x133 h.	02009	€
Tower display for organizer cm 40x200 h.	02010	€



Cabinet 2 shelves cm 100x50x90 h.	02011	€
-----------------------------------	-------	---

For a single piece, see sales conditions on page 305



Cabinet 2+2 shelves cm 100x50x90 h.

02012

€



Showcase cm 100x30x120 h.

02014

€



Small showcase cm 50x30x120 h.

02013

€

Small showcase cm 50x30x120 h.
Including electrical connections for the
installment of PROLIGHT line.

02031

€



Customized panel board dim. cm 100x160 h.

02032

€

For a single piece, see sales conditions on page 305



display box metal line	00125	€
------------------------	-------	---

folding sampleboard Prolight ITA/ENG (pack of 20 pieces)	02050	€/pz
folding sampleboard Prolight FR/TED (pack of 20 pieces)	02051	€/pz
folding sampleboard Prolight SPA/POR (pack of 20 pieces)	02052	€/pz
folding sampleboard Prolight RUS/CRO (pack of 20 pieces)	02053	€/pz
folding sampleboard Prolight CEC/POL (pack of 20 pieces)	02054	€/pz



Exhibition panels divided for different application categories.
They are also suitable for inclusion in the drawer corner shop.

sampleboard 1	PROLIST decorative listellos and profiles	02015	€
sampleboard 2	external corners profiles PROTRIM	02016	€
sampleboard 3	external corners profiles PROANGLE Q	02017	€
sampleboard 4	external corners profiles PROCORNER internal corners profiles PROROUND	02018	€
sampleboard 5	profiles for small gaps	02019	€
sampleboard 6	profiles for floors of same height	02020	€
sampleboard 7	profiles for floors of different height	02021	€
sampleboard 8	profiles for LVT floors	02022	€
sampleboard 9	Expansion joints PROJJOINT	02023	€
sampleboard 10	profiles for balconies and terraces PROTEC	02024	€
sampleboard 11	stair nosing profiles	02025	€
sampleboard 12	PDS-foiled profiles	02026	€
NEW sampleboard 13/A	METAL LINE 89-90-790	02057	€
NEW sampleboard 13/B	METAL LINE 87-88-92-93-95-97-98-100	02058	€
NEW sampleboard 14	Trend Color Stone	02028	€
NEW sampleboard 15	Trend Color Light	02029	€



brochure Accessories for installation IT/GB	00197	€
brochure Accessories for installation ES/PT	00199	€
KLIC LEVEL - sample kit 4 pcs	00105	€
PROTILER - sample kit 4 pcs	00129	€

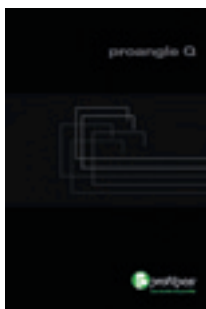

CLASSIC COVER

ART.	finishing		60 cm	
STAINLESS STEEL				
XSC/60	satin stainless steel AISI 304 DIN 1.4301		19524	€
	polished stainless steel AISI 304 DIN 1.4301		19523	€

leaflet WPSTOP IT/GB	00176	€/pz
sample box WPSTOP ITA	00182	€/pz
sample box WPSTOP GB	00183	€/pz
sample box WPSTOP TED	00185	€/pz
sample box WPSTOP SPA	00186	€/pz
sample box WPSTOP POR	00187	€/pz
brochure Glass Profile ITA/GB	00194	€/pz
brochure Glass Profile FR/TED	00195	€/pz
brochure Glass Profile SPA/POR	00196	€/pz

sampleboard stair nosing profiles	00069	€
-----------------------------------	-------	---

pvc skirting board sampleboard	00101	€
--------------------------------	-------	---

sample box PROANGLE Q ITA/GB	00184	€/pz
sample box PROANGLE Q FR/TED	00188	€/pz
sample box PROANGLE Q SPA/POR	00189	€/pz

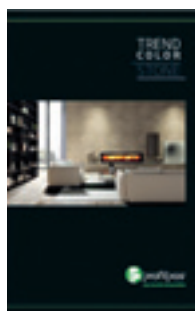





profilpas trend color stone	00152	€
profilpas trend color light	00153	€

white counter display Trend Color Stone	00165	€
black counter display Trend Color Light	00173	€
black counter display Proangle Q	00166	€

brochure PROFILPAS DESIGN ITA/GB	00113	€
----------------------------------	-------	---

leaflet Trend Color Stone ITA/GB	00167	€
leaflet Trend Color Stone FR/TED	00168	€
leaflet Trend Color Stone SPA/POR	00169	€

	sample DJKC/10	00134	€
	sample DJKC/10	00135	€
	sample UKC/10	00136	€
	sample DJKGC/10	00137	€
	sample UKGC/10	00138	€

cylinder wall profiles	00103	€
cylinder floor profiles	00104	€
cylinder small gaps profiles	00114	€
cylinder proangle Q	00115	€
cylinder unisystem	00080	€
cylinder prosystem	00082	€
cylinder proline	00127	€
cylinder LVT	00142	€
cylinder proligh	00143	€

**NEW**

brochure XL Design IT/GB	00265	€
brochure XL Design FR/DE	00266	€
brochure XL Design ES/PT	00267	€
brochure XL Design PL/CZ	00268	€

NEW

leaflet XL Design IT/GB	00269	€
leaflet XL Design FR/DE	00270	€
leaflet XL Design ES/PT	00271	€
leaflet XL Design PL/CZ	00272	€

NEW

sample box XL Design	00245	€
----------------------	-------	---

NEW

counter display Proangle XL Design ZD	00223	€
---------------------------------------	-------	---

**NEW**

brochure PP Level DUO IT/GB	00042	€
brochure PP Level DUO FR/DE	00043	€
brochure PP Level DUO ES/PT	00044	€
brochure PP Level DUO PL/CZ	00045	€
brochure PP Level DUO RU/HR	00046	€

NEW

leaflet PP Level DUO IT/GB	00260	€
leaflet PP Level DUO FR/DE	00261	€
leaflet PP Level DUO ES/PT	00262	€
leaflet PP Level DUO PL/CZ	00263	€
leaflet PP Level DUO RU/HR	00264	€

NEW

sample box PP Level DUO	00038	€
-------------------------	-------	---





PDS bunch



PDS XL bunch

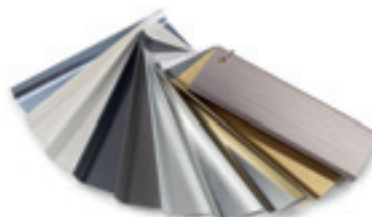

metal line bunch



bunch 8605/8608



pvc skirting board bunch



bunch ZQP



bunch RPA



bunch RE



bunch REM



bunch REC



bunch RECO



DIY bunch



sandblast stainless steel bunch



chromium-plated brass bunch



antibacterial profiles bunch

PDS bunch	00020	€
8605/8608 bunch	00126	€
metal line bunch	00119	€
PVC skirting board bunch	00085	€
profiles for balconies bunch	00117	€
ZQP bunch	00027	€
RPA bunch	00050	€
RE bunch	00011	€
REM bunch	00052	€
REC bunch	00049	€
RECO bunch	00133	€
DIY bunch	00128	€
chromium-plated brass bunch	00130	€
sandblast stainless steel profiles bunch	00132	€
bunch pvc stair nosing	00084	€
bunch antibacterial profiles	00147	€
bunch PDS xl	00140	€
bunch decors PDS lvt	00141	€
NEW bunch black & white	00033	€
NEW bunch ZV Trend Color Light	00035	€
NEW bunch ZV Trend Color Stone	00036	€
NEW bunch IPV Trend Color Stone	00037	€

020/	127	88/6	56 - 237	97/4G	244	155/16	189
023/	130	88/16SF	237 - 238	97/4I	244	156	186
024/	130	88/16L/A	56 - 237	97/4P	244	158	186
025/	130	88/6E	56 - 237	97/4SF	244	161/11	190
026/	128	89/	32 - 38 - 235	97/4TME	244	163/	189
030/	130	89/ EI	32 - 38 - 235	97/4TMG	244	166/16	189
032/SF/	140	89/ TM	235	97/4TMI	244	168/16	190
034/A	140	89/ TMEI	235	97/4TMP	244	169	259
035/	130	89/6L	57	97/4TMSF	244	169/	190
040/	130	89/6EI	57	97/7E	245	170	259
050/	156	89/613	236	97/7G	245	170/	190
060/	156	89/613EI	236	97/7I	245	171	259
076/	83	90/6SA	231	97/7P	245	171/11	190
080/	156	90/ A	231	97/7SF	245	172	258
0100/	156	90/ E	233	97/8CB	246	173	258
6/	141	90/ G	233	97/8E	246	174/	190
7/	141	90/ I	233	97/8G	246	175/11	190
10/	142	90/ MI	32 - 227 - 232	97/8I	246	177/16	190
10/15	276	90/ ME	32 - 227 - 232	97/8P	246	178/16	190
19/	129	90/ MG	32 - 227 - 232	97/8SF	246	210/	81
21/	126	90/ MP	32 - 227 - 232	98/7E	243	220/	81
22/A	205	90/ P	233	98/7G	243	239/320/4	270
23/	129	90/ SE	233	98/7I	243	239/320/B	272
24/	129	90/ SF	32 - 231	98/7P	243	277/	81
25/	129	90/ SG	233	98/7SF	243	300/	142
25/37/4	270	90/ SI	233	99/M	124	305/	141
25/37/B	272	90/ SP	233	99/R/	124	310/	142
30/	126	90/ SSF	231	99/T/	123 - 225	311/	139
31/	126	90/ TE	233	99/TR/26	212	312/	139
35/	126	90/ TG	233	100/	239	345/	135
37/61/4	270	90/ TI	233	101/74	239	355/	137
37/61/B	272	90/ TME	233	105/7	58	358/	137
41/	126	90/ TMG	233	105/7E	58	370/	179
45/	135	90/ TMI	233	105/7G	58	373/	179
46/	141	90/ TMP	233	105/7I	58	380/10	125
50/A	205	90/ TMSF	231	105/7P	58	380/14	125
51/	138	90/ TP	233	105/CB	58	380/3	125
52/	138	90/ TSF	231	105/PL	58	380/4	125
53/	179	91/8SF	236	110/	181	380/5	125
54/	143	92/7	240	111/ /F	178 - 213	380/7	125
55/	137	93/	240	115	182	380/8	125
57/	138	94/169/4	270	117/	182	399/10	124
58/	179 - 207	94/169/B	272	119/	182	399/M	124
58/A	207	95/ E	241	124/	181	399/R/	124
60/105/4	270	95/ G	241	125/	183	399/T/	123 - 225
60/105/B	272	95/ I	241	126/	184	399/TC/	123 - 225
61/	137	95/ P	241	126/L/F	55	399/U	125
63/A	205	95/ SF	241	126/LP/DX	55	419/	129
70/	180	95/ TE	241	126/LP/SX	55	422/AD	205
71/	180	95/ TG	241	128/	184	424/	129
72/	183	95/ TI	241	130/	180	425/	129
73/	179 - 207	95/ TME	241	131/	180	430/	126
74/	179 - 207	95/ TMG	241	148/B	258	441/	126
74/A	207	95/ TMI	241	148/C	258	450/AD	205
74/I	179	95/ TMP	241	150	185	455/	137
75/F	178 - 213	95/ TMSF	241	150/	189	457/	138
76/	181	95/ TP	241	150/280/4	270	461/	137
77/	183	95/ TSF	241	150/280/B	272	470/	180
78/	184	96/7E	242	151	185	473/	179
79/	183	96/7G	242	151/11	189	474/	179
80/	182	96/7I	242	152	185	474/AD	207
85/	143	96/7P	242	153	185	476/	181
87/	179	96/7SF	242	154	185	485/	143
87/6	56 - 237	97/4E	244	155	185	487/	179

499/T	123	4712/	139	AV/1/E	21	CPEI/45/ /E	170
525/	130	4720/	127	AV/1/I	21	CPEI/45/ /G	170
535/	130	4722/	127	AV/2	22	CPEV/45/	169
700/	142	4726/	128	AV/2/E	22	CPEV/45/ /E	170
701/	142	4729/	128	AV/2/I	22	CPEV/45/ /G	170
702/	142	4730/	130	AVK/1	21	CPEV/72/	169
710/	142	4750/	156	AVK/1/E	21	CPEV/72/ /E	170
711/	139	4760/	156	AVK/1/I	21	CPEV/72/ /G	170
712/	139	4780/	156	AVK/2	22	CPGV/55/	167
720/	127	4799/T	123	AVK/2/E	22	CPGV/55/ /E	167
722/	127	4799/TS	123	AVK/2/I	22	CPGV/55/ /G	167
723/	130	7100/	156	AX/2	39	CPHA/	166
724/	130	8580	254	BH/20	116	CPHV/	166
726/	128	8582	254	BH/20/A	116	CPHA/ /E	166
729/	128	8596	254	BI/40	92	CPHV/ /E	166
730/	130	8598	254	BI/40/A	92	CPLB	278
732/SF/	140	8600	253	BL/	94	CPLV/	278
734/A	140	8602	255	BLA/	93	CPLV/ /E	278
735/	130	8602/C	244 - 255 - 256 - 257	BLAH/	93	CPLV/ /G	278
742/	130	8602/E	255	BP/20	116	CPNV/45/	168
750/	156	8602/G	255	BP/20/A	116	CPNV/45/ /E	168
760/	156	8602/I	255	BP/22	115	CPNV/45/ /G	168
774/	82	8602/P dx/sx	255	BP/25	115	CPNVF/45/	168
775/	82	8603	256	BPK/20	116	CR/N	277
776/	82	8603/E	256	BPK/25	115	D/4461/K	286
777/	82	8603/G	256	BPT/20	116	D/4471/K	286
779/SF	82	8603/I	256	BPT/22	115	DA/	121
780/	156	8603/P dx/sx	256	BPT/25	115	DAF/	224
790/ ME	234	8605	217 - 249	C/10/SF	197	DC1	285
790/ MES	234	8607	257	C/13/SF	197	DC10	285
790/ MG	234	8607/E	257	C/22/SF	197	DC2	285
790/ MGS	234	8607/G	257	C/4	203	DC3	285
790/ MI	234	8607/I	257	C/7/SF	197	DC4	285
790/ MIS	234	8607/P dx/sx	257	CE/10/100	59	DC5	285
790/ MP	234	8608	216 - 250	CE/10/20	59	DC7	285
790/ MPS	234	8608/C	216 - 240 - 250 - 251	CE/5/20	59	DCE4	281
790/ SF	234	8610	83 - 253	CE/RGB/20	59	DF	285
799/	125	8611	83 - 253	CLA/	50	DG/	121
799/T/	123	8612/10	218 - 252	CLA/8A	50	DI/	121
799/TP/	123	8613	251	CLA/8P	50	DIMM/02	59
799/TS/	123	8614	252	CN28	285	DJA/	121
799/U/	125	30046	228	CPCI/55/	163	DJA/ /EI	121
4020/	127	30049	228	CPCI/55/ /E	164	DJG/	121
4026/	128	30052	228	CPCI/55/ /G	164	DJG/ /EI	121
4030/	130	AF/1	40	CPCI/75/	163	DJK/	121
4035/	130	AI/	76 - 119 - 214	CPCI/75/ /E	164	DJK/ /EI	121
4040/	130	AIF/	223	CPCI/75/ /G	164	DJJC/10	42
4050/	156	AIL/	76	CPCI/95/	163	DJJC/10	44
4060/	156	AIP/	76	CPCI/95/ /E	164	DJJC/10	43
4080/	156	AIS/	76	CPCI/95/ /G	164	DJN/	121
4150/11/S	189	AIX/	76 - 119	CPCV/30/	165	DJN/ /EI	121
4170/ /S	190	AL/120/24	59	CPCV/30/ /E	165	DK/	121
4300/	142	AL/150/24	59	CPCV/30/ /G	165	DN/	121
4305/	141	AL/2	40	CPCV/55/	163	DNF/	224
4310/	142	AL/60/24	59	CPCV/55/ /E	164	DT1	285
4311/	139	AL/90/24	59	CPCV/55/ /G	164	DT10	285
4312/	139	AQ	24	CPCV/75/	163	DT2	285
4355/	137	AS	23	CPCV/75/ /E	164	DT3	285
4358/	137	AS/E	23	CPCV/75/ /G	164	DT4	285
4399/R/10	124	AS/I	23	CPCV/95/	163	DT5	285
4399/T	123	ASK	23	CPCV/95/ /E	164	DT7	285
4701/	142	ASK/E	23	CPCV/95/ /G	164	FIX/J/30	210
4710/	142	ASK/I	23	CPCVF/55/	163	FIX/J/44	209
4711/	139	AV/1	21	CPEI/45/	169	FIX/L/32	210

FIX/L/55	209	GP/	90	IR/W3	59	NZA/	149 - 211
FIX/T/19	210	GPS/15	108	JGA/	215	NZS/	149
FIX/T/33	209	GPS/6	108 - 109	JGB/	215	NZS/A/40	149
FL/C	282	GPS1/ /19	108	K10	286	NZS/B/	133
FMA/	74	GPS14/12	109	K20-MITRE CUTTER	286	NZS/L/	149
FMAC/	74	GPS2/19	109	KL/1	281 - 282	NZS/S1	133
FMAE/	74	GPS3/ /10	110	KL/1A	281 - 282	NZS/S2	133
FMAI/	74	GPS3/ /12	110	KL/2	281 - 282	P/5	276
FMB/	74	GPS4/ /10	112	KL/3	281 - 282	P1/80	270 - 272 - 274
FMBC/	74	GPS4/ /12	112	KL/C	281	PA/	134
FMBE/	74	GPS4/ /8	112	L5/NW/33	59	PAE	106 - 159
FMBI/	74	GPS5/10/	113	L5/NW/65L	27 - 28	PAI	106 - 159
FMI/	74	GPS5/12/	113	L5/NW/67	59	PAS/	152
FMIC/	74	GPS7/ /19	108	L5/RGB/67	59	POLISHING PASTE	286
FMICS/	74	GPS8/ /10	111	L5/WWW/33	59	PB30	106 - 159
FMIE/	74	GPS8/ /12	111	L5/WWW/67	59	PB5	106 - 159
FMIES/	74	GPS8/ /8	111	LA/I/	64	PBA/	135
FMII/	74	GPU/	90	LA/IS/	64	PBA/5/A	211
FMIS/	74	GR/80/	155	LB/A	63	PBAS/5/F	212
FMIS/	74	GTA/E	87	LB/B/	63	PBE/	151
G/100/	155	GTA/I	87	LDA/	64	PBE30	160
G/2/SF	201	GTIN/C	88 - 89	LDAD	36	PBE5	160
G/4/SF	202	GTIN/E	88 - 89	LDAG/	64	PBH/	152
G/40/	155	GTIN/G	88 - 89	LDB/	64	PCC/01	277
G/460/	155	GTIN/I	88 - 89	LDRS/	64	PCC/02	277
G/60/	155	GTIN/T	88 - 89	LDS/	64	PCC/03	277
G/705/F	213	GTINS/C	88	LDT/	64	PF12	106 - 159
G/8/SF	54	GTINS/E	88	LDTM/	64	PFFE/	153
G/80/	155	GTINS/G	88	LDV/	64	PHDE/	153
G/8B/10	54	GTINS/I	88	LFAG/	64	PI/	91
G/8P/DX	54	GTINS/T	88	LFGBD	46	PIA/	91 - 215
G/8P/SX	54	GTINX/C	88	LFCD	46	PIN/	91
G/9/F	55	GTINX/E	88	LFDBD	46	PLAF/	227
G/9P/DX	55	GTINX/G	88	LFDD	46	PN/	134
G/9P/SX	55	GTINX/I	88	LI	63	PNI/	134
GA/	87 - 215	GTINX/T	88	LIS	63	PNIS/	134
GB/	87	GTL/C	92	LJA	63	PP/96	116 - 160 - 216 - 217 - 253 - 258 - 286
GB/660/	155	GTL/E	92	LKA/	63	PPL/D4	274
GB/880/	155	GTL/I	92	LKB	63	PPL/GM	274
GBL/ /C	93 - 94	GTL/T	92	LKRS	63	PPL/GR	274
GBL/ /E	93 - 94	GTP/C	90	LKTM	63	PPL/T	274
GBL/ /I	93 - 94	GTP/E	90	LLA/20	52	PPL/TA	274
GBL/ /T	93 - 94	GTP/I	90	LLA/20P	52	PPL/TD	272
GF/	227	GTP/T	90	LLA/30	52	PPL/T2	272
GG/2	109	GTV/E	87	LLA/30P	52	PPL/T3	272
GG/3	109	GTV/I	87	LLB/30	52	PPL/T4	272
GG/4	109	GU/30/	114	LLB/30P	52	PR/	134
GIC/	89	GU/40/	114	LQL/2	27	PR30	106 - 159
GIN/	88	GV/	87	LUI/	122	PR5	106 - 159
GINI/	89	GWA/	154	LUIS/	122	PROFLEX MACHINE	228
GINS/	88	H3502	187	MA/	136	PT/4	204
GINX/	88	H/5/F	212	MIN/	80 - 136	PT/4/SA	204
GJA/	154	IL/	84	MN/	136	PTC	284
GJF/	154	ILN/	84	NAN/	147	PTC1	284
GJS/10	154	ILNS/	84	NE/	145	PTC1A	284
GM/10	148	ILNX/	84	NF/	146	PTC2	284
GM/72	183	IP/40	83	NIN/	148	PTC3	284
GM/78	184	IPA/	80 - 174	NJ/	145	PTC4	284
GM/90	239	IPB/	80 - 174	NJ/ /SA	145	PTLP	284
GM/I	147	IPI/	80 - 174	NL/	146	PTWN	284
GM/R	183	IPV/	31	NPAN/	147	PV/	76
GMP/I	147	IR/C01	59	NTA/	148 - 211	PWD12	161
GMR/44	55 - 184	IR/C02	59	NTI/	148 - 211	PWP30	160
GMS/44	184	IR/C03	59	NTO/	148	QDC/1010	104

QDCC/1010	104	SIRS/8/15	175	TIMI/	69	ZG/	119
QDI/1010	104	SIS/	176	TIV/	68	ZGF/	213 - 223
QDL/1010	104	SIS/10/SF	176	TLA/10/C1	52	ZK/	76 - 119
RA/	67 - 214	SIX/	176	TLA/10P/C1	52	ZN/	119
RAF/	224	SKL/2	28	TLB/10/C1	52	ZNF/	223
RAS/	67	SLIM/	100	TLB/10P/C1	52	ZOACD/	45
RB/	67	SLIM/BD01	105	TOP/ /E	85	ZOADD/	45
RC/ /F	208	SLIM/P	105	TOP/ /ETM	85	ZOAGN/	77
RC/411/CV	208	SLIM-I/	100	TOP/ /I	85	ZOAGN/ /EI	78
RC/415/CV	208	SM/	173	TOP/ /ITM	85	ZOAL/10	50
RC/47/CV	208	SMA/	173 - 213	TOP/A/	85	ZOAL/10B	50
RC/49/CV	208	SMART/	102	TOP/TM/	85	ZOAL/10P	50
RC/5/F	212	SMART/BD01	105	TPAE/	71	ZOAMD/	45
RCF/	226	SMART/P	105	TPAI/	71	ZQAN/	77 - 214
RE/	72	SMART3/	102	TPC/410/CV	198	ZQAN/ /EI	78
REC/ /100	73	SMART-I/	102	TPC/413/CV	198	ZQAND/	36
RECO/ /80	73	SN/	174	TPC/47/CV	198	ZQAND/ /EI	36
REL/	72	SNG/	174	TPS/410/CV	200	ZQBN/	77
REM/	72	SP/	177	TPS/413/CV	200	ZQBN/ /EI	78
RI/	69 - 214	SP1	276	TPS/47/CV	200	ZQBRSN/	77
RIC/01	59	SP2	276	TPU/	196 - 196 - 200 - 201 - 202	ZQBRSN/ /EI	78
RIC/RGB/M	59	SP3	276	TPUF/	226	ZQBSN/	77
RIC/RGB/S	59	SS/4	286	TPZ/410/CV	196	ZQBSN/ /EI	78
RIL/	69	SS/5	286	TPZ/413/CV	196	ZQIM/ /EI	78
RIN/	70	STA/	150	TPZ/47/CV	196	ZQIMP/ /EI	78
RINS/	70	STI/	150	TU/6	196 - 198 - 200 - 201 - 202 - 206	ZQIMS/ /EI	78
RINX/	70	STO/	150	TV/	68	ZQIN/	77
RIP/	69	SWA/	177	UA/	122	ZQIN/ /EI	78
RIS/	69	SWB/	177	UA/ /EI	122	ZQINP/	77
RIX/	69	SWC/	177	UG/	122	ZQINP/ /EI	78
RKN/	70	SWP/	136	UG/ /EI	122	ZQINS/	77
RLN/	70	T/	196 - 198 - 200	UI/	122	ZQINS/ /EI	78
RNF/	224	TA/	68	UI/ /EI	122	ZQINX/	77
SLIP-RESISTANT ROLL	181 - 182	TAS/	68	UIS/	122	ZQINX/ /EI	78
RPA/	71	TAT/	68	UIS/ /EI	122	ZQKN/	77 - 214
RR/5	286	TATM/	68	UK/	122	ZQLN/	77
RT/	67	TB/	68 - 70	UK/ /EI	122	ZQLN/ /EI	78
RTM/	67	TE/	73	UKC/10	42	ZQP/	79
RV/	67	TEI/	73	UKG/10	44	ZQP/ /EI	79
RVH/	67	TEL/04	59	UKGC/10	43	ZQTMN/	77
S/15/SF	199	TEL/RGB/04	59	UN/	122	ZQTMN/ /EI	78
S/4	203	TGU/	114	UN/ /EI	122	ZQTN/	77
S/9/SF	199	THIN/	98	VITI	286	ZQTN/ /EI	78
S/95	240 - 241 - 242 - 243 - 245	TIA/	68	XLC/	102	ZQVN/	26 - 30 - 34 - 77
S/97	246	TIAS/	68	XLC3/	102	ZQVN/ /EI	26 - 30 - 34 - 78
SA/	178	TIAT/	68	XLCC/	102	ZQVNH/	77
SA/G	178	TIB/	68 - 70	XLL/	102	ZTM/	75
SAFETY-STEP	187 - 188	TIE/	69	XSC/	100	ZV/	30 - 34 - 75
SAR/10/12	175	TIEL/	69 - 70	XSCC/	100	ZVH/	75
SAR/8/15	175	TIEN/	70	XSL/	100		
SB/	178	TIENS/	70	XTC/	98		
SB/G	178	TIENX/	70	XTCC/	98		
SFL	282	TIEP/	69	XTL/	98		
SGA/	173	TIES/	69	XTT/	98		
SGA/11L	54	TIEX/	69	Z/1/SF	195		
SGA/11P	54	TII/	69	Z/4	203		
SGI/	173	TIIL/	69 - 70	Z3/30/SF	195 - 226		
SGK/	173	TIIN/	70	ZA/	75 - 119 - 214		
SGL/	173	TIINS/	70	ZB/	75		
SGN/	173	TIINX/	70	ZBG/	120		
SI/	176	TIIP/	69	ZBGF/	223		
SIR/10/12	175	TIIS/	69	ZBS/	75		
SIR/8/15	175	TIIX/	69	ZD/	25		
SIRS/10/12	175	TIME/	69	ZDK/	25		

MATERIALS AND CHARACTERISTICS

The following information summarize the main characteristics of the materials. Further information are available upon request of the product specifications.

NATURAL BRASS

Alloy CW624N UNI EN 12167 The profiles are produced by extrusion. They have a good resistance to chemical agents and mechanical stresses. On the visible parts the brass naturally oxidezes that creates a superficial glaze. The brass, when exposed to corrosive agents or high humidity, is subject to phenomena of high oxidation and can present superficial spots. Where necessary, it can be restored to its original state by using abrasives or specific polishing products.

POLISHED BRASS

Alloy CW624N UNI EN 12167 The profiles are produced by extrusion and then mechanically polished. The visible surface must be protected from scratches and frictions. The resistance to chemical agents and mechanical stresses is good. On the visible parts the brass naturally oxidezes that creates a superficial glaze. The brass, when exposed to corrosive agents or high humidity, is subject to phenomena of high oxidation and can present superficial spots. Where necessary, it can be restored to its original state by using abrasives or specific polishing products.

CHROMIUM - PLATED BRASS

Alloy CW624N UNI EN 12167 The profiles are produced by extrusion and then chromed. They are resistant to ultraviolet rays, weathering and chemical agents. They are not suitable for applications in floors with intense mechanical stresses.

NATURAL ALUMINIUM

Alloy of Al-Mg-Si thermically treated in conditions T6 (6060 T6) The profiles are produced by extrusion and guarantee a fair resistance to atmospheric and chemical agents. The cement and its derivates produce, if wet, alkaline substances that, acting on the surface, can corrode the metal (formation of hydroxide of aluminium). For that reason, the visible surface of the profile must be immediately cleaned from cement, glue and other materials used for joints.

ANODISED ALUMINIUM

Alloy of Al-Mg-Si thermically treated in conditions T6 (6060 T6) The profiles are produced by extrusion and then anodised. They have a good resistance to atmospheric and chemical agents. The cement and its derivates produce, if wet, alkaline substances that, acting on the surface, can corrode the metal (formation of hydroxide of aluminium). For that reason, the visible surface of the profile must be immediately and gently cleaned from cement, glue and other materials used for joints. Wear and pedestrian traffic could damage the surface (in cases of profiles layed on the floor) and remove the original anodised finish.

POLISHED ALUMINIUM

Alloy of Al-Mg-Si thermically treated in conditions T6 (6463 T6) The profiles are produced by extrusion and then mechanically treated and processed. They guarantee a fair resistance to atmospheric and chemical agents. The cement and its derivates produce, if wet, alkaline substances that, acting on the surface, can corrode the metal (formation of hydroxide of aluminium). For that reason, the visible surface of the profile must be immediately and gently cleaned from cement, glue and other materials used for joints. Polished aluminium profiles are not suitable for floor applications.

COLOUR - COATED ALUMINIUM

Alloy of Al-Mg-Si thermically treated in conditions T6 (6060 T6) The profiles are made by extrusion and then coated with a thickness of $\geq 80 \mu\text{m}$. They have

a fair resistance to atmospheric and chemical agents while they do not have a good resistance to mechanical stresses that would damage the surface enamel; therefore they are not recommended for floor applications. For that reason, the visible surface of the profile must be immediately and gently cleaned from cement, glue and other materials used for joints.

ALCROM® PLUS FOILED ALUMINIUM

Alloy of Al-Mg-Si thermically treated in conditions T6 (6060 T6) The profiles are produced by extrusion in natural alloy. The wood decoration is obtained by foiling the aluminium profiles with a special film Alcrom® Plus, resistant to wear, perfectly reproducing grains and colours of wood.

STAINLESS STEEL - AISI 430 - DIN 1.4016

This kind of stainless steel has a moderate resistance to corrosive agents. We recommend its use exclusively for indoor use.

STAINLESS STEEL - AISI 304 - DIN 1.4301 V2A

It is extremely resistant to most chemical and atmospheric agents, lime, mortar, tile glue and common cleaning products. It is recommended for outdoor use, food processing industry, hospitals, etc.

STAINLESS STEEL - AISI 316 – DIN 1.4404 V4A

It is extremely resistant to most chemical and atmospheric agents, lime, mortar, tile glue and common cleaning products. Moreover it has a good resistance to chlorine and salt. Particularly indicated in extreme conditions of use.

LAYING - WARNINGS:

even stainless steel can be damaged if not treated with proper precautions during the laying stages. In particular, pay attention to: keeping the profiles protected inside their individual packaging up until the installation. (this precaution allows to avoid the contamination with other ferrous materials during the transport). Avoiding the direct contact with cleaning products for cotto tiles and marble, decalcifying agents and cleansers containing chlorine and its compounds. Pay attention to the gases of hydrochloric acid which may develop during the cleansing of special floors. After the laying, proceed immediately with an accurate cleaning of the surface with plenty of water and the consequent drying.

MAINTENANCE:

the frequent cleaning is essential to preserve the beauty of stainless steel profiles surfaces. Pay close attention to the treatment of the profiles' surface during the installation. Immediately after installation, clean by rinsing the surfaces accurately. Avoid the use of abrasive products that may scratch the profile. Do not use cleansers containing chlorine and its compounds, such as bleach, muriatic acid, decalcifying agents. Do not use abrasive sponges or wire wools that may scratch the surface or leave rust stains.

CHROMIUM-PLATED STAINLESS STEEL - AISI 304 - DIN 1.4301 (profilpas design)

It has a refined aesthetic value. It is suitable for wall coverings but not for floors: the cleaning maintenance should be done with sponges or soft and non-abrasive cloths. We suggest to use neutral detergents.

Rigid PVC

Vinyl compound of rigid PVC unleaded, anti shock, non-flammable. Mixture eco-friendly with Ca-Zn salts.

Plasticized PVC

Vinyl compound of plasticized PVC unleaded, non-flammable. Mixture eco-friendly with Ca-Zn salts.

Foam PVC

Vinyl compound of plasticized PVC unleaded, non-flammable. Mixture eco-friendly with Ca-Zn salts.

Co-extruded PVC - Rigid/Rigid

Vinyl compound of rigid PVC unleaded, anti-shock non-flammable. Mixture eco-friendly with Ca-Zn salts.

Co-extruded PVC - Plasticized/Plasticized

Vinyl compound of plasticized PVC unleaded, non-flammable. Mixture eco-friendly with Ca-Zn salts.

Co-extruded PVC - Rigid/Plasticized

Vinyl compound of rigid PVC unleaded, anti-shock, non-flammable. Mixture eco-friendly with Ca-Zn salts. Vinyl compound of plasticized PVC unleaded, non-flammable. Mixture eco-friendly with Ca-Zn salts.

Co-extruded PVC - Rigid/Plasticized anti-mould

Vinyl compound of rigid PVC unleaded, anti-shock, non-flammable. Mixture eco-friendly with Ca-Zn salts. Vinyl compound of plasticized PVC unleaded, non-flammable, addicted with biocide. Mixture eco-friendly with Ca-Zn salts.

Co-extruded PVC - Foam/Plasticized

Vinyl compound of foam PVC unleaded, non-flammable. Mixture eco-friendly with Ca-Zn salts. Vinyl compound of plasticized PVC unleaded, non-flammable. Mixture eco-friendly with Ca-Zn salts.

ADVICES FOR CLEANING AND MAINTENANCE

MATERIAL	FINISHING	CLEANING AFTER LAYING	MAINTENANCE
aluminium	anodised	Use of acid based cleaners and not alkaline	exclusive use of neutral cleaning products
aluminium	bril. polished	Use of acid based cleaners and not alkaline	exclusive use of neutral cleaning products
aluminium	bright polished copper	Use of acid based cleaners and not alkaline	exclusive use of neutral cleaning products
aluminium	bright polished titanium	Use of acid based cleaners and not alkaline	exclusive use of neutral cleaning products
aluminium	bright polished gold	Use of acid based cleaners and not alkaline	Exclusive use of neutral cleaning products
aluminium	color-coated	Use of acid based cleaners	use neutral or alkaline detergents
aluminium	bright satin	Use of acid based cleaners and not alkaline	exclusive use of neutral cleaning products
aluminium	riv. Alcrom Plus	Use of acid based cleaners	Exclusive use of neutral cleaning products
stainless steel	polished	Use of acid based cleaners without chlorine	use neutral or alkaline detergents
stainless steel	Inox AISI 316	Use of acid based cleaners	exclusive use of neutral cleaning products
stainless steel	sandblast	Use of acid based cleaners only neutral	use neutral or alkaline detergents
stainless steel	satin	Use of acid based cleaners without chlorine	use neutral or alkaline detergents
brass	natural	Use of acid based cleaners only neutral	exclusive use of neutral cleaning products
brass	polished	Use of acid based cleaners only neutral	exclusive use of neutral cleaning products
brass	chromium - plated	Use of acid based cleaners	use neutral or alkaline detergents
PVC		Use of acid based cleaners and not alkaline	exclusive use of neutral cleaning products

PROFILES CHARACTERISTICS AND PACKAGING

SELF-ADHESIVE PROFILES

Self-adhesive profiles are made of non-toxic, non-flammable and solvent free hot-melt glues. Although these products are non-flammable, it is recommended not to expose them to naked flames. Product preservation is guaranteed when stored in "normal" climatic conditions.

Glue deteriorates at temperatures over +90°C and crystallizes at temperatures below -15°C. During the application, the temperature of self-adhesive profiles and the ambient temperature where profiles have to be laid should not be below +10°C.

Important: self-adhesive profiles cannot be laid on friable supports, as junction between two carpet floors or between PVC floors and wall coverings.

DRILLED PROFILES

Screw-mounted profiles are drilled according to the model and the material at issue, so that to lodge 3 mm or 3,5 mm screws, either flat-head or round-head ones.

PROSYSTEM® PROFILES Prosystem is fixed without screws. The profiles have a longitudinal channel in which nylon dowels or an aluminium base are inserted.

PACKAGING

The  means blister packaging.

"Individually packed" means that the packaging is made for the single profile with a protective heat shrink film.

MEASURES - TOLERANCES - REFERENCES NORMS - CERTIFICATION ON PRODUCT

Please note that the information and the drawings in the present catalogue are not binding.

The data about measures, such as length, thickness and width refer to nominal measures. The foreseen tolerances, the related norms and reference certifications are indicated in the specifications of products, available on request.

DIRECTIONS

The resistance to chemical products depends on their degree of chemical aggressiveness and therefore it is necessary to make sure in advance of the effects that products used for profile laying, cleaning and maintenance can produce. In particular lime, mortar or tile glue cause strains on the visible surface of profiles. Therefore it is necessary to clean these parts immediately after the laying of the profiles. Please note that in the present catalogue, due to the printing, the colour shades can be slightly different from the real ones.

GENERAL CONDITIONS OF SALE

These General Conditions shall govern all sales contracts executed between Profilpas S.p.A. and the Buyer and shall prevail on all the Buyer's general or individual purchasing conditions. Any derogation to these General Conditions shall be binding on Profilpas only if accepted in writing by the latter.

1. Prices

The prices shown in Profilpas' price list are in Euro per meter but products will be invoiced in Euro per piece with the discounts granted in accordance with the ordered quantities or upon agreement with Profilpas. Prices are exclusive of additional taxes or customs duties. Profilpas expressly reserves the right to modify the prices without notice, in accordance with any fluctuation in the costs of raw materials.

2. Minimum orders

The required minimum order value is fixed at the amount of Euro 500,00.

3. Orders

Purchase orders must be sent in writing. Orders shall be deemed accepted and binding on Profilpas only after receipt by the Buyer of Profilpas' written order confirmation. Only the discounts and the prices indicated in the order confirmation shall be binding for Profilpas. Should the order confirmation contain amendments with respect to the Order, such amendments shall be deemed tacitly accepted by the Buyer after 5 (five) days from receipt of the order confirmation unless the Buyer notifies its disagreement in writing within the above-mentioned term.

4. Delivery terms

Deliveries shall be made EX WORKS (Incoterms 2010) Profilpas warehouse in Cadoneghe (Padova) - Italy. The products shall always be transported at the Buyer's risk according to the Incoterms, and any reimbursements for damages shall be claimed by the Buyer to the carrier in accordance with the relevant agreements and clauses contained in the stipulated insurance policies. Delivery dates are estimated and not guaranteed. Profilpas shall not be responsible for any delay nor for the consequences thereof. In case of delay in delivery, the Buyer shall not have the right to terminate the sales agreement and/or obtain compensation of any direct, indirect or consequential damage suffered, unless in case of intent or gross negligence.

5. Packaging

Prices include Profilpas standard packaging. Sea shipment packaging or any other special packaging requested by the Buyer will be charged at cost. Profilpas' catalogue indicates which products have partial packaging and the surcharge applied in such case. In case of products without partial packaging, Profilpas can exceptionally sell them with partial packaging, charging the price on the pricelist without discount.

6. Terms of payment

All payments must be made in accordance with the agreed terms of payment; the relevant sums must be transferred to the bank indicated by Profilpas. In case of delay of payment, whether total or partial, the Buyer shall be bound to pay interest on all outstanding amounts calculated according to art. 5 of Italian Legislative Decree no. 231/2002 or subsequent modifications.

Delay or non-payment of any sums due by the Buyer to Profilpas, even if concerning different contractual relationships, shall entitle Profilpas to suspend the preparation and delivery of the products which are the object of the order and of any other order in progress.

7. Claims

Claims must be notified in writing to Profilpas within 10 days from the delivery date. Claims for damaged, stolen or missing products shall be lodged with the carrier upon receipt of the products. If no written

complaint is lodged with the carrier, Profilpas will not accept any return or replacement of the delivered products. Return of products will only be accepted upon Profilpas' prior written consent and always at the Buyer's expense.

8. Retention of title (article 1523 of the Italian Civil Code)

The products shall remain the property of Profilpas until full payment. Non-compliance, or partial compliance, of the agreed payment terms allow Profilpas, without prejudice to any other claim it may have, to recover the products supplied, even if transferred to third parties. The Buyer is liable for any damage to the products due to poor storage or negligence and shall be responsible as a depository. Profilpas does not assume responsibility for damage to the products consequential or subsequent to the installation of the same.

9. Warranty and defects

Profilpas guarantees that the products are free from defects in material and workmanship for a period of 12 months from the date of delivery to the Buyer. Should Profilpas acknowledge the existence of the claimed defects, and provided that it has been promptly notified in accordance with the above mentioned paragraph "Claims", Profilpas' warranty shall be limited, at its discretion, to the replacement of the defective products, free of charge EXW Profilpas' premises (Incoterms 2010), within the normal time required therefor, or to the issue of a credit note for the amount of the defective products, ANY OTHER LEGAL OR CONVENTIONAL WARRANTY OR CLAIMS FOR ANY FURTHER DIRECT, INDIRECT OR CONSEQUENTIAL DAMAGES SUSTAINED BY THE BUYER OR THIRD PARTIES, UNLESS IN CASE OF INTENT OR GROSS NEGLIGENCE, BEING EXPRESSLY EXCLUDED.

The Buyer expressly waives its right of regress according to article 131 of the Italian Consumers' Code.

No products will be returned by the Buyer without prior written permission by Profilpas. Profilpas does not guarantee the compliance of the products to any particular specifications or technical characteristics or their suitability for any use and/or special uses if not to the extent that such characteristics have been expressly agreed in the sales contract. Profilpas is not liable for damages that the Buyer, or third parties, generate by using the products if the damage does not depend on the quality or intrinsic characteristics of the product, but by the choice of purchase and usage of the same by the Buyer.

10. Industrial and intellectual property

Profilpas Spa's trademarks, distinguishing signs, designs, photographs of products and/or production and commercial technology shall be considered strictly confidential and shall not be used without prior written authorisation from the same.

11. Express delivery

Upon the Buyer's request, Profilpas can offer a service of express delivery. The surcharge for this express service will be communicated with the order confirmation.

12. Privacy

Personal and fiscal details which may be acquired directly by Profilpas spa (Via Einstein 38 - Cadoneghe), the data controller, or via third parties, shall be used for contractual purposes, pursuant to law, to manage business relations and promote sales. Said data may be communicated to third parties both in Italy and abroad such as Profilpas spa's network of sales representatives, financial institutions, factoring companies, insurance, debt recovery and business information companies as well as professionals, management consultants and carriers.

13. Final clauses

Profilpas sales are governed by the laws of Italy. In case of dispute, the courts of Padua - Italy shall be the exclusive competent venue.

